



ENGLISH TRANSLATION

**RECEIVER FOR DIGITAL
BROADCASTING**

**ARIB STANDARD
(DESIRABLE SPECIFICATIONS)**

ARIB STD-B21 Version 4.6

Established on October 26, 1999	Version 1.0
Revised on May 29, 2000	Version 1.1
Revised on December 14, 2000	Version 1.2
Revised on March 27, 2001	Version 2.0
Revised on May 31, 2001	Version 3.0
Revised on January 24, 2002	Version 3.1
Revised on July 25, 2002	Version 3.2
Revised on February 6, 2003	Version 4.0
Revised on June 5, 2003	Version 4.1
Revised on October, 16 2003	Version 4.2
Revised on May 25, 2004	Version 4.3
Revised on September 29, 2005	Version 4.4
Revised on September 28, 2006	Version 4.5
Revised on March 14, 2007	Version 4.6

Association of Radio Industries and Businesses

General Notes to the English translation of ARIB Standards and Technical Reports

1. The copyright of this document is ascribed to the Association of Radio Industries and Businesses (ARIB).
2. All rights reserved. No part of this document may be reproduced, stored in a retrieval system, or transmitted, in any form or by any means, without the prior written permission of ARIB.
3. The ARIB Standards and ARIB Technical Reports are usually written in Japanese and approved by the ARIB Standard Assembly. This document is a translation into English of the approved document for the purpose of convenience of users. If there are any discrepancies in the content, expressions, etc., between the Japanese original and this translated document, the Japanese original shall prevail.
4. The establishment, revision and abolishment of ARIB Standards and Technical Reports are approved at the ARIB Standard Assembly, which meets several times a year. Approved ARIB Standards and Technical Reports, in their original language, are made publicly available in hard copy, CDs or through web posting, generally in about one month after the date of approval. The original document of this translation may have been further revised and therefore users are encouraged to check the latest version at an appropriate page under the following URL:

<http://www.arib.or.jp/english/index.html>

TOTAL CONTENTS

Foreword

Receiver for Digital Broadcasting..... 1

Appendix: Commentary and Guidelines 165

Foreword

The ARIB (Association of Radio Industries and Businesses) has established the "ARIB standard" for the basic technical condition of standard specifications related to each radio communication equipment using radio wave and broadcasting transmission and reception equipment, with the participation of radio communication equipment manufacturers, broadcasting equipment manufacturers, electric communication companies, broadcasting companies and other users.

"ARIB standard" is a nonofficial standard established by combining governmental technical standards established for the more effective use of frequencies and to avoid interference among users, and nonofficial optional standards established for the convenience of radio communication equipment manufacturers, broadcasting equipment manufacturers, electric communication companies, broadcasting companies and users, in order to secure appropriate quality and compatibility of radio communication equipment and broadcast equipment, etc.

In order to secure fairness and transparency in drafting steps, this standard is drafted in response to a consensus of the standardization committee, with the participation of interested parties such as radio communication equipment manufacturers, broadcasting equipment manufacturers, electric communication companies, broadcasting companies, and interested users.

At this standardization committee, "Operational standard of basic construction and identifier of service information for digital broadcasting" (ARIB STD-B2), which was the standard specification related to basic construction of service information necessary to enable users to select programs, for the implementation of digital broadcasting, was established as the standard method in Japan, in May 29, 1996. As for the practical use of this standard, a data construction detail standard of service information and guideline for actual operation is necessary in addition to basic construction, so this standard, "Service information for digital broadcasting system", is established as a new nonofficial standard combining the standards mentioned above.

This standard consists of three parts. The first part includes references to other standards related to digital broadcasting and lists of tables and descriptors used in digital broadcasting, in addition to the former standard (ARIB STD-B2). The second part specifies the basic information of service information. The third part specifies the detail data construction of extension of the service information. Guidelines of operational method of service information are attached to this standard as technical documents.

Please note that in accordance with the establishment of the new standard, the former "Operational standard of basic construction and identifier of service information for digital broadcasting" (ARIB STD-B2) (May 29, 1996) is abolished.

Service information established herein considers wide application to total broadcasting media such as CS broadcasting, BS broadcasting and digital broadcasting on the ground, preconditioning international coordination of signal structure, flexibility of program organization in each broadcasting company, and the possibility of expansion for future broadcasting service development. From now on, addition or revision of characteristic information and signals may become necessary, depending upon future developments in these broadcasting media.

We hope that this standard will be used actively among radio communication equipment manufacturers, broadcast equipment manufacturers, electric communication companies, broadcasting companies and other users.

Notice:

This standard does not describe industrial proprietary rights mandatory to this standard. However, the owner of industrial proprietary rights is expressed as "Industrial proprietary rights related to this standard, listed in the Annex below, are possessed by the applicant shown in the list. However, execution of the rights listed in the Annex below is permitted indiscriminately, without exclusion, under appropriate conditions, to the user of this standard. If the user of this standard possesses the mandatory industrial proprietary rights for all or part of the contents specified in this standard, and when he asserts those rights, it is not applicable."

Annexed table

Patent Applicant/Holder	Name of Invention	Application No., etc.	Remark
Matsushita Electric Co.	Digital broadcasting method and receiver system	Patent Application H10-28372	Japan
	Broadcasting system and receiver	Patent Application H10-195093	Japan
	Channel setting method and digital broadcasting receiver system (*)	Patent Application 2000-15076	Japan
NHK	Broadcasting receiver	Patent 2592462	Japan
	Broadcasting receiver	Patent 2945670	Japan
	Integrated broadcasting receiver	Patent release H9-312811	Japan
	Absolute phase detector and digital modulation wave demodulator	Patent release H9-186730	Japan
	Digital transmission method and transmission and reception device	Patent release H9-321813	Japan
	AFC circuit, carrier demodulation circuit and receiver	Patent release H11-98432	Japan, US, etc.
	Hierarchical transmission digital demodulator	Patent release H11-163957	Japan
	Digital broadcasting receiver	Patent release H11-168520	Japan
	Transmission and reception device	Patent release H11-177537	Japan, US, etc.
	Digital data receiver	Patent 2912323	Japan, US, etc.
	Receiver	Patent release 2000-4409	Japan
	Digital transmission and reception device	Patent 2991694	Japan
	Digital broadcasting receiver	Patent Application H10-313154	Japan, US, etc.
	Synchronization regeneration circuit	Patent 3017983	Japan
	Error correction circuit (*4)	Patent 1585258	Japan
	Error correction system (*4)	Patent 1587162	Japan, US, Canada, Korea
	Error detection circuit (*4)	Patent 1587174	Japan, US
	Error correction and decoding system (*4)	Patent 1707686	Japan, US, Canada, Korea
	Orthogonal frequency division multiplex digital signal transmission and reception device (*4)	Patent 2904986	Japan, US, UK, Germany, France
	Coded modulation device and demodulation device (*4)	Patent 2883238	Japan
Broadcasting method and transmitter-receiver (*4)	Patent release H8-294098	Japan	
Methods and devices for transmitting and receiving digital signal (*4)	Patent release H9-46307	Japan	
Digital signal transmission method and receiver (*4)	Patent release H10-93521	Japan	

Patent Applicant/Holder	Name of Invention	Application No., etc.	Remark
	Digital signal transmitter and digital signal receiver (*4)	Patent release H10-336158	Japan
NHK	Orthogonal frequency division multiplex transmission system, transmission equipment and reception equipment (*4)	Patent 3083159	Japan, China, Korea Taiwan
	Digital signal receiver (*4)	Patent 2975932	Japan
	Transmitter and receiver (*4)	Patent release 2000-101543	Japan
	Orthogonal frequency division multiplex transmission system, transmission equipment and reception equipment (*4)	Patent release 2000-236313	Japan
	OFDM receiver (*4)	Patent release H11-355240	Japan
	OFDM signal demodulator (*4)	Patent release 2000-13353	Japan
Casio Computer Co.	Receiver	Patent Application S60-200035	Japan
	Channel selecting program device for television receiver	Patent Application S60-200040	Japan
	Program information transmission and reception system	Patent Application S60-200033	Japan
NEC Corp.	Motion compensation inter-frame estimation coding-encoding method and equipment of picture signal (*1)	Patent 1890887	Japan
	Reproducing method for compressedly recorded picture (*1)	Patent 2119938	Japan, US, UK, Germany, France, Holland, Canada
	Interactive reproducing system for compressedly recorded picture (*1)	Patent 213485	Japan, US, UK, Germany, France, Holland, Canada
	Method and device for adaptive transformation coding/decoding (*1)	Patent 2638208	Japan, US, UK, Germany, France
	Coding system and decoding system(*1)	Patent 2820096	Japan, Korea, Australia
	Frame synchronization control circuit (*4)	Patent 2998716	Japan
	Guard interval correlator and its correlation acquisition method (*4)	Patent 3082757	Japan
	Orthogonal frequency division multiplex demodulator and correction method for phase errors in symbol in orthogonal frequency division multiplex demodulation (*4)	Patent 3090137	Japan

Patent Applicant/Holder	Name of Invention	Application No., etc.	Remark
JVC	Reproduction protection method and protection reproducing device (*2)	Patent 2853727	Japan, US, Germany, UK, France, Korea India, China
	Information recording method and information recording medium (*2)	Patent 3102416	Japan
	Orthogonal frequency division multiplex signal transmitter-receiver (*4)	Patent 2790239	Japan, US, UK, Germany, France
	Orthogonal frequency division multiplex signal transmitter-receiver (*4)	Patent 2874729	Japan, US
	Quadrature frequency division multiplexing signal transmitter-receiver (*4)	Patent 3055540	Japan
	Orthogonal frequency division multiple signal transmitter-receiver (*4)	Patent 3055541	Japan
	Orthogonal frequency division multiplex signal transmission and reception system	Patent release 2000-224142	Japan
Maspro Denkoh Corp.	Satellite reception converter (*3)	Patent Application H11-325803	Japan
	Satellite reception converter, block converter, down converter, and satellite reception system (*3)	Patent Application 2000-177344	Japan
DTV-Lab	Comprehensive confirmation of ARIB STD-B21 Version 3.0 is submitted (*4)		
Motorola Japan Ltd.	Comprehensive confirmation of ARIB STD-B21 Version 4.0 is submitted(*5)		
	Comprehensive confirmation of patents for ARIB STD-B21 Version 4.2 is submitted(*6)		
	Comprehensive confirmation of patents for ARIB STD-B21 Version 4.3 is submitted(*7)		
Philips Japan Ltd.	Comprehensive confirmation of patents for ARIB STD-B21 Version 4.3 is submitted(*7)		
(株)フィリップスエレクトロニクスジャパン	Comprehensive confirmation of patents for ARIB STD-B21 Version 4.4 is submitted(*8)		

(*) This is effective for the revised portion for ARIB STD-B21 version 1.1.

(*1) This is effective for the revised portion of ARIB STD-B21 version 1.1(submitted December 14, 2000)

(*2) This is effective for ARIB STD-B21 versions 1.0 and later (submitted Mach 15, 2001)

(*3) This is effective for the revised portion of ARIB STD-B21 version 2.0.

(*4) This is effective for the revised portion of ARIB STD-B21 version 3.0.

(*5) This is effective for the revised portion of ARIB STD-B21 version 4.0.

(*6) This is effective for the revised portion of ARIB STD-B21 version 4.2 (accepted on October 9, 2003).

(*7) This is effective for the revised portion of ARIB STD-B21 version 4.3 (accepted on March 30, 2004).

(*8) This is effective for the revised portion of ARIB STD-B21 version 4.4 (accepted on September 27, 2005).

CONTENTS

Chapter 1:	General matters.....	1
1.1	Objective.....	1
1.2	Scope.....	1
1.3	Related documents	1
Chapter 2:	Configuration of the receiver.....	3
Chapter 3:	Ambient conditions.....	5
Chapter 4:	Ratings and specifications of the units of the digital satellite broadcasting receiver....	6
4.1	Satellite receiving antenna.....	6
4.2	Converter	6
4.3	Coupling cable	7
4.4	Specifications of DIRD	7
4.4.1	IF input.....	7
4.4.2	Intermediate frequency.....	7
4.4.3	Bandwidth of the intermediate frequency.....	7
4.4.4	Second local oscillator frequency.....	7
4.4.5	Front-end signal processing.....	7
4.4.6	Transport processing.....	8
4.4.7	Conditional access	8
4.4.8	Memories.....	8
4.4.9	Video decoding and its output.....	9
4.4.10	Audio decoding and its output.....	9
4.4.11	Primary data decoder.....	9
4.4.12	EPG function.....	9
4.4.13	High-speed digital interface.....	9
4.4.14	CA module interface	9
4.4.15	External interfaces	9
4.4.16	Remote controller and channel access	10
Chapter 5:	Ratings and specifications of the receiving units for the digital terrestrial television broadcasting.....	11
5.1	Receiving antenna	11
5.2	Specifications of the DIRD.....	12

5.2.1	Input	12
5.2.2	First intermediate frequency	12
5.2.3	Synchronization range of the received frequency	12
5.2.4	Synchronization range of the received clock.....	12
5.2.5	Characteristics of the tuning unit	13
5.2.6	Front-end signal processing.....	14
5.2.7	Transport processing	17
5.2.8	Conditional access	17
5.2.9	Memories	17
5.2.10	Video decoding and its output.....	18
5.2.11	Audio decoding and its output	18
5.2.12	Primary data decoder	18
5.2.13	EPG function.....	18
5.2.14	High-speed digital interface.....	18
5.2.15	CA module interface	18
5.2.16	External interfaces	18
5.2.17	Remote controller and channel access	19
5.3	Analog broadcast receiving function.....	19
Chapter 6:	Decoding process of video and audio and output signals	20
6.1	Video decoding process and output signals	20
6.1.1	Video decoding process	20
6.1.2	Video output signals	23
6.1.3	Video-signal output.....	29
6.1.4	Copy protection	31
6.2	Audio decoding process and output.....	32
6.2.1	Audio decoding process	32
6.2.2	Audio mode discrimination and indication.....	34
6.2.3	Audio output	34
6.3	Receiver's function of hierarchical modulation in digital satellite broadcasting	35
6.3.1	Hierarchical modulating signal.....	35
6.3.2	Identification of hierarchical modulation	35
6.3.3	Reception processing of hierarchical modulation.....	35
6.3.4	Display of low-hierarchy video in hierarchical modulation.....	35
6.4	Indication of MP@LL animation and still picture in digital terrestrial television broadcasting.....	44
6.4.1	Operation of MP@LL animation and still picture.....	44
6.4.2	Indication for the receiver.....	44

Chapter 7: Specifications of the primary data decoder	52
Chapter 8: Specifications of EPG	53
Chapter 9: Specifications for high-speed digital interfaces	54
9.1 Specifications of the serial interface	54
9.1.1 Signal name, functions, and pin layout of the interface	54
9.1.2 Signal voltage level and impedance	54
9.1.3 Connector	55
9.1.4 Protocol of the serial interface	55
9.1.5 Descriptors, commands, and tuner models	55
9.1.6 I/O transport stream of serial interface	90
9.1.7 Basic construction of the service information and operation standard of descriptors on the serial interface	90
9.1.8 Data structure and definition of service information on the serial interface	94
9.1.9 Guidelines for operating procedures for tables used in the partial transport stream	102
9.2 IP interface specifications	103
9.2.1 Physical interface protocol stack specifications	103
9.2.2 Content output specifications	104
9.2.3 Tuner description specifications	105
9.2.4 Control of content selection	107
Chapter 10: Specifications of CA module interface	109
Chapter 11: Specifications of bidirectional communication function	110
11.1 Transmission phases in bidirectional communication	110
11.1.1 Line connecting/cutting phase	110
11.1.2 Link establishing/terminating phase	110
11.1.3 Data transfer phase	110
11.2 Viewing information collection protocol	111
11.2.1 Protocol of link establishing/terminating phase	111
11.2.2 Protocol of data transferring phase	111
11.2.3 Sequence	111
11.3 Data broadcasting service and data distribution protocol	112
11.3.1 Protocol for link establishing/terminating phase	112
11.3.2 Protocol of data transfer phase	112
11.4 Interfaces	119

11.4.1	Subscriber telephone line (PSTN) interface	119
11.4.2	ISDN interface	120
11.4.3	Ethernet interface	122
11.4.4	Portable phone/PHS(PIAFS) interface.....	122
11.5	Necessary functions for bidirectional communication with use of TCP/IP	123
11.5.1	Automatic connecting function	123
11.5.2	Automatic disconnecting function	123
11.5.3	Setting function for viewer-set information elements	123
11.5.4	Communication security function	123
11.5.5	Presenting function	124
11.5.6	Line cutting function	124
11.5.7	Maintaining information elements for bidirectional connection	124
Chapter 12:	Downloading function	131
12.1	Definitions of terms and service content	131
12.1.1	Definitions of terms	131
12.1.2	Service contents	131
12.2	Transmission scheme relevant to downloading	132
12.2.1	Transmission scheme of notification information	132
12.2.2	Transmission scheme of the content	138
12.3	Preferable specifications of the receiver	144
12.3.1	Necessary functions.....	144
12.3.2	Necessary capacity and performance of receiver hardware	145
Chapter 13:	Signal processing functions of DIRD	146
13.1	Service information	146
13.2	Identification between broadcasting and non-broadcasting	146
13.3	Number of PIDs to be simultaneously processed.....	146
13.4	Number of scramble keys that can be set for scrambling	146
13.5	Flow of program selection	146
Chapter 14:	Performance of receiver units.....	149
14.1	Satellite receiving antenna.....	149
14.2	Satellite converter	150
14.3	Satellite DIRD	150
Chapter 15:	Receiver compatible with other media (option).....	151

15.1	Making the digital broadcast receiver compatible with other media and the interoperability connection unit	151
15.1.1	Enabling the digital satellite broadcast receiver to receive digital terrestrial television broadcasts receiving adapter and interoperability connection unit.....	151
15.2	Baseband unit.....	158
Chapter 16:	Server-type broadcast receiving function	159
16.1	Basic configuration of the server-type broadcast receiver	159
16.2	Specifications of server-type broadcast receiver components	160
16.2.1	Accumulation function	160
16.2.2	Video signal processing and output types	160
16.2.3	Audio decoding and output	160
16.2.4	Specifications of bidirectional communication function	160
16.3	Signal processing function of the server-type broadcast receiver.....	160
16.3.1	Flow of content accumulation.....	160
16.3.2	Flow of selecting accumulated contents.....	160
Chapter 17:	Rights protection function	164

<Blank Page>

Chapter 1: General matters

1.1 Objective

Standard is to define the basic functions, ratings, and performance of receivers for digital broadcasting.

1.2 Scope

This ARIB standard applies to: receivers for digital broadcasting among the various types of standard television broadcasting, high-definition television broadcasting, ultra-high-frequency wave broadcasting, and data broadcasting carried out by broadcasting satellite stations in the frequency band of 11.7–12.2 GHz (hereinafter referred to as “BS digital broadcasting”); receivers for standard television broadcasting, high-definition television broadcasting, ultra-high-frequency wave broadcasting, and data broadcasting with a bandwidth of 34.5 MHz carried out by broadcasting satellite stations in the frequency band of 12.2–12.75 GHz (hereinafter referred to as “broadband CS digital broadcasting”); and receivers for digital broadcasting and high-definition television broadcasting among the various types of standard television broadcasting carried out by broadcasting stations (hereinafter referred to as “digital terrestrial television broadcasting”).

With regard to the receiver, it may be designed for receiving only one broadcast service from among the above-mentioned digital broadcasting or for receiving multiple broadcast services. Likewise, various types of receivers for receiving digital terrestrial television broadcasts may be designed, that is, receivers intended for fixed stations, for a mobile stations, and for portable reception.

This ARIB standard defines the BS digital-broadcasting receiver, the double-purpose receiver for BS digital broadcasting and the broadband CS digital-broadcasting receiver (hereinafter referred to as a “BS and broadband CS digital-broadcasting dual-purpose receiver”), as well as the standard receiver that receives digital terrestrial television broadcasting using an outdoor fixed receiving antenna and represents it on a large display. For a small-sized simple receiver, a vehicle-mounted receiver, a portable receiver, and the like, this ARIB standard must be applied correspondingly or referred to.

In this standard, the BS digital-broadcasting receiver and the BS and broadband CS digital-broadcasting dual-purpose receiver are generically described as digital satellite broadcasting receivers.

In addition, when it is necessary to distinguish between the BS digital-broadcasting receiver and the BS and broadband CS digital-broadcasting dual-purpose receiver, [BS] is additionally used to specify a BS digital-broadcasting receiver, and [BS · CS] is used likewise to specify a BS and broadband CS digital-broadcasting dual-purpose receiver.

1.3 Related documents

- (1) Report of the Telecommunications Technology Council Consultation No. 74
- (2) Report of the Telecommunications Technology Council Consultation No. 98
- (3) ARIB STD-B1, “Receiver for CS Digital Broadcasting”
- (4) ARIB STD-B10, “Specification for Service Information in Digital Broadcasting”
- (5) ARIB STD-B16, “Standard Common Receiver for CS Digital Broadcasting”
- (6) ARIB STD-B20, “Standard Specification of Sending and Operation Condition of Broadcast Satellite Digital Broadcasting”
- (7) ARIB STD-B24, “Data broadcast Coding and Transmission Specification for Digital Broadcasting”

- (8) ARIB Standard B25, “Access Control System for Digital Broadcasting”
- (9) ARIB Standard B29, “Transmission System for Digital Terrestrial Audio Broadcasting”
- (10) ARIB Standard B30, “Receiver for Digital Terrestrial Audio Broadcasting”
- (11) ARIB Standard B31, “Transmission System for Digital Terrestrial Television Broadcasting”
- (12) ARIB Standard B32, “Picture and Audio Coding and Multiplexing Schemes for Digital Broadcasting”

Chapter 2: Configuration of the receiver

The basic configuration of the “receiver” specified here is shown in Fig. 2-1.

(1) The satellite receiver is composed of the following units:

- 1) Satellite receiving antenna
- 2) Converter
- 3) DIRD
- 4) Coupling cable between the converter and the DIRD

However, the satellite receiving antenna (including a feed horn) may be integrated with the converter.

(2) The terrestrial receiver is composed of the following units:

- 5) Terrestrial receiving antenna
- 3) DIRD
- 6) Coupling cable between the terrestrial receiving antenna and the DIRD

The basic configuration of the DIRD is shown in Fig. 2-2.

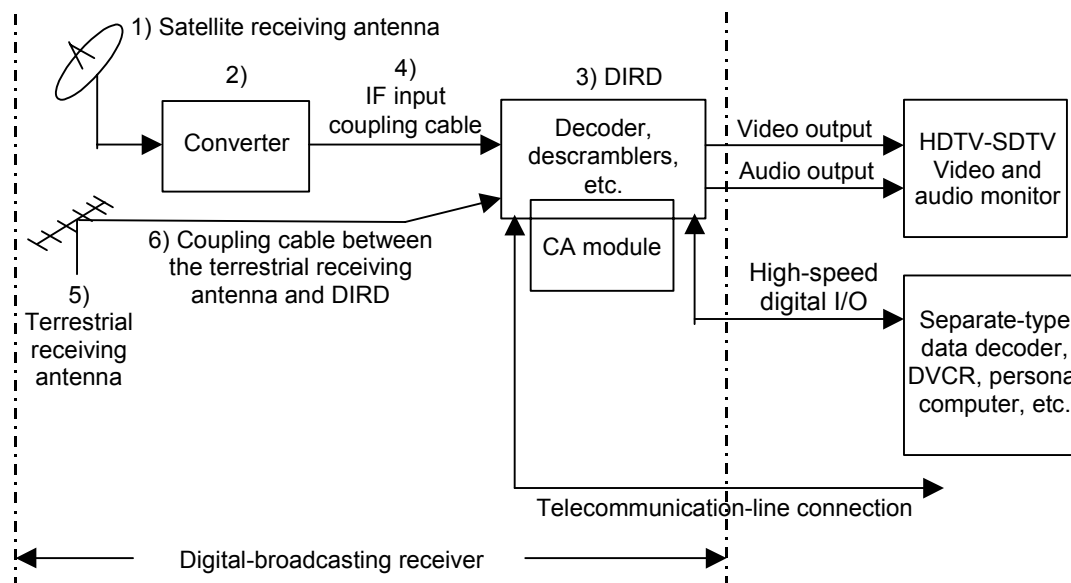

Fig. 2-1 Basic configuration of the receiver

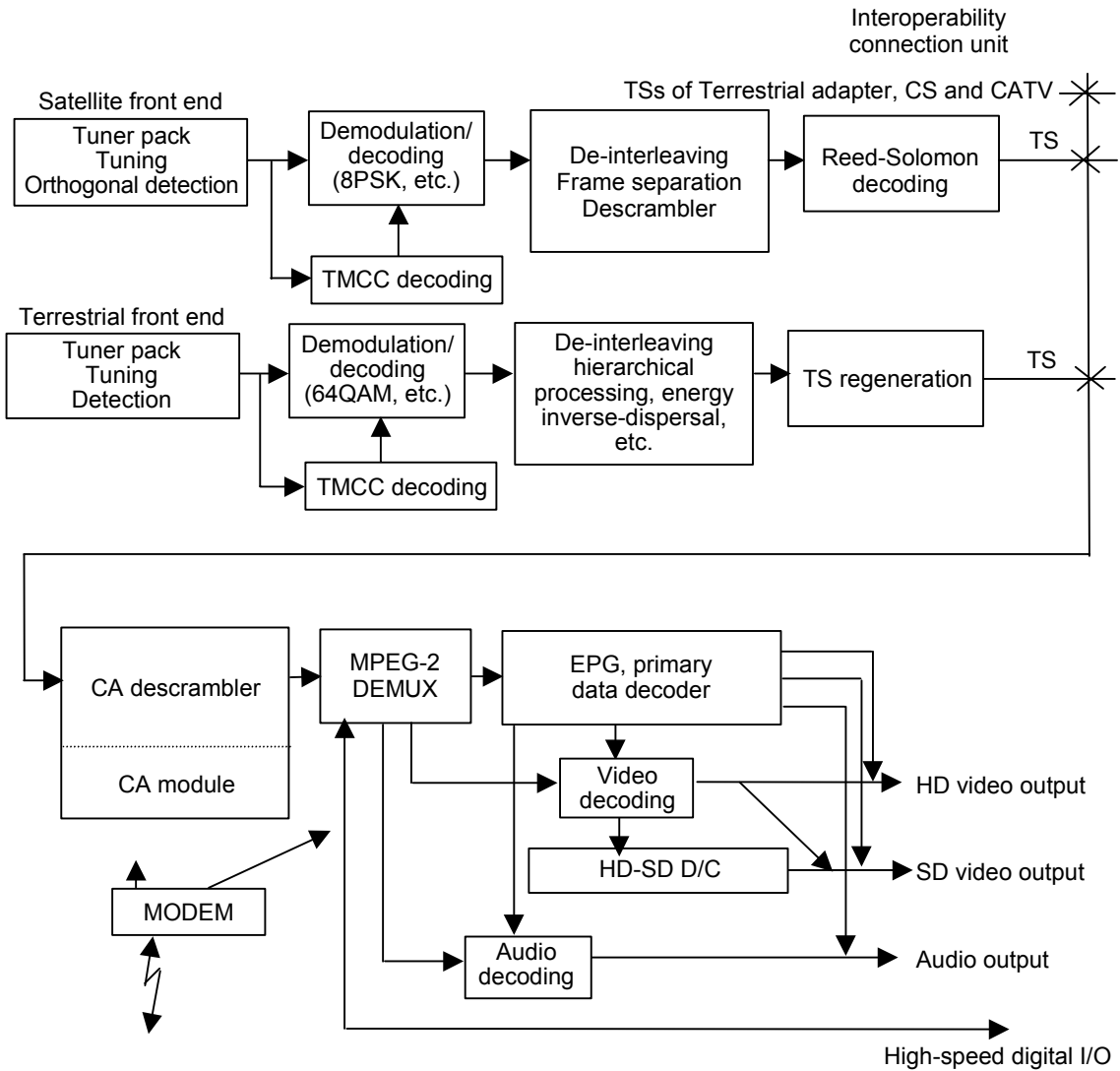

Fig. 2-2 Basic configuration of DIRD

Chapter 3: Ambient conditions

The ambient conditions must be stipulated in the following ranges unless otherwise specified.

(1) Antenna and converter

Ambient temperature: -30°C to $+50^{\circ}\text{C}$

Humidity: 20% to 90% RH

(2) DIRD

Ambient temperature: 0°C to $+40^{\circ}\text{C}$

Humidity: 30% to 90% RH

However, it is necessary for mobile-type receivers to be capable of operating in a range from -10°C to $+60^{\circ}\text{C}$ (reference value).

Chapter 4: Ratings and specifications of the units of the digital satellite broadcasting receiver

In the descriptions in this chapter, [BS] indicates the ratings and specifications only for BS digital broadcast receivers, and [BS · CS] indicates those of the BS and broadband CS digital broadcast dual-purpose receivers.

4.1 Satellite receiving antenna

Table 4-1

Item	Rating
Received frequency range	[BS] 11.71023–12.16669 GHz [BS · CS] 11.71023–12.74825 GHz
Receiving polarization	[BS] Right-hand circular [BS · CS] Right-hand/left-hand circular
Antenna diameter	The desired antenna diameter is not stipulated, as the necessary antenna diameter varies depending on the receiving conditions.
Output structure	Not applicable to the all-in-one type with a converter. However, if the receiving antenna is not integrated with the converter, the output structure must be composed of a WRJ-120-type waveguide and a BRJ-120 flange, and must be of the waterproof type.

4.2 Converter

Table 4-2

Item	Rating
Input structure	Not applicable to the all-in-one type with a receiving antenna. However, if the converter is not integrated with the receiving antenna, the input structure must be composed of the WRJ-120-type waveguide and the BRJ-120 flange, and must be provided with waterproof packing.
Range of input-signal level	For one channel: BS band: -90 to -70 dBm CS band: -94 to -70 dBm
Overall gain	BS band: 52 dB ± 4 dB CS band: 52 dB ± 6 dB
Intermediate frequency	BS band: 1032.23–1488.69 MHz CS band: 1575.75–2070.25 MHz (* See the Appendix for the single cable method of a CS left-hand circular.)
First local frequency	10.678 GHz (* See the Appendix for the single cable method of a CS left-hand circular.)
Output impedance	75 Ω
Output structure	Waterproof receptacle equivalent to a high-frequency coaxial C15-type connector
Power supply	[BS] DC +15 V +10% -12%, 4 W or less [BS · CS] Right-hand circular, DC 13.5 V to 16.5 V (15 V), 4 W or less Left-hand circular, DC 9.5 V to 12.0 V (11 V), 3 W or less

4.3 Coupling cable

Table 4-3

Item	Rating
Type	Equivalent to S-4CFB or upper grade
Cable length	The assumed maximum length is 30 m. Loss generated in the cable in conjunction with the achievement of broadband performance is compensated for by inserting a booster between the converter and DIRD.
Connection connector	Converter side: High-frequency coaxial C15-type waterproof plug DIRD side: F-type plug

4.4 Specifications of DIRD

DIRD must satisfy the following specifications.

4.4.1 IF input

- Input-terminal structure: Receptacle equivalent to a high-frequency coaxial C15-type connector
- Impedance: 75 Ω
- Received frequency: [BS] 1032–1489 MHz
[BS · CS] 1032–2071 MHz
- Input-signal level: -61 dBm to -28 dBm

4.4.2 Intermediate frequency

- Intermediate frequency: Either 402.78 MHz or 479.5 MHz; otherwise, direct conversion must be conducted. However, as the intermediate frequencies lie in the frequency band of terrestrial television UHF broadcasting, it is necessary to consider direct wave interference.

4.4.3 Bandwidth of the intermediate frequency

- The bandwidth must be within an occupied bandwidth of 34.5 MHz.

4.4.4 Second local oscillator frequency

- On the upper side of the received frequency

4.4.5 Front-end signal processing

- Channel selection: A channel must be selected from among the Ifs, in accordance with the channel-selection control signal.
- Demodulation: The modulated wave is demodulated. The necessary timings for a super frame, a frame, and a packet are generated through clock regeneration, clock distribution, and synchronization acquisition. Burst signals for carrier synchronization must be eliminated.
- Waveform shaping: Waveforms with a roll-off factor of 0.35 and a raised cosine characteristic must be distributed via a transmission/reception route. The sending side must conduct aperture compensation using $x/\sin(x)$.

- Error-correction (inner code): Trellis/Viterbi decoding must be conducted.
 - TMCC decoding: TMCC is extracted from the decoded signal and decoded.
 - Frame reconstruction: A frame structure must be reconstructed from the decoded signal.
 - Energy inverse-dispersal: The inverse-dispersal is conducted with the 15th M-sequence PN signal.
 - Error-correction (outer code): Shortened Reed-Solomon code (204,188) is decoded.
- * With respect to information transmission using phase-reference burst signals, ARIB STD B-20 stipulates that “it is possible, but will be left as a task for the future.” In the design and manufacture of the IRD, this stipulation must be considered. Even when the information transmission is to be conducted in the future, it is not necessary for the IRD to conduct the decoding.

4.4.6 Transport processing

A TS packet is selected in accordance with a TS selection signal from a TS packet stream that is frame-structured (made up of 48 slots) and is output.

It is mandatory for DIRD to have a section filtering function that supports the following three section formats for data stipulated by ISO/IEC13818-1:

- (1) One section is composed of one TS packet
- (2) Multiple sections are composed of one TS packet (However, the maximum number of sections included in one TS packet is limited to 10.)
- (3) One section is composed of two or more TS packets

4.4.7 Conditional access

This will be described in Chapter 10.

4.4.8 Memories

4.4.8.1 Memory for the contents of data broadcasting

The receiver must have volatile memory of 2 MB or more for the contents of data broadcasting.

4.4.8.2 Memory for storage of the DIRD program

The receiver must have nonvolatile memory for the storage of program codes.

4.4.8.3 Memory for storage data common to all receivers

As a nonvolatile memory area for data common to all receivers, the BS digital broadcast receiver must have memory area of 10K byte and the BS/broadband CS digital broadcast dual-purpose receivers must have memory areas of 30K byte, the terrestrial/BS/broadband CS digital-compatible receiver must have memory area of 40K byte, for a genre table, a program characteristic table, and the reserved words etc. Various common use receivers shall be able to share the memory for the genre table, the reserved word table and the like that are commonly used in all transmission media. In addition, each receiver must have a data area for the storage of logo data. In which logotype among the six types the logo data is to be stored depends on the implementation of the receiver. The required memory capacity in each logotype is shown in Table 4-4.

Table 4-4 Size of logo data

(Three hundred types of logo data and a thousand types of services are assumed for the BS and the broadband CS, respectively.)

HD large	(1/2 compression)	354 KB
HD small	(3/4 compression)	300 KB
SD4:3 large	(1/2 compression)	397 KB
SD4:3 small	(3/4 compression)	267 KB
SD16:9 large	(1/2 compression)	300 KB
SD16:9 small	(3/4 compression)	202 KB

4.4.9 Video decoding and its output

This will be described in Chapter 6.

4.4.10 Audio decoding and its output

This will be described in Chapter 6.

4.4.11 Primary data decoder

This will be described in Chapter 7.

4.4.12 EPG function

This will be described in Chapter 8.

4.4.13 High-speed digital interface

This will be described in Chapter 9.

4.4.14 CA module interface

This will be described in Chapter 10.

4.4.15 External interfaces

(1) IF input

One IF input terminal must be provided.

(2) IC-card slot

This will be described in Chapter 10.

(3) Bidirectional communication function

This will be described in Chapter 11.

(4) High-speed digital interface

One high-speed digital interface must be provided.

(5) Video output (except for the all-in-one-type receiver and monitor set)

This will be described in Chapter 6.

(6) Audio output (except for the all-in-one-type receiver and monitor set)

This will be described in Chapter 6.

4.4.16 Remote controller and channel access

No stipulations are made for the shape or keys of the remote controller, the channel access method, or the like. However, commonality of the keys used for basic functions (power supply/channel access/system setting, etc.) should be provided wherever possible, in order to increase convenience for the user.

(1) Necessary buttons

It is desirable that the following buttons be provided to enable the user to enjoy digital broadcast services:

- Power-supply button (button that the user operates to switch between full power and a waiting state)
- Ten keys, an EPG key, a decision key, channel up-and-down keys, and a menu key
- “Move upward,” “move downward,” “move rightward,” and “move leftward” (A joystick or the like may be substituted.)

For the BS and broadband CS dual-purpose receivers, it is desirable that the following button be provided in addition to the above-mentioned buttons:

- Network changeover button

(2) Channel access

The channel access method is not stipulated, but is left to those involved in product planning. However, a service ID, a channel name, and a logo are designated by the broadcast service provider. The method of accessing a channel, that is, whether it is done by entering the service ID or by operating ten keys, a channel addressing key, or the like, is left for the product planning.

Chapter 5: Ratings and specifications of the receiving units for the digital terrestrial television broadcasting

5.1 Receiving antenna

Table 5-1 Ratings of the receiving antenna

Item	Rating
Range of received frequency	UHF ch 13–62 (470–770 MHz)
Received polarized wave	Horizontal or vertical
Antenna gain	Antenna gain is not stipulated, as it varies depending on the reception conditions (Note 1).
Directional pattern	A directional pattern is not stipulated, as it varies depending on the reception conditions (Note 2).

(Note 1) It is desirable that, when the antenna is permanently installed outdoors (stationary reception), the antenna gain be equivalent to or greater than that of a 14-element Yagi antenna (7 dB/UHF ch 13).

(Note 2) It is desirable that, when the antenna is permanently installed outdoors, installation be conducted as stipulated in ITU-R recommendation 419-3 (see the drawing below).

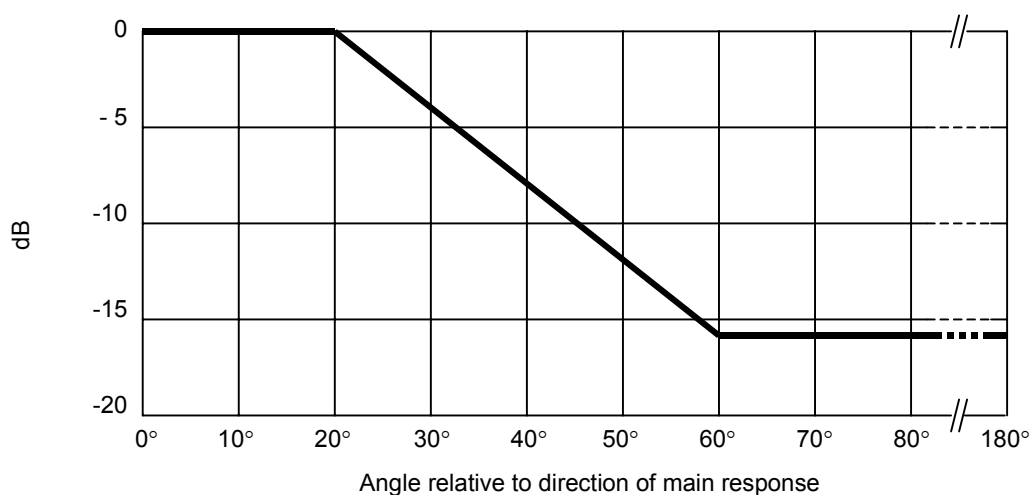

Fig. 5-1 Directional pattern of the antenna (excerpt from ITU-R recommendation 419-3)

5.2 Specifications of the DIRD

The DIRD must satisfy the following specifications.

5.2.1 Input

- Impedance: 75 Ω
- Received frequency: UHF ch 13-62
- Center frequency: 473 + 1/7 MHz (ch 13), 479 + 1/7 MHz (ch 14), . . . , and 767 + 1/7 MHz (ch 62)

With respect to a digital terrestrial television broadcasting receiver that is a stationary receiver or the like and is expected to serve as community receiving equipment, it is desirable that the reception channel range thereof include the SHB band (ch C23–C63) in addition to the UHF band. It is also desirable that the reception channel range of the receiver includes the VHF band (ch 1 to ch 12) and the MID band (ch C13 to ch C22).

See Appendix 10 for the performance of the receiver for digital terrestrial television broadcasting.

5.2.2 First intermediate frequency

- Center frequency: 57 MHz (frequency reversed)
- Local oscillator frequency: At the upper side of the received frequency

5.2.3 Synchronization range of the received frequency

- Synchronization range of the received frequency: ± 30 KHz or wider

5.2.4 Synchronization range of the received clock

- Synchronization range of the received clock: ± 20 ppm or wider

5.2.5 Characteristics of the tuning unit

A tuning unit for receiving 13 segments and a tuning unit for receiving 1 segment located in the central part of the 13 segments must satisfy the following specifications:

- Minimum input level: -75 dBm or lower (targeted value) (See Appendix 10.).
- Maximum input level: -20 dBm or higher.

However, when the input level in a one-segment receiver is measured in terms of electric power per segment, the level must be reduced by a factor equivalent to the bandwidth (i.e., one-thirteenth, or -11 dB).

Table 5-2 Protection Ratios of the 13-segment receiver

Undesired wave	Item	Protection Ratio
Analog television	From the co-channel	18 dB or less
	From the lower adjacent channel (undesired wave on the lower side)	-33 dB or less
	From the upper adjacent channel (undesired wave on the upper side)	-35 dB or less
Digital television	From the co-channel	24 dB or less
	From the lower adjacent channel (undesired wave on the lower side)	-26 dB or less
	From the upper adjacent channel (undesired wave on the upper side)	-29 dB or less

(Note) The transmission parameters used for the measurement must be as follows: Mode 3, guard interval ratio of 1/8, no time interleaving, modulation of 64 QAM, and an inner-code of 7/8 (See the Appendix.)

The one-segment receiver must satisfy the above specifications. An improvement in performance can be expected due to the fact that the segment in the center of 13-segments is allocated apart from the video and audio carriers of the analog television signal for the co-channel interference. Further, in the interference from adjacent channels, an improvement in performance can be expected due to the separation of frequency locations.

5.2.6 Front-end signal processing

(1) Signal processing in the 13-segment receiver

- Outline of a receiving block diagram

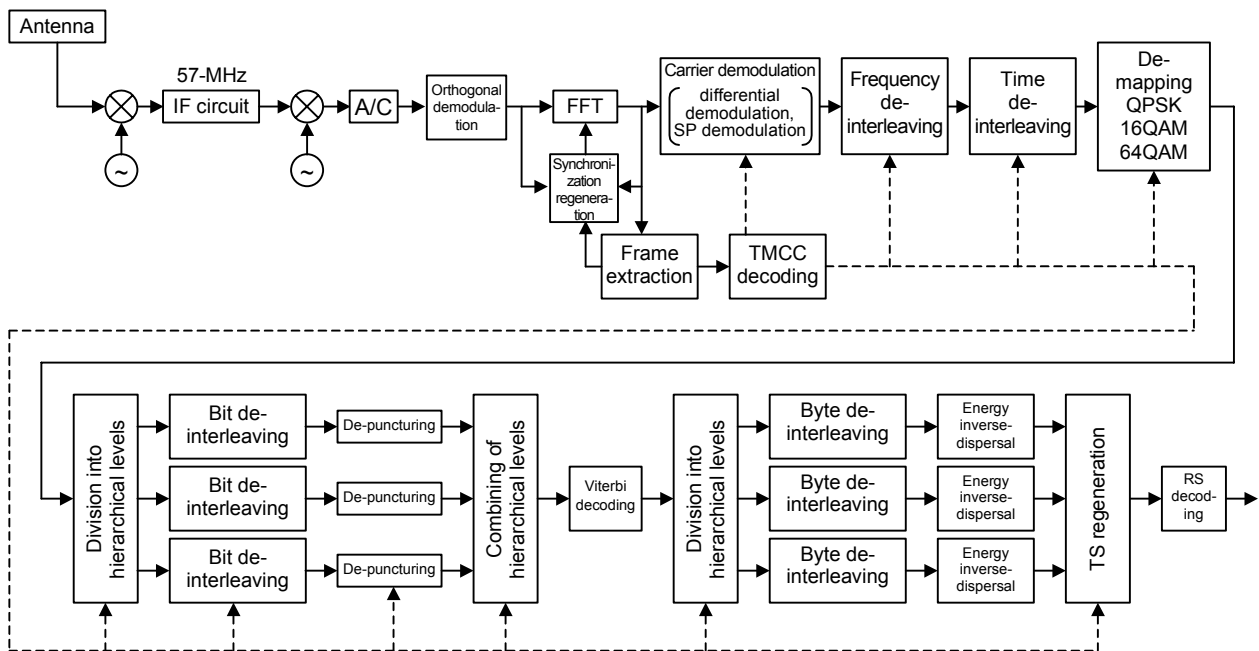

- Channel selection: A channel of UHF television broadcasting is specified.
- Synchronization regeneration: The signal in a selected channel is orthogonally demodulated and, through synchronization regeneration, OFDM symbol synchronization and an FFT sample frequency are regenerated in accordance with the Mode and the guard interval length. The Mode and the guard interval length can be judged with the correlation of the guard interval period of the OFDM signal.
- FFT: FFT operation is executed for a period corresponding to an effective OFDM symbol duration. Due to the multipath state of the received signal, FFT processing must be performed for a suitable period.
- Frame extraction: OFDM frame synchronization signal is extracted from the TMCC signal.
- TMCC decoding: TMCC information is extracted from the TMCC signal and used to conduct various controls.
- Carrier demodulation: In accordance with the TMCC information, differential demodulation for DQPSK (Differential Quadrature Phase Shift Keying), synchronous demodulation through the use of scattered pilot (SP) for QPSK (Quadrature Phase Shift Keying), 16QAM, or 64QAM is conducted, to detect amplitude and phase information.
- De-interleaving: Frequency and time de-interleaving is conducted.
- De-mapping: De-mapping of QPSK, 16QAM, or 64QAM is executed in accordance with the amplitude and phase information and bit information is extracted.

- Division into hierarchical levels: When TMCC information indicates execution of hierarchical transmission, the signal is divided into hierarchical levels. Note that the division is performed of 204 bytes between the byte next to the synchronization byte (47 H) of the TS packet and the synchronization byte of the next TS packet.
- Bit de-interleaving: Bit de-interleaving is executed in the each level of hierarchy.
- De-puncturing: Bit-interpolation is executed for the each level of hierarchy, in accordance with the convolution coding rate indicated in the TMCC information.
- Viterbi decoding: Viterbi decoding with a coding rate of 1/2 is executed. In Viterbi decoding, a soft-decision algorithm is employed to improve performance. Further, to avoid error propagation due to the convolutional code, termination processing is conducted based on the fact that the synchronization byte (47 H) of the TS packet is already known.
- Byte de-interleaving: De-interleaving is executed on a byte-by-byte basis.
- Energy inverse-dispersal: Inverse dispersal is conducted by means of exclusive ORing with the 15th M-sequence PN signal on a bit-by-bit basis, except for the synchronization byte of the TS packet. Note that during the period of the synchronization byte, a shift register is in operation, and initialized at every OFDM frame.
- TS regeneration: Processing for regeneration of a transport stream is conducted. On this occasion, the order of the TS packets and the temporal location of the PCR should be the same as they are on the transmitting side.
- RS decoding: Shortened Reed-Solomon code RS(204,188) is decoded. During RS decoding, if an error is detected following a correction, transport_error_indicator, which is positioned at the 9th bit of the transport stream packet (specifically, MSB in the second byte), is set to “1.”

(2) Signal processing in the one-segment receiver

In digital terrestrial television broadcasting, only one segment in the central part (segment index of 0) of the 13 segments can be transmitted as a hierarchical level of partial-reception. Such a signal can be received by the 13-segment receiver described in (1). In order to reduce power consumption, only one segment can be received by reducing the order of FFT with the lower clock rate.

- Outline of a receiving block diagram

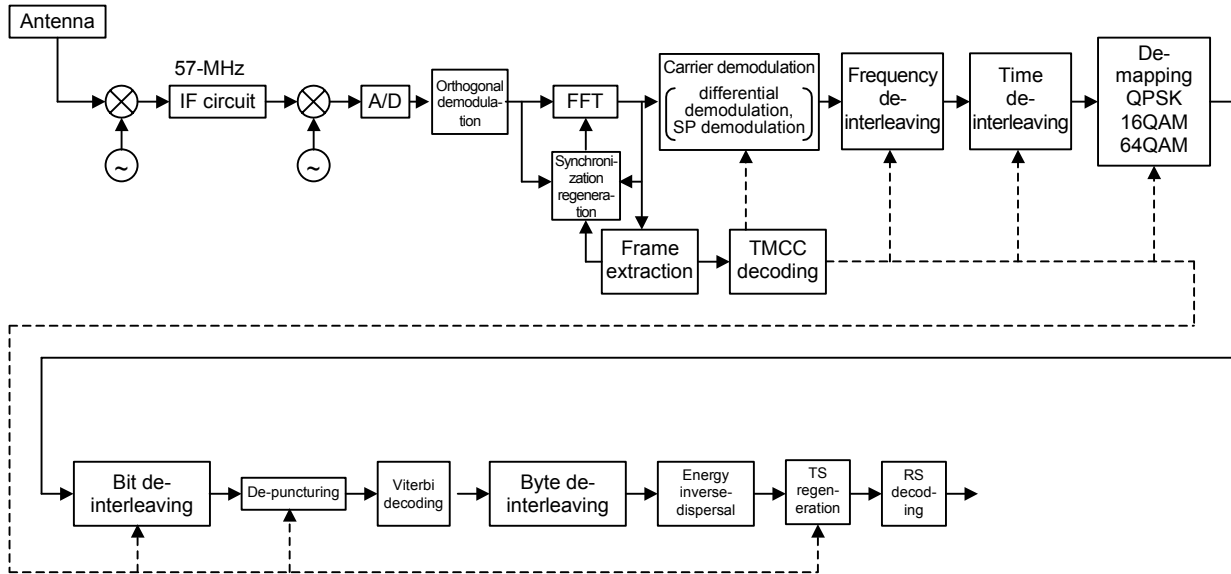

- Channel selection: A channel of UHF television broadcasting is specified. As the partially received segment is always selected at the center of the 13 segments, it can be selected by channel designation as in (1).
- Synchronization regeneration: As in (1)
- FFT: As in (1)
Note that it is preferable to set the number of FFT size as 256 points (Mode 1), 512 points (Mode 2), or 1024 points (Mode 3).
- Frame extraction: As in (1)
- TMCC decoding: As in (1)
- Carrier demodulation: As in (1)
Note that, as there is only one level in the hierarchy in the case of one-segment reception, it is not necessary to demodulate simultaneously for plural levels described in the 13-segment receiver.
- De-interleaving: As in (1)
- De-mapping: As in (1)
- Bit de-interleaving: As in (1)
- De-puncturing: As in (1)
- Viterbi decoding: As in (1)
- Byte de-interleaving: As in (1)
- Energy inverse-dispersal: As in (1)
- TS regeneration: As in (1)
- RS decoding: As in (1)

5.2.7 Transport processing

It is mandatory that the DIRD has a section filtering function to support the following three types of section formats for data stipulated in ISO/IEC13818-1:

- (1) Each section composed of one TS packet
- (2) Multiple sections composed of one TS packet (However, the maximum number of sections included in one TS packet is limited to 10).
- (3) Each section composed of two or more TS packets

5.2.8 Conditional access

This will be described in Chapter 10.

5.2.9 Memories

5.2.9.1 Memory for contents of the data broadcasting

The receiver must have volatile memory of 2 MB or more for contents of the data broadcasting.

5.2.9.2 Memory for storing DIRD programs

The receiver must have nonvolatile memory for storing the program codes.

5.2.9.3 Memory for storing data common to all receivers

As a nonvolatile memory area for data common to all receivers, the terrestrial broadcast receiver must contain 10K byte of storage area and the terrestrial/BS/broadband CS-compatible receiver must have 40K byte of storage area, for the genre table, the program characteristic table, reserved words, and the like. The common use receivers shall be able to share the memory for the genre table, the reserved word table and the like that are commonly used in all transmission media. Which of the six types of logo data the logotype is to be stored depends on the implementation of the receiver. The required memory capacity for each logotype is shown in Table 5-3. For dual-purpose receivers for satellite and terrestrial broadcasting, the required memory capacity will be increased by the value shown in Table 4-4 in the previous chapter.

Furthermore, storage area of the frequency list and change information should be secured. For operation, refer to Appendix 3 of this document and “Digital terrestrial television broadcasting operational procedure” in the ARIB technical documents.

Table 5-3 Size of logo data
(180 logo types and the 480 services
of digital terrestrial television broadcasting)

HD Large	(1/2 compression)	211 KB
HD small	(3/4 compression)	179 KB
SD4:3 Large	(1/2 compression)	237 KB
SD4:3 small	(3/4 compression)	159 KB
SD16:9 Large	(1/2 compression)	179 KB
SD16:9 small	(3/4 compression)	120 KB

5.2.10 Video decoding and its output

This will be described in Chapter 6.

5.2.11 Audio decoding and its output

This will be described in Chapter 6.

5.2.12 Primary data decoder

This will be described in Chapter 7.

5.2.13 EPG function

This will be described in Chapter 8.

5.2.14 High-speed digital interface

This will be described in Chapter 9.

5.2.15 CA module interface

This will be described in Chapter 10.

5.2.16 External interfaces

(1) Antenna input

One antenna input terminal must be provided.

(2) IC-card slot

This will be described in Chapter 10.

(3) Interactive communication function

This will be described in Chapter 11.

(4) High-speed digital interface

One high-speed digital interface must be provided (this stipulation does not apply to all-in-one-type digital receivers integrated with a monitor apparatus).

(5) Video output (except for all-in-one-type digital receivers integrated with a monitor apparatus)

This will be described in Chapter 6.

(6) Audio output (except for all-in-one-type digital receivers integrated with a monitor apparatus)

This will be described in Chapter 6.

5.2.17 Remote controller and channel access

No stipulations are made for the shape of the remote controller, the keys, the channel access method, or the like. However, commonality of the keys used for basic functions (power supply/channel access/system setting, etc.) should be provided wherever possible, in order to increase convenience for the user.

(1) Necessary buttons

It is desirable that the following buttons be provided to enable the user to enjoy digital broadcast services:

- Power-supply button (button that the user operates to switch between full power and a waiting state)
- Ten keys, an EPG key, a decision key, channel up-and-down keys, and a menu key
- “Move upward,” “move downward,” “move rightward,” and “move leftward” (A joystick or the like may be substituted.)

It is desirable that the following button be provided in addition to the above-mentioned buttons for the receiver that can also receive Digital Sattellite Broadcasting:

- Network changeover button

(2) Channel access

The channel access method is not stipulated, but is left to those involved in product planning. However, a service ID, a channel name, and a logo are designated by the broadcast service provider. The method of accessing a channel, that is, whether it is done by entering the service ID or by operating ten keys, a channel addressing key, or the like, is left to those involved in product planning.

5.3 Analog broadcast receiving function

It is assumed that, for terrestrial television broadcasting, a period of approximately eight years will be required from the introduction of digitalization until its completion. There may be cases in which a viewer having purchased the digital receiver will move to an area in which digitalization has not yet been introduced. It is therefore desirable that the set-top-box-type digital receivers and the all-in-one-type digital receiver integrated with a monitor apparatus, to be introduced on the market prior to the completion of digitalization, have a receiving function for analog broadcasting.

Chapter 6: Decoding process of video and audio and output signals

6.1 Video decoding process and output signals

6.1.1 Video decoding process

The receiver should be capable of decoding an MPEG-2 (ISO/IEC13818-2) stream that complies with the constrained coding parameters given in Table 6-1 (a case in which the display-screen area is not specified by `sequence_display_extension`) and Table 6-2 (a case in which the display-screen area is specified by `sequence_display_extension`). Timing of video and audio decoding and output should be controlled by the PTS and DTS in PES header, and the control of decoding using `vbv_delay` not be conducted. Table 6-3 shows the meanings of the code indexes of the MPEG-2 coding parameters in Tables 6-1 and 6-2. The positions of active lines of the video signal are as shown in Table 6-4.

Table 6-3 Meaning of the code index of the MPEG-2 coding parameters in Tables 6-1 and 6-2

<code>aspect_ratio_information</code>	2 = 4:3 display 3 = 16:9 display
<code>frame_rate_code</code>	4 = 30/1.001 Hz 7 = 60/1.001 Hz
<code>progressive_sequence</code>	0 = Interlaced scanning scheme 1 = Progressive scanning scheme
<code>color_primaries</code>	1 = Rec. ITU-R BT.709 (BT.1361)
<code>transfer_characteristics</code>	1 = Rec. ITU-R recommendation BT.709 (BT.1361)
<code>matrix_coefficients</code>	1 = Rec. ITU-R BT.709 (BT.1361)

Table 6-4 Positions of active lines

Video output-signal format	Number of lines to be decoded	Active lines
525i	480	Lines 23–262 and lines 286–525
525p	480	Lines 45–524
750p	720	Lines 26–745
1125i	1080	Lines 21–560 and lines 584–1123

Table 6-1 Constrains of coding parameters 1 (case in which the display screen area is not specified by sequence_display_extension)

Constrains of sequence_header				Constrains of sequence_extension	Constrains conditions of sequence_display_extension (Note 4)			Other parameters (Note 6)
vertical_size_value	horizontal_size_value	aspect_ratio_information	frame_rate_code	progressive_sequence	color_primaries	transfer_characteristics	matrix_coefficients	
1080 (Note 1)	1920, 1440	3	4 (Note 3)	0	1 (Note 5)	1 (Note 5)	1 (Note 5)	Value specified for MP@HL
720	1280	3	7 (Note 3)	1				Value specified for MP@H14L
480	720	3	7 (Note 3)	1				Value specified for MP@HL
480	720, 544, 480 (Note 2)	3 2	4 (Note 3)	0				Value specified for MP@HL

(Note 1) In MPEG-2 coding (ITU-T H.262), 1088 lines are coded actually. Eight lines of fictional video data (dummy data) are added under the valid lines by the encoder, and coding process is made as video data of 1088 lines actually. Video signal with 1080 lines of valid line excluding dummy data, which is 1080th lines from the top of the 1088 lines of video data is output at the decoder.

(Note 2) When horizontal_size_value is 544 samples, center position is adjusted with 720 samples and constructed of 544 samples adding 2 samples of fictional video data (black base) on the both sides of the actual video data 540 samples.

(Note 3) In case of film material, encoding by controlling flags of repeat_first_field, top_field_first, and progressive_frame without changing frame_rate_code is also enabled.

(Note 4) When sequence_display_extension is not transmitted, the receiver should process assuming that the values of display_vertical_size and display_horizontal_size are equal to those of vertical_size_value and horizontal_size_value in sequence_header. However, when horizontal_size_value is 544 samples, a region of 540 samples, which is formed by eliminating 2 samples from both sides of the 544 samples, is displayed in the same manner as when display_horizontal_size is transmitted as 540 samples.

(Note 5) When sequence_display_extension is not transmitted, the receiver should process assuming that the values of color_primaries, transfer_characteristics, and matrix_coefficients are each equal to "1."

(Note 6) A value specified in ITU-T H.262(ISO/IEC13818-2) is adapted to each level of Main Profile. Bit_rate_value should be not more than the maximum transmittable capacity in the BS digital broadcasting for MP@HL and MP@H14L, and 15 Mbps or less for MP@ML. It is operated on a variable bit rate basis, and vbv_delay should always be set to 0xFFFF.

Table 6-2 Constrains of coding parameters 2 (case in which the display-screen area is specified by sequence_display_extension)

Constrains of sequence_header				Constrains of sequence_extension	Constrains of sequence_display_extension					Other parameters (Note 7)	
vertical_size_value	horizontal_size_value	aspect_ratio_information (Note 3)	frame_rate_code (Note 4)	progressive_sequence	display_vertical_size	display_horizontal_size (Note 5)	color_primaries	transfer_characteristics	matrix_coefficients		
1080 (Note 1)	1920, 1440	3	4	0	1080	1920, 1440	1 (Note 6)	1 (Note 6)	1 (Note 6)	Value specified for MP@HL	
	1920					1440					
	1440					1080					
720	1280	3	7	1	720	1280	1 (Note 6)	1 (Note 6)	1 (Note 6)		Value specified for MP@H14L
		2				960					
480	720	3	7	1	480	720					
		2				540					
480	720, 544, 480 (Note 2)	3	4	0	480	720, 540, 480	1 (Note 6)	1 (Note 6)	1 (Note 6)	Value specified for MP@ML	
	720	540									
	720, 544, 480 (Note 2)	2			360	720, 540, 480					
		3									

(Note 1) In MPEG-2 coding (ITU-T H.262), 1088 lines are coded actually. Eight lines of fictional video data (dummy data) are added under the valid lines by the encoder, and coding process is made as image data of 1088 lines actually. Video signal with 1080 lines of valid line excluding dummy data, which is 1080th lines from the top of the 1088 lines of valid data is output at the decoder.

(Note 2) When horizontal_size_value is 544 samples, center position is adjusted with 720 samples and constructed of 544 samples adding 2 samples of fictional video data (black base) on the both sides of the actual video data 540 samples.

(Note 3) When sequence_display_extension is transmitted, aspect_ratio_information indicates the aspect ratio of a region specified by display_vertical_size and display_horizontal_size, which is specified in the MPEG-2 standard.

(Note 4) In case of a film material, encoding by controlling flags of repeat_first_field, top_field_first, and progressive_frame without changing frame_rate_code is also enabled.

(Note 5) When there are multiple numbers in one field of display_horizontal_size, the same numbers as those of horizontal_size_value can be selected (however, when horizontal_size_value is 544, only 540 can be selected).

(Note 6) When neither color_primaries, transfer_characteristics, nor matrix_coefficients in the sequence_display_extension is transmitted, the receiver should process assuming that each value is equal to “1.”

(Note 7) A value specified in ITU-T H.262(ISO/IEC13818-2) is adapted to each level of Main Profile. Bit_rate_value should be not more than the maximum transmittable capacity in BS digital broadcasting in MP@HL and MP@H14L, and 15 Mbps or less for MP@ML. It is operated on a variable bit rate basis, and vbv_delay should always be set to 0xFFFF.

6.1.2 Video output signals

(1) Video output for display

The receiver should output the video signal for display in one or more formats selected from among 1125i, 750p, 525p, and 525i signals, regardless of the settings of the video coding parameter values of a stream to be decoded.

The receiver should have a function for changing the video-signal format in accordance with the video-signal formats that can be handled by a display to be connected in a switchable manner. When the format is 525i, the receiver should have a further function for changing the aspect ratio in accordance with the aspect ratio (4:3 or 16:9) of the display to be connected.

The relationship between the parameter values of `sequence_display_extension` of the stream and the video-signal output should be specified for Table 6-5 for the 525i signal, in Table 6-6 for the 1125i or 525p signal, in Table 6-7 for the 750p signal. However, this regulation shall not apply to cases in which the data broadcasting and EPG are displayed.

(2) Video output for recording

The receiver should output the NTSC video signal (composite video signal and Y/C video signal) as a video signal for recording simultaneously with the output of the video signal for display. It is preferred that the video output for recording be underwent the processing shown in Table 6-5, in accordance with the parameter values of `sequence_display_extension` of the stream and the aspect ratio (4:3 or 16:9) of the display. Note that the data broadcasting and the EPG need not be included in the video output for recording.

Table 6-5 Relationship between the parameter values of sequence_display_extension of a stream and video-signal output 1

Reference drawing	Parameter values of sequence_header			Parameter values of sequence_extension	Parameter values of sequence_display_extension		Output video signal in 525i format to a 4:3 monitor (720 pixels horizontally)			Output video signal in 525i format to a 16:9 monitor (720 pixels horizontally)		
	vertical_size_value (A)	horizontal_size_value (B)	aspect_ratio_information	progressive_sequence	display_vertical_size (C)	display_horizontal_size (D)	Vertical scaling ratio (L: line)	Horizontal scaling ratio	Re-mark	Vertical scaling ratio	Horizontal scaling ratio (S: sample)	Re-mark
1)	1080	1920	3	0	1080	1920	A x (1/3) + 120L black	B x (3/8)	1	A x (4/9)	B x (3/8)	2
		1440				B x (1/2)		B x (1/2)				
	720	1280	3	1	720	1280	A x (1/2) + 120L black	B x (9/16)		A x (2/3)	B x (9/16)	
	480	720	3	1	480	720	A x (3/4) + 120L black	B x 1		A x 1	B x 1	
	480	720	3	0	480	720	A x (3/4) + 120L black	B x 1		A x 1	B x 1	
		544				D x (4/3)		D x (4/3)				
480	480				480		B x (3/2)		B x (3/2)			
2)	1080	1920	2	0	1080	1440	A x (4/9)	D x (1/2)	3	A x (4/9)	B x (3/8)	4
		1440				1080		D x (2/3)			B x (1/2)	
	720	1280	2	1	720	960	A x (2/3)	D x (3/4)		A x (2/3)	B x (9/16)	
	480	720	2	1	480	540	A x 1	D x (4/3)		A x 1	B x 1	
	480	720	2	0	480	540	A x 1	D x (4/3)		A x 1	B x 1	
3)	480	720	2	0	480	720	A x 1	B x 1	5	A x 1	B x (3/4) + 180S black or B x 1	6
		544				540		D x (4/3)			D x 1 + 180S black or D x (4/3)	
		480				480		B x (3/2)			B x (9/8) + 180S black or B x (3/2)	
4)	480	720	3	0	360	720	A x 1	B x 1	7	C x (4/3) or A x 1	B x 1	8
		544				540		D x (4/3)			D x (4/3)	
		480				480		B x (3/2)			B x (3/2)	

- Note 1: When sequence_display_extension exists, aspect ratio information represents the aspect ratio of the region specified by display_vertical_size(C) and display_horizontal_size(D), which is defined in the MPEG standard.
- Note 2: When sequence_display_extension is not transmitted, the receiver should process assuming that the values of display_vertical_size(C) and display_horizontal_size(D) are equal to those of vertical_size_value(A) and horizontal_size_value(B) in sequence_header. However, when B is 544, signal should be processed so that 540 samples obtained by removing two samples from each side of the 544 samples are displayed in the same manner as when D is 540. When D happens to be transmitted as 544, the receiver should conduct the processing in the same manner as when D is not transmitted.
- Note 3: The functions of the receiver may be limited based on the assumption that processing is conducted with frame_center_horizontal_offset(FCHO) and frame_center_vertical_offset(FCVO) in picture_display_extension normally being zero. When picture_display_extension is not transmitted, FCHO and FCVO are interpreted as zero.
- Note 4: The scaling ratio of the 4:3 monitor stipulated here shall not apply to S1 (type with a 4:3 monitor with a vertical deflection amplitude that can be altered)-compliant apparatuses.
- Note 5: See Fig. 6-1 as a reference drawing.

Table 6-6 Relationship between the parameter values of sequence_display_extension of a stream and the video signal output 2

Reference drawing	Parameter values of the sequence_header			Parameter values of the sequence_extension	Parameter values of the sequence_display_extension		Output video signal in 1125i format to a 16:9 monitor (1920 pixels horizontally)			Output video signal in 525p format to a 16:9 monitor (720 pixels horizontally)			
	vertical_size_value (A)	horizontal_size_value (B)	aspect_ratio_information	progressive_sequence	display_vertical_size (C)	display_horizontal_size (D)	Vertical scaling ratio	Horizontal scaling ratio (S: sample)	Re-mark	Vertical scaling ratio	Horizontal scaling ratio (S: sample)	Re-mark	
1)	1080	1920	3	0	1080	1920	A x 1	B x 1	9	A x (4/9)	B x (3/8)	9	
		1440				B x (4/3)		B x (1/2)					
	720	1280	3	1	720	1280	A x (3/2)	B x (3/2)		A x (2/3)	B x (9/16)		
	480	720	3	1	480	720	A x (9/4)	B x (8/3)		A x 1	B x 1		
	480	720	3	0	480	720	A x (9/4)	B x (8/3)		A x 1	D x (4/3)		B x (3/2)
		544				540							
480		480											
2)	1080	1920	2	0	1080	1440	A x 1	B x 1	10	A x (4/9)	B x (3/8)	10	
		1440				1080		B x (4/3)			B x (1/2)		
	720	1280	2	1	720	960	A x (3/2)	B x (3/2)		A x (2/3)	B x (9/16)		
	480	720	2	1	480	540	A x (9/4)	B x (8/3)		A x 1	B x 1		
	480	720	2	0	480	540	A x (9/4)	B x (8/3)		A x 1	B x 1		
3)	480	720	2	0	480	720	A x (9/4)	B x 2 + 480S black	11	A x 1	B x (3/4) + 180S black	11	
		544				540		D x (8/3) + 480S black			D x 1 + 180S black		
		480				480		B x 3 + 480S black			B x (9/8) + 180S black		
4)	480	720	3	0	360	720	C x 3	B x (8/3)	12	C x (4/3)	B x 1	12	
		544				540		D x (32/9)			D x (4/3)		
		480				480		B x 4			B x (3/2)		

Note 1: When sequence_display_extension exists, aspect_ratio_information represents the aspect ratio of the region specified by display_vertical_size(C) and display_horizontal_size(D), which is defined in the MPEG standard.

Note 2: When sequence_display_extension is not transmitted, the receiver should process assuming that the values of display_vertical_size(C) and display_horizontal_size(D) are equal to those of vertical_size_value(A) and horizontal_size_value(B) in sequence_header. However, when B is 544, signal should be processed so that 540 samples obtained by removing two samples from each side of the 544 samples are displayed in the same manner as when D is 540. When D happens to be transmitted as 544, the receiver should conduct the processing in the same manner as when D is not transmitted.

Note 3: The functions of the receiver may be limited based on the assumption that processing is conducted using frame_center_horizontal_offset(FCHO) and frame_center_vertical_offset(FCVO) in picture_display_extention is normally zero. When picture_display_extension is not transmitted, FCHO and FCVO should be interpreted as zero.

Note 4: See Fig. 6-1 as a reference drawing.

Table 6-7 Relationship between the parameter values of sequence_display_extension of a stream and video signal output 3

Reference drawing	Parameter values of sequence_header			Parameter values of sequence_extension	Parameter values of sequence_display_extension		Output video signal in 750p format to a 16:9 monitor (1280 pixels horizontally)		
	vertical_size_value(A)	horizontal_size_value(B)	aspect_ratio_information	progressive_sequence	display_vertical_size(C)	display_horizontal_size(D)	Vertical scaling ratio	Horizontal scaling ratio (S: sample)	Remark
1)	1080	1920	3	0	1080	1920	A x (2/3)	B x (2/3)	9
		1440				1440		B x (8/9)	
	720	1280	3	1	720	1280	A x 1	B x 1	
	480	720	3	1	480	720	A x (3/2)	B x (16/9)	
	480	720	3	0	480	720	A x (3/2)	B x (16/9)	
		544				D x (64/27)			
480		B x (8/3)							
2)	1080	1920	2	0	1080	1440	A x (2/3)	B x (2/3)	10
		1440				1080		B x (8/9)	
	720	1280	2	1	720	960	A x 1	B x 1	
	480	720	2	1	480	540	A x (3/2)	B x (16/9)	
	480	720	2	0	480	540	A x (3/2)	B x (16/9)	
3)	480	720	2	0	480	720	A x (3/2)	B x (4/3) + 320S black	11
		544				D x (16/9) + 320S black			
		480				B x 2 + 320S black			
		480							
4)	480	720	3	0	360	720	C x 2	B x (16/9)	12
		544				D x (64/27)			
		480				B x (8/3)			

Note 1: When sequence_display_extension exists, aspect_ratio_information must represent the aspect ratio of the area specified by display_vertical_size(C) and display_horizontal_size(D), which is defined in the MPEG standard

Note 2: When sequence_display_extension is not transmitted, the receiver should process assuming that the values of display_vertical_size(C) and display_horizontal_size(D) are equal to those of vertical_size_value(A) and horizontal_size_value(B) in sequence_header. However, when B is 544, signal should be processed so that 540 samples obtained by removing two samples from each side of the 544 samples are displayed in the same manner as when D is 540. When D happens to be transmitted as 544, the receiver must conduct the processing in the same manner as when D is not transmitted.

Note 3: The functions of the receiver may be limited based on the assumption that the processing is conducted using frame_center_horizontal_offset(FCHO) and frame_center_vertical_offset(FCVO) in picture_display_extention is normally zero. When picture_display_extension is not transmitted, FCHO and FCVO should be interpreted as zero.

Note 4: See Fig. 6-1 as a reference drawing.

Meaning of the code index of the MPEG-2 coding parameters given in Tables 6-5, 6-6, and 6-7	
aspect_ratio_information	2 = 4:3 display, 3 = 16:9 display
progressive_sequence	0 = interlaced scanning scheme, 1 = progressive scanning scheme

[Remarks]

1. An image transmitted in the squeeze format is displayed in a letterbox format on a 4:3 monitor. In the vertical direction, A x scaling ratio = 360, and 120 lines of black (zero signal) are added (see Fig. 6-1 #1).
2. An image transmitted in the squeeze format is displayed in full-screen mode on a 16:9 525i monitor (see Fig. 6-1 #1).
3. An image, 720 effective samples, is generated from the image data in a region specified by D, and is displayed in full-screen mode on a 4:3 monitor (see Fig. 6-1 #2).
4. An image transmitted in the squeeze format is displayed on a 16:9 525i monitor. In the case of a fake 16:9 video made up of a transmitted active image in a 4:3 aspect ratio with black regions attached to both sides thereof, 720 valid samples consist of [90 black level samples] + [540 active samples] + [90 black level samples] (see Fig. 6-1 #2).
5. An image transmitted in a 4:3 aspect ratio is displayed in full-screen mode on a 4:3 monitor (see Fig. 6-1 #3).
6. An image transmitted in a 4:3 aspect ratio is displayed on a 16:9 525i monitor. Video data is displayed using signals in the squeeze format that consist of [90 black level samples] + [540 active samples] + [190 black level samples], making B(D) x scaling ratio = 540; and level video data can be displayed using signals in the same format as that for the 4:3 monitor by means of the deflection system of the monitor side (see Fig. 6-1 #3).
7. An image transmitted in the letterbox format is displayed in the letterbox format on the 4:3 monitor (see Fig. 6-1 #4).
8. An image transmitted in the letterbox format, which contains the 16:9 active image with 360 valid lines is converted into a squeeze format with 480 valid lines and displayed in full-screen mode on the 16:9 monitor using a signal in the squeeze format; and the representation can be performed using a signal in the same format as that of the 4:3 monitor by means of the deflection system on the monitor side (see Fig. 6-1 #4).
9. An image transmitted in the squeeze format is displayed in a full-screen format on a 16:9 monitor of 1125i, 525p, or 750p (see Fig. 6-1 #1).
10. An image transmitted in the squeeze format is displayed on a 16:9 monitor of 1125i, 525p, or 750p. In cases in which the transmitted video is fake 16:9 video made up of the active image part with an aspect ratio of 4:3 and black regions attached to both sides thereof, the valid 1920 samples of the 1125i signal consist of [240 black level samples] + [1440 active samples] + [240 black level samples]. Similarly, the 720 valid samples of the 525p signal consist of [90 black level samples] + [540 active samples] + [90 black level samples], and the 1280 valid samples of the 750p signal consist of [160 black level samples] + [960 active samples] + [160 black level samples] (see Fig. 6-1 #2).
11. An image transmitted in a 4:3 aspect ratio is displayed on a 16:9 monitor of 1125i, 525p, or 750p. The 1920 valid samples of the 1125i signal consist of [240 black level samples] + [1440 active samples] + [240 black level samples], the 720 valid samples of the 525p signal consist of [90 black level samples] + [540 active samples] + [90 black level samples], and the 1280 valid samples of the 750p signal consist of [160 black level samples] + [960 active samples] + [160 black level samples], each of which is a signal in the squeeze format and is input into the 16:9 monitor (see Fig. 6-1 #3).
12. An image transmitted in the letterbox format, which contains the 16:9 active image with 360 effective lines is converted into a signal in the squeeze format with 1080 valid lines (in the case of 1125i signals), 480 valid lines (in the case of 525p signals), or 720 valid lines (in the case of 750p signals), and is displayed in full-screen mode on a 16:9 monitor of 1125i, 525p, or 750p (see Fig. 6-1 #4).

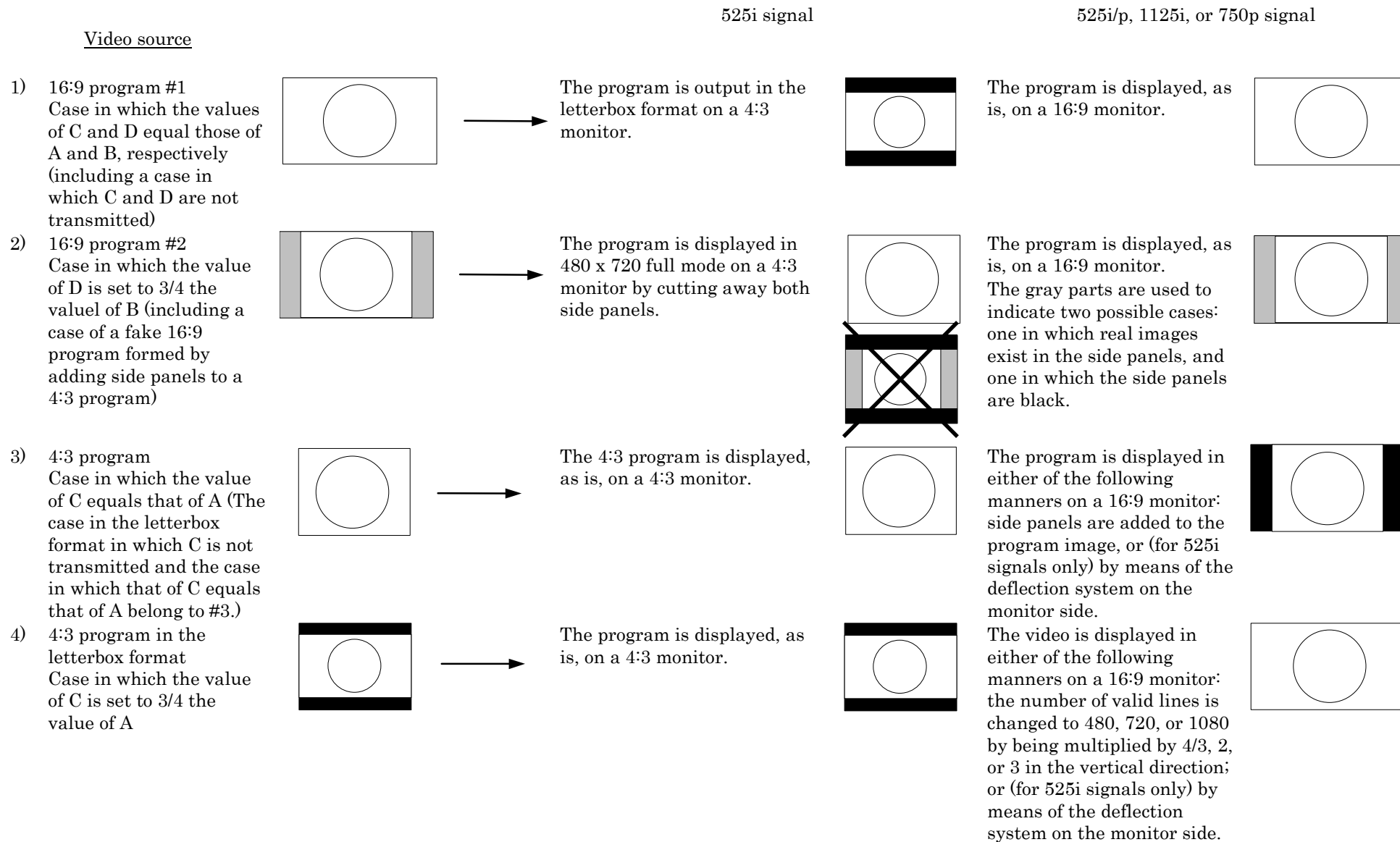

Fig. 6-1 Desirable representation formats on monitors with a 4:3 aspect ratio and a 16:9 aspect ratio

6.1.3 Video-signal output

6.1.3.1 Analog output

The receiver should be equipped with at least one video output terminal. In cases in which the receiver is equipped with an output terminal for the component signals (Y, P_B, P_R), it is preferred that at least one D terminal be provided (which is optional for the all-in-one-type receiver). Digital broadcasting receivers equipped with a D terminal should conform to the following standard of the Japan Electronics and Information Technology Industries Association (the former Electronic Industries Association of Japan; EIAJ).

JEITA standard: EIAJ CP-4120

“Interface between a Digital Tuner and Television Receiver using D-Connector”

JEITA standard: EIAJ RC-5237

“D Connector for Digital Broadcasting Component Video Signal (Y, P_B, P_R) connection”

The assumed formats of the output signal are given in the following tables.

(1) 1080i component output

Signal format	Luminance (Y)/color difference signal	Red/green/blue signal
Output level	Y: +700 mV P _B , P _R : ±350 mV Sync signal: ±300 mV, superposed on Y	700 mV _{p-p} Sync signal (VD, HD): -300 mV, not superposed on G, B, or R
Colorimetry parameter	See Table 6-8.	
Impedance	75 Ω	75 Ω
Connector	The use of D terminal is desirable.	RCA pin x 3 Sync-signal pin x 2

(2) 720p component output

Signal format	Luminance (Y)/color difference signal	Red/green/blue signal
Output level	Y: +700 mV P _B , P _R : ±350 mV Sync signal: ±300 mV, superposed on Y	700 mV _{p-p} Sync signal (VD, HD): -300 mV, not superposed on G, B, or R
Colorimetry parameter	See Table 6-8.	
Impedance	75 Ω	75 Ω
Connector	The use of D terminal is desirable.	RCA pin x 3 Sync-signal pin x 2

(3) 480p component output

Signal format	Luminance (Y)/color difference signal	Red/green/blue signal
Output level	Y: +700 mV P _B , P _R : ±350 mV Sync signal: ±300 mV, superposed on Y	700 mV _{p-p} Sync signal (VD, HD): -300 mV, not superposed on G, B, or R
Colorimetry parameter	See Table 6-8.	
Impedance	75 Ω	75 Ω
Connector	The use of D terminal is desirable.	RCA pin x 3 Sync-signal pin x 2

(4) 480i component output

Signal format	Luminance (Y)/color difference signal	Red/green/blue signal
Output level	Y: +700 mV PB, PR: ±350 mV Sync signal: -300 mV, superposed on Y	700 mV _{p-p} Sync signal (VD, HD): -300 mV, not superposed on G, B, or R
Colorimetry parameter	See Table 6-8.	
Impedance	75 Ω	75 Ω
Connector	The use of D terminal is desirable.	RCA pin x 3 Sync-signal pin x 2

(5) NTSC composite output

Signal format	NTSC composite signal
Output level	1.0 V _{p-p} , positive polarity
Impedance	75 Ω
Connector	RCA pin

(6) NTSC Y/C (S video) output

Signal format	NTSC Y/C signal
Output level	Luminance signal: 1.0 V _{p-p} Burst signal: 286 mV _{p-p}
Impedance	75 Ω
Connector	S video terminal (mini DIN 4-pin)

Table 6-8 Colorimetry parameters

Item	480i, 480p	1080i, 720p																								
Primary-color chromaticity	The CIE chromaticity coordinates should be as follows: <table style="margin-left: auto; margin-right: auto;"> <tr> <td></td> <td>X</td> <td>Y</td> </tr> <tr> <td>G</td> <td>0.310</td> <td>0.595</td> </tr> <tr> <td>B</td> <td>0.155</td> <td>0.070</td> </tr> <tr> <td>R</td> <td>0.630</td> <td>0.340</td> </tr> </table>		X	Y	G	0.310	0.595	B	0.155	0.070	R	0.630	0.340	The CIE chromaticity coordinates should be as follows: <table style="margin-left: auto; margin-right: auto;"> <tr> <td></td> <td>X</td> <td>Y</td> </tr> <tr> <td>G</td> <td>0.300</td> <td>0.600</td> </tr> <tr> <td>B</td> <td>0.150</td> <td>0.060</td> </tr> <tr> <td>R</td> <td>0.640</td> <td>0.330</td> </tr> </table>		X	Y	G	0.300	0.600	B	0.150	0.060	R	0.640	0.330
	X	Y																								
G	0.310	0.595																								
B	0.155	0.070																								
R	0.630	0.340																								
	X	Y																								
G	0.300	0.600																								
B	0.150	0.060																								
R	0.640	0.330																								
Reference white	D65. The CIE chromaticity coordinates should be as follows: $x = 0.3127, y = 0.3290$	D65. The CIE chromaticity coordinates should be as follows: $x = 0.3127, y = 0.3290$																								
Luminance (Y) /color-difference signal equation	The equations of Y, P _B , and P _R should be as follows: $Y = 0.587 \times G + 0.114 \times B + 0.299 \times R$ $P_B = 0.564 \times (B-Y)$ $P_R = 0.713 \times (R-Y)$ Note that G, B, and R correspond to gamma pre-corrected signals.	The equations of Y, P _B , and P _R should be as follows: $Y = 0.47152 \times G + 0.0722 \times B + 0.2126 \times R$ $P_B = 0.5389 \times (B-Y)$ $P_R = 0.6350 \times (R-Y)$ Note that G, B, and R correspond to gamma pre-corrected signals.																								
Gamma correction characteristic	$V_c = 1.099X_{Lc} (^{0.4500}) - 0.099$ $(0.018 \leq L_c \leq 1)$ $= 4.500X_{Lc} (0 \leq L_c \leq 0.018),$ where V _c is the video-signal camera output, and L _c is the input light of the camera. Both values must be normalized by the reference white.	$V_c = 1.099X_{Lc} (^{0.4500}) - 0.099$ $(0.018 \leq L_c \leq 1)$ $= 4.500X_{Lc} (0 \leq L_c \leq 0.018),$ where V _c is the video-signal camera output, and L _c is the input light of the camera. Both values must be normalized by the reference white.																								

- Remarks :
- : This standard is not intended to define terminal names.
 - : With respect to (5) and (6), luminance (Y)/synchronizing signals should have a V/S ratio of + 714 mV/-286 mV.
 - : This standard is designed for use with BS digital broadcasting and, in particular, is not intended to define the permissible deviation.

6.1.3.2 Identification output of the format type

The output of identification signals of the format type is optional. However, with the adoption of a D terminal, it is possible to transmit format identification signals (480i, 480p, 720p, 1080i) and the aspect ratio to a television broadcasting receiver.

6.1.3.3 Digital output

(1) Digital video output

Receiver units equipped with DVI interfaces shall comply with the Digital Visual Interface issued by the Digital Display Working Group (DDWG).

(2) Digital audio-video output

Receiver units equipped with HDMI interfaces shall comply with the High-Definition Multimedia Interface Specification issued by the HDMI Licensing, LLC.digital interface.

6.1.4 Copy protection

The receiver should be equipped with a copy guard management system specified by the broadcast service carrier.

6.2 Audio decoding process and output

The following specification shall be applied to any and elementary stream if not specified otherwise.

6.2.1 Audio decoding process

It shall conform to the LC profile of MPEG2-AAC (ISO/IEC 13818-7) and ADTS (AudioDataTransportStream) system. Furthermore, it shall conform to the following restrictions.

- (1) Sampling frequency : Corresponds to 48KHz, 44.1KHz, 32KHz, 24KHz, 22.05KHz, 16KHz
- (2) Quantized bit number : Corresponds to reproduction at 16 bits
- (3) Decodable number of channels : Corresponds to AAC stream up to 5.1 channels per ADTS.
- (4) Number of maximum multiple ADTS : Corresponds to a maximum of 8 ADTS streams within the same program.
- (5) Audio decoding functions : Decodes audio modes of monaural, stereo, multi-channel stereo (3/1, 3/2, 3/2+LFE) and 2-audio (dual monaural).

Note: Multi-channel stereo (3/1, 3/2, 3/2+LFE) means the number of audio channels to the assumed front and rear speakers. (Ex: 3/1 = 3 speakers in front + 1 at rear, 3/2 = 3 speakers in front + 2 at rear). LFE is an abbreviation of Low Frequency Enhancement, which means low frequency enhanced channel.

- (6) Decoding process when switching the audio mode and coded parameter at the transmission side

It shall return to normal operation without making noise within the muting time of audio parameter switching, in accordance With ARIB STD-B32.

- (7) Down mixing function from multi-channel to 2-channel stereo.

- (7-1) Down mixing process to 2-channel stereo

When a receiver with the capability of 2-channel stereophonic reproduction reproduces the multi-channel audio stream, it shall perform the down mixing process shown in Table 6-DM1. There is hereby a possibility of overloading but noise shall not occur even in such case (it may not be turned back even at maximum audio level or more).

Note: For the method to realize the above functions, there are several methods such as automatic volume adjustment after AAC decoder or preventing overload by increasing quantifying bit number, etc. along with such simple methods as implementing a clipping process. The realization method shall be decided by the product planning division.

Table 6-DM1 Formula of down mixing audio signal to 2-channel stereo

Bit value of the received AAC stream			Signalprocess at receiver	
matrix_mix_down_idx_present	pseudo_surround_enable	matrix_mixdown_idx	Value of k	Formula of down mixing audio signal: Note 1
1	0/1: Note 5	0	$1/\sqrt{2}$	Set1: Note 2, Note 3 $L_t = a*(L+1/\sqrt{2}*C+k*Sl)$ $R_t = a*(R+1/\sqrt{2}*C+k*Sr)$ $a=1/\sqrt{2}$
		1	$1/2$	
		2	$1/2\sqrt{2}$	
		3	0	
0 Note 6				Set3: Note 3, Note 4 $L_t=(1/\sqrt{2})*(L+1/\sqrt{2}*C+1/\sqrt{2}*Sl)$ $R_t=(1/\sqrt{2})*(R+1/\sqrt{2}*C+1/\sqrt{2}*Sr)$

Note 1: L means the left front channel of the 3/2 system audio, C, the center channel, R, the right front channel, Sl, the left rear channel, and Sr, the right rear channel. Lt and Rt indicate the stereo audio left and right channels, respectively, generated by down mixing.

Note 2: The above formulas are different from those described in Section 3.3.8.3 "Matrix-mixdown process" in ISO/IEC 13818-7 as to the a-value of the total audio volume term. The a-value is defined so as to make the audio volume generated by the 2-channel stereo audio stream as close as possible to the volume of the 2-channel stereo audio generated by decoding the multi-channel audio stream and down mixing. For the detailed information, refer to Appendix 4.

Note 3: The Set 1 or Set 3 formulas are also used when transmitting LFE signals in the 3/2+LFE multi-channel stereo.

Note 4: Because k cannot be transmitted in the 3/1 system, the down mixing process is expressed by substituting Sl and Sr for the surround signal S of the 3/1 system in the Set 3 formulas ($S = Si = Sr$).

Note 5: The Set 1 formulas are used regardless of the pseudo_surround_enable value. As described in (7-2), however, the Set 2 formulas can be added as an option when pseudo_surround_enable = "1".

Note 6: When PCE is not acquired, the down mixing process for the case of matrix_mixdown_idx_present = "0" shall be used.

(7-2) Down mixing process for external pseudo-surround processor

When down mixing to 2-channel stereo signals for surround audio reproduction using an external pseudo-surround processor, the down mixing process shown in Table 6-DM2 can be added as an option.

Table 6-DM2 Formula of down mixing audio signal for external pseudo-surround processor

Bit value of the received AAC stream			Signalprocess at receiver	
matrix_mix_down_idx_present	pseudo_surround_enable	matrix_mixdown_idx	Value of k	Formula of down mixing audio signal
1	1	0	$1/\sqrt{2}$	Set2: Note $L_t = a*(L+1/\sqrt{2}*C - k(S_l + S_r))$ $R_t = a*(R+1/\sqrt{2}*C + k(S_l + S_r))$ $a=1/\sqrt{2}$
		1	$1/2$	
		2	$1/2\sqrt{2}$	
		3	0	

Note: The above formulas are different from those described in Section 3.3.8.3 "Matrix-mixdown process" in ISO/IEC 13818-7 as to the a-value of the total audio volume term. The a-value is defined so as to make the audio volume generated by the 2-channel stereo audio stream as close as possible to the volume of the 2-channel stereo audio generated by decoding the multi-channel audio stream and down mixing. For the detailed information, refer to Appendix 4.

(7-3) Down mixing process for stereo audio field extension

To reproduce a simulated surround stereo audio field in 2-channel stereo reproduction, down mixing can be added as an option. Although the details of the down mixing process shall be decided by the product planning division, the process must satisfy the following requirements:

- The audio volume generated by the 2-channel stereo audio stream should be as close as possible to the volume of the 2-channel stereo audio generated by decoding the multi-channel audio stream and down mixing.
- Overloading may occur when audio volume is sustained during down mixing, but noise shall not occur even in such a case.

6.2.2 Audio mode discrimination and indication

- (1) Monaural, stereo and multi channel stereo (3/1, 3/2, 3/2+LFE), 2 audio (dual monaural) audio mode correspond to each discrimination and indication. However, the audio mode of an entire program comprised of multiple audio elementary streams shall be a combination of the above audio modes.
- (2) It shall correspond to discrimination and indication of bilingual/2-audio mode.
- (3) It shall correspond to discrimination and indication of mode 1/mode 2/mode 3.

6.2.3 Audio output

6.2.3.1 Audio output function

It shall be equipped with an audio output function of 2-channel stereo or more.

6.2.3.2 Analog audio output

- (1) Output level: 250mVrms+/-3dB (at FS -18dB)
- (2) Output impedance: 2.2k ohm or less
- (3) Loaded impedance: 10k ohm

(4) Output terminal construction: RCA-pin connector

6.2.3.3 Audio-signal output interface for multi-channel

Recommended to conform to the standard of IEC 61937-6 (2006-01) Digital audio - Interface for non-linear PCM encoded audio bitstreams applying IEC 60958 - Part 6: Non-linear PCM bitstreams according to the MPEG-2 AAC and MPEG-4 AAC audio formats or have IEEE-1394 compliant output.

6.2.3.4 Audio output using Bluetooth

Recommended to conform to the standard of Bluetooth SIG: Advanced Audio Distribution Profile (A2DP)*.

* http://www.bluetooth.org/foundry/adopters/document/A2DP_Spec_V1_0/

6.3 Receiver's function of hierarchical modulation in digital satellite broadcasting

6.3.1 Hierarchical modulating signal

A hierarchical modulating should be transmitted in conformity with the ARIB standard (ARIB STD-B20).

6.3.2 Identification of hierarchical modulation

- (1) The presence of hierarchical modulation should be identified by means of a hierarchical transmission descriptor in the received MPEG stream PMT.

For every stream having a hierarchical structure, an elementary stream PID to be checked for reference is obtained and identified by means of reference_PID of the hierarchical transmission descriptor.

- (2) The hierarchies should be of two levels.

High and low hierarchies should be identified by means of quality_level of the hierarchical transmission descriptor.

- (3) Signals of high and low hierarchies should be transmitted in the same TS and in the same service ID, respectively.

6.3.3 Reception processing of hierarchical modulation

- (1) When the error rate of the received signal or its equivalent index exceeds a fixed value, the receiver must automatically switch over from the high hierarchy to the low hierarchy and display the received signal.
- (2) In cases in which the same video information is simultaneously transmitted in both the high and low hierarchies, a function for representing and outputting video of both hierarchies simultaneously in the receiver is not required. Moreover, with respect to the audio, such a function is also unnecessary.

6.3.4 Display of low-hierarchy video in hierarchical modulation

The format for the video output signals should conform to definition described in 6.1.2. Note that it is desirable, in the case of the output of a reduced moving picture, that the relationship between

the parameter values of `sequence_display_extension` of the low hierarchical video stream and the video-signal output conform to Table 6-9 when the video signal is output in the 525i signal; Table 6-10 when it is output in the 1125i or 525p signal; and Table 6-11 when it is output in the 750p signal. Further, it is desirable, in the case of the output of a still picture, that the above-mentioned relationship conform to Table 6-12 when the video signal is output in the 525i signal; Table 6-13 when it is output in the 1125i or 525p signal; and Table 6-14 when it is output in the 750p signal. However, this definition shall not apply to cases in which the video is displayed by means of multi-media coding.

Table 6-9 Relationship between the parameter values of sequence_display_extension of reduced moving pictures and video output signals (1)

Reference drawing	Parameter values of sequence_header			Parameter values of sequence_extension	Parameter values of sequence_display_extension		Output video signal in 525i format to a 4:3 monitor (720 pixels horizontally)			Output video signal in 525i format to a 16:9 monitor (720 pixels horizontally)		
	vertical_size_value (A)	horizontal_size_value (B)	aspect_ratio_Information	progressive_sequence	display_vertical_size (C)	display_horizontal_size (D)	Vertical scaling ratio (L: line)	Horizontal scaling ratio (S: sample)	Remark	Vertical scaling ratio (L: line)	Horizontal scaling ratio (S: sample)	Remark
1)	240	352	3	1	240	360	A x (3/2) + 120L black	B x 2 + 16S black	1	A x 2	B x 2 + 16S black	5
2)					480	720	A x (3/4) + 300L black	B x 1 + 368S black	2	A x 1 + 240L black	B x 1 + 368S black	6
3)	240	352	2	1	240	360	A x 2	B x 2 + 16S black	3	A x 2	B x (3/2) + 192S black	7
4)					480	720	A x 1 + 240L black	B x 1 + 368S black	4	A x 1 + 240L black	B x (3/4) + 456S black	8

Table 6-10 Relationship between the parameter values of sequence_display_extension for reduced moving pictures and video output signals (2)

Reference drawing	Parameter values of sequence_header			Parameter values of sequence_extension	Parameter values of sequence_display_extension		Output video signal in 525p format to a 16:9 monitor (720 pixels horizontally)			Output video signal in 1125i format to a 16:9 monitor (1920 pixels horizontally)		
	vertical_size_value (A)	horizontal_size_value (B)	aspect_ratio_Information	progressive_sequence	display_vertical_size (C)	display_horizontal_size (D)	Vertical scaling ratio (L: line)	Horizontal scaling ratio (S: sample)	Remark	Vertical scaling ratio (L: line)	Horizontal scaling ratio (S: sample)	Remark
1)	240	352	3	1	240	360	A x 2	B x 2 + 16S black	5	A x (9/2)	B x (16/3) + 43S black	5
2)					480	720	A x 1 + 240L black	B x 1 + 368S black	6	A x (9/4) + 540L black	B x (8/3) + 982S black	6
3)	240	352	2	1	240	360	A x 2	B x (3/2) + 192S black	7	A x (9/2)	B x 4 + 512S black	7
4)					480	720	A x 1 + 240L black	B x (3/4) + 456S black	8	A x (9/4) + 540L black	B x 2 + 1216S black	8

Table 6-11 Relationship between the parameter values of sequence_display_extension for reduced moving pictures and video output signals (3)

Reference drawing	Parameter values of sequence_header			Parameter values of sequence_extension	Parameter values of sequence_display_extension		Output video signal in 750p format to a 16:9 monitor (1280 pixels horizontally)		
	vertical_size_value (A)	horizontal_size_value (B)	aspect_ratio_information	progressive_sequence	display_vertical_size (C)	display_horizontal_size (D)	Vertical scaling ratio (L: line)	Horizontal scaling ratio (S: sample)	Remark
1)	240	352	3	1	240	360	A x 3	B x (32/9) + 29S black	5
2)					480	720	A x (3/2) + 360L black	B x (16/9) + 655S black	6
3)	240	352	2	1	240	360	A x 3	B x (8/3) + 342S black	7
4)					480	720	A x (3/2) + 360L black	B x (4/3) + 811S black	8

Note 1: When sequence_display_extension is not transmitted, the receiver should process assuming that the values of display_vertical_size(C) and display_horizontal_size(D) are equal to those of vertical_size_value(A) and horizontal_size_value(B) in sequence_header. However, when B is 352, the signal processing must be conducted in the same manner as when D is 360. When D is transmitted as 352, the receiver should process in the same manner as when D is not transmitted.

Note 2: The functions of the receiver may be limited based on the assumption that low hierarchical video is displayed using frame_center_horizontal_offset (FCHO) and frame_center_vertical_offset (FCVO) in picture_display_extension is normally zero. When picture_display_extension is not transmitted, FCHO and FCVO are interpreted as zero.

Note 3: The scaling ratio of the 4:3 monitor may not apply to S1 (type having a 4:3 monitor and a vertical deflection amplitude that can be altered)-compliant apparatuses.

[Remarks]

1. An image transmitted in a 16:9 aspect ratio is displayed in the letterbox format on a 4:3 monitor (see type #1 of the reference drawing).
2. An image transmitted in a 16:9 aspect ratio is displayed in a window on a 4:3 monitor (see type #2 of the reference drawing).
3. An image transmitted in a 4:3 aspect ratio is displayed in full-screen mode on a 4:3 monitor (see type #3 of the reference drawing).
4. An image transmitted in a 4:3 aspect ratio is displayed in a window on a 4:3 monitor (see type #4 of the reference drawing).
5. An image transmitted in a 16:9 aspect ratio is displayed in full-screen mode on a 16:9 monitor (see type #1 of the reference drawing).
6. A image transmitted in a 16:9 aspect ratio is displayed in a window on a 16:9 monitor (see type #2 of the reference drawing).
7. An image transmitted in a 4:3 aspect ratio is displayed on a 16:9 monitor. The active image region is located in the middle of the monitor, and lateral margins external to the region are shown in black (see type #3 of the reference drawing).
8. An image transmitted in a 4:3 aspect ratio is displayed in a window on a 16:9 monitor (see type #4 of the reference drawing).

Table 6-12 Relationship between the parameter values of sequence_display_extension for still pictures and video output signals (1)

Reference drawing	Parameter values of sequence_header			Parameter values of sequence_extension	Parameter values of sequence_display_extension		Output video signal in 525I format to a 4:3 monitor (720 pixels horizontally)			Output video signal in 525i format to a 16:9 monitor (720 pixels horizontally)		
	vertical_size_value (A)	horizontal_size_value (B)	aspect_ratio_information	progressive_sequence	display_vertical_size (C)	display_horizontal_size (D)	Vertical scaling ratio (L: line)	Horizontal scaling ratio (S: sample)	Remark	Vertical scaling ratio (L: line)	Horizontal scaling ratio (S: sample)	Remark
1)	1080	1920	3	0	1080	1920	A x (1/3) + 120L black	B x (3/8)	1	A x (4/9)	B x (3/8)	5
		1440				B x (1/2)	B x (1/2)					
	480	720	1	480	720	A x (3/4) + 120L black	B x 1	A x 1		B x 1		
	480	720	0	480	720	A x (3/4) + 120L black	B x 1	A x 1		B x 1		
2)	240	352	3	1	240	360	A x (3/2) + 120L black	B x 2 + 16S black	2	A x 2	B x 2 + 16S black	6
					480	720	A x (3/4) + 300L black	B x 1 + 368S black			A x 1 + 240L black	
3)	480	720	2	0	480	720	A x 1	B x 1	3	A x 1	B x (3/4) + 180S black	7
4)	240	352	2	1	240	360	A x 2	B x 2 + 16S black		A x 2	B x (3/2) + 192S black	
					480	720	A x 1 + 240L black	B x 1 + 368S black	4	A x 1 + 240L black	B x (3/4) + 456S black	8

Table 6-13 Relationship between the parameter values of sequence_display_extension for still pictures and video output signals (2)

Reference drawing	Parameter values of sequence_header			Parameter values of sequence_extension	Parameter values of sequence_display_extension		Output video signal in 525p format to a 16:9 monitor (720 pixels horizontally)			Output video signal in 1125i format to a 16:9 monitor (1920 pixels horizontally)		
	vertical_size_value (A)	horizontal_size_value (B)	aspect_ratio_information	progressive_sequence	display_vertical_size (C)	display_horizontal_size (D)	Verticalenlarge scaling ratio (L: line)	Horizontal scaling ratio (S: sample)	Remark	Vertical scaling ratio (L: line)	Horizontal scaling ratio (S: sample)	Remark
1)	1080	1920	3	0	1080	1920	A x (4/9)	B x (3/8)	5	A x 1	B x 1	5
		1440				B x (1/2)		B x (4/3)				
	480	720	3	1	480	720	A x 1	B x 1		A x (9/4)	B x (8/3)	
	480	720	3	0	480	720	A x 1	B x 1		A x (9/4)	B x (8/3)	
2)	240	352	3	1	240	360	A x 2	B x 2 + 16S black	6	A x (9/4) + 540L black	B x (16/3) + 43S black	6
					480	720	A x 1 + 240L black	B x 1 + 368S black			B x (8/3) + 982S black	
3)	480	720	2	0	480	720	A x 1	B x (3/4) + 180S black	7	A x (9/4)	B x 2 + 480S black	7
4)	240	352	2	1	240	360	A x 2	B x (3/2) + 192S black			A x (9/2)	
					480	720	A x 1 + 240L black	B x (3/4) + 456S black	8	A x (9/4) + 540L black	B x 2 + 1216S black	8

Table 6-14 Relationship between the parameter values of sequence_display_extension for still pictures and video output signals (3)

Reference drawing	Parameter values of sequence_header			Parameter values of sequence_extension	Parameter values of sequence_display_extension		Output video signal in 750p format to a 16:9 monitor (1280 pixels horizontally)		
	vertical_size_value (A)	horizontal_size_value (B)	aspect_ratio_information	progressive_sequence	display_vertical_size (C)	display_horizontal_size (D)	Vertical scaling ratio (L: line)	Horizontal scaling ratio (S: sample)	Remark
1)	1080	1920	3	0	1080	1920	A x (2/3)	B x (2/3)	5
		1440				1440		B x (8/9)	
	480	720	3	1	480	720	A x (3/2)	B x (16/9)	
	480	720	3	0	480	720	A x (3/2)	B x (16/9)	
2)	240	352	3	1	240	360	A x 3	B x (32/9) + 29S black	6
					480	720	A x (3/2) + 360L black	B x (16/9) + 655S black	
3)	480	720	2	0	480	720	A x (3/2)	B x (4/3) + 320S black	7
4)	240	352	2	1	240	360	A x 3	B x (8/3) + 342S black	
					480	720	A x (3/2) + 360L black	B x (4/3) + 811S black	8

Note 1: When sequence_display_extension is not transmitted, the receiver should process assuming that the values of display_vertical_size(C) and display_horizontal_size(D) are equal to those of vertical_size_value(A) and horizontal_size_value(B) in sequence_header. However, when B is 352, the signal processing should be conducted in the same manner as when D is 360. When D is transmitted as 352, the receiver process in the same manner as when D is not transmitted.

Note 2: The functions of the receiver may be limited based on the assumption that processing is conducted with frame_center_horizontal_offset (FCHO) and frame_center_vertical_offset (FCVO) in picture_display_extension normally being zero. When picture_display_extension is not transmitted, FCHO and FCVO are interpreted as zero.









Note 3: The scaling ratio of the 4:3 monitor stipulated here shall not apply to S1 (type with a 4:3 monitor with a vertical deflection amplitude that can be altered)-compliant apparatuses.

[Remarks]

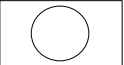
1. An image transmitted in a 16:9 aspect ratio is displayed in the letterbox format on a 4:3 monitor (see type #1 of the reference drawing).
2. An image transmitted in a 16:9 aspect ratio is displayed in a window on a 4:3 monitor (see type #2 of the reference drawing).
3. An image transmitted in a 4:3 aspect ratio is displayed in full-screen mode on a 4:3 monitor (see type #3 of the reference drawing).
4. An image transmitted in a 4:3 aspect ratio is displayed in a window on a 4:3 monitor (see type #4 of the reference drawing).
5. An image transmitted in a 16:9 aspect ratio is displayed in full-screen mode on a 16:9 monitor (see type #1 of the reference drawing).
6. An image transmitted in a 16:9 aspect ratio is displayed in a window on a 16:9 monitor (see type #2 of the reference drawing).
7. An image transmitted in a 4:3 aspect ratio is displayed on a 16:9 monitor. The real image region is located in the middle of the monitor, and lateral margins external to the region are shown in black (see type #3 of the reference drawing).
8. An image transmitted in a 4:3 aspect ratio is displayed in a window on a 16:9 monitor (see type #4 of the reference drawing).

Meaning of each code index of the MPEG-2 coding parameters given in Tables 6-9 to 14	
aspect_ratio_information	2 = 4:3 display, 3 = 16:9 display
progressive_sequence	0 = interlaced scanning scheme, 1 = progressive scanning scheme

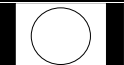
[Reference drawing]

type	Encoder input image	4:3 monitor	16:9 monitor
1)	 16:9		
2)			
3)	 4:3		
4)			

6.4 Indication of MP@LL animation and still picture in digital terrestrial television broadcasting

6.4.1 Operation of MP@LL animation and still picture

MP@LL animation and still picture is transmitted and operated in accordance with the standard document (ARIB STD-B31) and can be operated as a video coding of mobile service in hierarchy transmission.

6.4.2 Indication for the receiver

For the video output signal format, it shall be in accordance with chapter 6.1.2.

For the relation of the parameter value of `sequence_display_extension` of MP@LL animation and still picture stream, and video signal output, it is recommended to be in accordance with Table 6-15 when the output signal is 525i in reduction animation, Table 6-16 when the output signal is 1125i or 525i, and Table 6-17 when the output signal is 750i. Also, it is recommended to be in accordance with Table 6-18 when the output signal is 525i in still picture, Table 6-19 when the output signal is 1125i or 525p, and Table 6-20 when the output signal is 750p.

However, when indicated by multimedia coding, the specification is beyond the scope of this document.

Table 6-15 Relation of the parameter value of sequence_display_extension of a reduction animation and the video output signal (1)

*1	Parameter value of sequence_header			Parameter value of sequence_extension	Parameter value of sequence_display_extension		When output to 525i signal 4:3 monitor (horizontal 720 pixel)			When output to 525i signal 16:9 monitor (horizontal 720 pixel)		
	vertical_size_value (A)	horizontal_size_value (B)	Aspect_ratio_Information	progressive_sequence	display_vertical_size (C)	display_horizontal_size (D)	Vertical Extension and reduction rate (L:line)	Horizontal Extension and reduction rate (S:sample)	*2	Vertical Extension and reduction rate (L:line)	Horizontal Extension and reduction rate (S:sample)	*2
1)	240	352	3	1	240	360	A×(3/2) +120L black	B×2 +16S black	1	A×2	B×2 +16S black	5
2)					480	720	A×(3/4) +300L black	B×1 +368S black	2	A×1 +240L black	B×1 +368S black	6
3)	240	352	2	1	240	360	A×2	B×2 +16S black	3	A×2	B×(3/2) +192S black	7
4)					480	720	A×1 +240L black	B×1 +368S black	4	A×1 +240L black	B×(3/4) +456S black	8

*1: Reference figure

*2: Remarks

Table 6-16 Relation of parameter value of sequence_display_extension of reduction animation and the video output signal (2)

*1	Parameter value of sequence_header			Parameter value of sequence_extension	Parameter value of sequence_display_extension		When output to 525p signal 16:9 monitor (horizontal 720 pixel)			When output to 1125i signal 16:9 monitor (horizontal 1920 pixel)		
	vertical_size_value (A)	horizontal_size_value (B)	Aspect_ratio_Information	progressive_sequence	display_vertical_size (C)	display_horizontal_size (D)	Vertical Extension and reduction rate (L:line)	Horizontal Extension and reduction rate (S:sample)	*2	Vertical Extension and reduction rate (L:line)	Horizontal Extension and reduction rate (S:sample)	*2
1)	240	352	3	1	240	360	A×2	B×2 +16S black	5	A×(9/2)	B×(16/3) +43S black	5
2)					480	720	A×1 +240L black	B×1 +368S black	6	A×(9/4) +540L black	B×(8/3) +982S black	6
3)	240	352	2	1	240	360	A×2	B×(3/2) +192S black	7	A×(9/2)	B×4 +512S black	7
4)					480	720	A×1 +240L black	B×(3/4) +456S black	8	A×(9/4) +540L black	B×2 +1216S black	8

*1: Reference figure

*2: Remarks

Table 6-17 Relation of the parameter value of sequence_display_extension of the reduction animation and the video output signal (3)

* 1	Parameter value of sequence_header			Parameter value of sequence_extension	Parameter value of sequence_display_extension		When output to 750p signal 16:9 monitor (horizontal 1280 pixel)		
	vertical_size_value (A)	Horizontal_Size_value (B)	aspect_ratio_information	progressive_sequence	display_vertical_size (C)	display_horizontal_size (D)	Vertical Extension and reduction rate (L:line)	Horizontal Extension and reduction rate (S:sample)	*2
1)	240	352	3	1	240	360	A×3	B×(32/9) +29S black	5
2)					480	720	A×(3/2) +360L black	B×(16/9) +655S black	6
3)	240	352	2	1	240	360	A×3	B×(8/3) +342S black	7
4)					480	720	A×(3/2) +360L black	B×(4/3) +811S black	8

*1: Reference figure

*2: Remarks

Note 1: When the sequence_display_extension is not transmitted, each value of display_vertical_size(C) and display_horizontal_size(D) shall be processed in the receiver side as the same value as vertical_size_value(A) and horizontal_size_value(B) indicated in the sequence_header. However, when B is 352, the signal processing shall be the same as when D is 360. When the transmission is made and D is 352, the receiver shall process similar to the case when D is not transmitted.

Note 2: The receiver may restrict the function on condition that the frame_center_horizontal_offset(FCHO) and frame_center_vertical_offset(FCVO) of picture_display_extension is always operated at zero. When picture_display_extension is not transmitted, it is interpreted that FCHO and FCVO are zero.

Note 3: The model corresponding to S1(a type which can change the horizontal deflection amplitude with a 4:3 monitor) is not within the scope of the 4:3 monitor extension and reduction ratio specified herein.

[Remarks]

1. Indicates the case when the picture transmitted by the aspect ratio 16:9 is indicated in a letter box format in a 4:3 monitor. (See Fig. 1)
2. Indicates the case when the picture transmitted by the aspect ratio 16:9 is indicated in a window in a 4:3 monitor .(See Fig. 2)
3. Indicates the case when the picture transmitted by the aspect ratio 4:3 is indicated in a full picture in a 4:3 monitor .(See Fig. 3)
4. Indicates the case when the picture transmitted by the aspect ratio 4:3 is indicated in a window in a 4:3 monitor .(See Fig. 4)
5. Indicates the case when the picture transmitted by the aspect ratio 16:9 is indicated in a full picture in a 16:9 monitor .(See Fig. 1)
6. Indicates the case when the picture transmitted by the aspect ratio 16:9 is indicated in a window in a 16:9 monitor .(See Fig. 2)
7. Indicates the case when the picture transmitted by the aspect ratio 4:3 is indicated in a 16:9 monitor. The real picture area is located in the center of the monitor and both sides are black. (See Fig. 3)
8. Indicates the case when the picture transmitted by the aspect ratio 4:3 is indicated in a window in a 16:9 monitor. (See Fig. 4)

Table 6-18 Relation of the parameter value of sequence_display_extension of the still picture and the video output signal (1)

*1	Parameter value of sequence_header			Parameter value of sequence_extension	Parameter value of sequence_display_extension		When output to 525i signal 4:3 monitor (horizontal 720 pixel)			When output to 525i signal 16:9 monitor (horizontal 720 pixel)		
	vertical_size_value (A)	horizontal_size_value (B)	aspect_ratio_information	progressive_sequence	display_vertical_size (C)	display_horizontal_size (D)	Vertical Extension and reduction rate (L:line)	Horizontal Extension and reduction rate (S:sample)	*2	Vertical Extension and reduction rate (L:line)	Horizontal Extension and reduction rate (S:sample)	*2
1)	1080	1920	3	0	1080	1920	A×(1/3) +120L black	B×(3/8)	1	A×(4/9)	B×(3/8)	5
		1440				B×(1/2)		B×(1/2)				
	480	720	3	1	480	720	A×(3/4) +120L black	B×1	A×1	B×1		
	480	720	3	0	480	720	A×(3/4) +120L black	B×1	A×1	B×1		
2)	240	352	3	1	240	360	A×(3/2) +120L black	B×2 +16S black	2	A×1 +240L black	B×1 +368S black	6
					480	720	A×(3/4) +300L black	B×1 +368S black				
3)	480	720	2	0	480	720	A×1	B×1	3	A×1	B×(3/4) +180S black	7
	240	352	2	1	240	360	A×2	B×2 +16S black			A×2	
4)	240	352	2	1	480	720	A×1 +240L black	B×1 +368S black	4	A×1 +240L black	B×(3/4) +456S black	8

*1: Reference figure

*2: Remarks

Table 6-19 Relation of the parameter value of sequence_display_extension of the still picture and video output signal (2)

*1	Parameter value of sequence_header			Parameter value of sequence_extension	Parameter value of sequence_display_extension		When output to 525p signal 16:9 monitor (horizontal 720 pixel)			When output to 1125i signal 16:9 monitor (horizontal 1920 pixel)		
	vertical_size_value (A)	horizontal_size_value (B)	aspect_ratio_information	progressive_sequence	display_vertical_size (C)	display_horizontal_size (D)	Vertical Extension and reduction rate (L:line)	Horizontal Extension and reduction rate (S:sample)	*2	Vertical Extension and reduction rate (L:line)	Horizontal Extension and reduction rate (S:sample)	*2
1)	1080	1920	3	0	1080	1920	$A \times (4/9)$	$B \times (3/8)$	5	$A \times 1$	$B \times 1$	5
		1440				$B \times (1/2)$		$B \times (4/3)$				
	480	720	3	1	480	720	$A \times 1$	$B \times 1$		$A \times (9/4)$	$B \times (8/3)$	
	480	720	3	0	480	720	$A \times 1$	$B \times 1$		$A \times (9/4)$	$B \times (8/3)$	
2)	240	352	3	1	240	360	$A \times 2$	$B \times 2$ +16S black	6	$A \times (9/4)$ +540L black	$B \times (16/3)$ +43S black	6
					480	720	$A \times 1$ +240L black	$B \times 1$ +368S black			$B \times (8/3)$ +982S black	
3)	480	720	2	0	480	720	$A \times 1$	$B \times (3/4)$ +180S black	7	$A \times (9/4)$	$B \times 2$ +480S black	7
							$A \times 2$	$B \times (3/2)$ +192S black			$B \times 4$ +512S black	
4)	240	352	2	1	480	720	$A \times 1$ +240L black	$B \times (3/4)$ +456S black	8	$A \times (9/4)$ +540L black	$B \times 2$ +1216S black	8

*1: Reference figure

*2: Remarks

Table 6-20 Relation of the parameter value of sequence_display_extension of the still picture and video output signal (3)

*1	Parameter value of sequence_header			Parameter value of sequence_extension	Parameter value of sequence_display_extension		When output to 750p signal 16:9 monitor (horizontal 1280 pixel)		
	vertical_size_value (A)	Horizontal_Size_value (B)	aspect_ratio_information	progressive_sequence	display_vertical_size (C)	display_horizontal_size (D)	Vertical Extension and reduction rate (L:line)	Horizontal Extension and reduction rate (S:sample)	*2
1)	1080	1920	3	0	1080	1920	A × (2/3)	B × (2/3)	5
		1440				1440		B × (8/9)	
	480	720	3	1	480	720	A × (3/2)	B × (16/9)	
	480	720	3	0	480	720	A × (3/2)	B × (16/9)	
2)	240	352	3	1	240	360	A × 3	B × (32/9) +29S black	6
					480	720	A × (3/2) +360L black	B × (16/9) +655S black	
3)	480	720	2	0	480	720	A × (3/2)	B × (4/3) +320S black	7
								240	
4)	240	352	2	1	480	720	A × (3/2) +360L black	B × (4/3) +811S black	8

*1: Reference figure

*2: Remarks

Note 1: When the sequence_display_extension is not transmitted, each value of display_vertical_size(C) and display_horizontal_size(D) shall be processed in the receiver side as the same value as vertical_size_value(A) and horizontal_size_value(B) indicated in the sequence_header. However, when B is 352, the signal processing shall be the same as in case when D is 360. When the transmission is made and D is 352, the receiver shall process similar to the case when D is not transmitted.

Note 2: The receiver may restrict the function on condition that the frame_center_horizontal_offset(FCHO) and frame_center_vertical_offset(FCVO) of picture_display_extension is always operated at zero. When picture_display_extension is not transmitted, it is interpreted that FCHO and FCVO are zero.









Note 3: The model corresponding to S1(a type which can change the horizontal deflection amplitude with a 4:3 monitor) is not within the scope of the 4:3 monitor extension and reduction ratio specified herein.

[Remarks

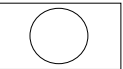
1. Indicates the case when the picture transmitted by the aspect ratio 16:9 is indicated in a letter box format in a 4:3 monitor. (See Fig. 1)
2. Indicates the case when the picture transmitted by the aspect ratio 16:9 is indicated in a window in a 4:3 monitor .(See Fig. 2)
3. Indicates the case when the picture transmitted by the aspect ratio 4:3 is indicated in a full picture in a 4:3 monitor .(See Fig. 3)
4. Indicates the case when the picture transmitted by the aspect ratio 4:3 is indicated in a window in a 4:3 monitor .(See Fig. 4)
5. Indicates the case when the picture transmitted by the aspect ratio 16:9 is indicated in a full picture in a 16:9 monitor .(See Fig. 1)
6. Indicates the case when the picture transmitted by the aspect ratio 16:9 is indicated in a window in a 16:9 monitor .(See Fig. 2)
7. Indicates the case when the picture transmitted by the aspect ratio 4:3 is indicated in a 16:9 monitor. The real picture area is located in the center of the monitor and both sides are black. (See Fig. 3)
8. Indicates the case when the picture transmitted by the aspect ratio 4:3 is indicated in a window in a 16:9 monitor. (See Fig. 4)

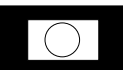
Meaning of each code number of MPEG-2 coding parameter in Tables 6-9 to 14	
aspect_ratio_information	2 = 4:3 indication, 3 = 16:9 indication
progressive_sequence	0 = Inter-scanning 1 = Progressive scanning

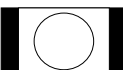
[Reference figures]

type	Encoder input picture	4:3 monitor	16:9 monitor
1)	 16:9		
2)			
3)	 4:3		
4)			

Chapter 7: Specifications of the primary data decoder

The specifications of the primary data decoder must be in accordance with “ARIB STD-B24.”

Chapter 8: Specifications of EPG

The functions of EPG utilizing SI (program guide table representation, program searching, program reservation, etc.) and an EPG user interface are, in principle, a matter of the manufacturers' product planning. However, EPG is a very peculiar function in digital broadcasting, allowing the viewer to select a desired service efficiently. It is therefore recommended that the receiver have as convenient an EPG as possible. Stipulations and guidelines for the EPG function must be satisfied in accordance with the service carrier's specifications.

Chapter 9: Specifications for high-speed digital interfaces

The specifications of serial and IP interfaces are described below as high-speed digital interfaces.

9.1 Specifications of the serial interface

The serial interface shall be in accordance with the IEEE1394 specification and, more specifically, shall conform to IEEE Std 1394-1995, “IEEE Standard for a High Performance Serial Bus.” Refer the original technical data as necessary.

9.1.1 Signal name, functions, and pin layout of the interface

The signal is composed of two twisted-pair interfaces (TPA/TPA*, TPB/TPB*) and power-supply pairs (VP/VG).

Table 9-1 Signal name, functions, and pin layout

Pin number		Name	Function
Connector: 4 pins	Connector: 6 pins		
–	1	VP	Power supply
–	2	VG	GND
1	3	TPB*	Strobe on receive, and data on transmit (differential pair)
2	4	TPB	
3	5	TPA*	Data on receive, and strobe on transmit (differential pair)
4	6	TPA	

*: Active, low signal

TPA and TPA*, TPB and TPB * indicate the standard signal and the reverse signal (with *), respectively, that make up a differential pair.

9.1.2 Signal voltage level and impedance

Table 9-2 Differential output signal amplitude

Max.	Min.	Unit
265	172	mV

Table 9-3 The differential receive signal amplitude

Signal	S100 (mV)*		S200 (mV)*		S400 (mV)*	
	Max.	Min.	Max.	Min.	Max.	Min.
During arbitration	260	173	262	171	265	168
During clocked data reception	260	142	260	132	260	118

*: Code indicating the bit rate of the serial bus

S100: 98.304 Mbit/s

S200: 196.608 Mbit/s

S400: 393.216 Mbit/s

Table 9-4 Differential input impedance

	Max.	Min.	Unit
Receive mode	111	109	Ω
Transmit mode	111	105	Ω

9.1.3 Connector

1394 connector (4 pin, 6 pin)

Using whether 4 pin or 6 pin connector depends on a system which consists of the DIRD and peripheral equipment.

9.1.4 Protocol of the serial interface

The protocol shall be in accordance with the IEC61883-1 and -4 specification. Refer the original specification (IEC61883-1: Consumer Audio/video Equipment-Digital Interface-Part 1: General., IEC61883-4: Consumer Audio/video Equipment-Digital Interface-Part 4: MPEG-2-TS Data Transmission) as necessary.

9.1.5 Descriptors, commands, and tuner models

The digital satellite broadcasting receiver and the digital terrestrial television broadcasting receiver shall be provided with the functions specified below for the AV/C Tuner Subunit, as specified in the 1394 Trade Association (hereinafter referred to as “1394TA”).

The Tuner Subunit shall conform to AV/C Digital Interface Command Set General Specification Version 4.1 (hereinafter referred to as “AV/C General”), AV/C Descriptor Mechanism Specification Version 1.0 (hereinafter referred to as AV/C Descriptor), AV/C Tuner Model and Command Set Version 2.0 (hereinafter referred to as “AV/C Tuner”), AV/C Tuner Broadcast System Specification-Digital Video Broadcast (DVB) Version1.0 (hereinafter “Tuner DVB”), and Enhancements to the AV/C Broadcast System Specification-Digital Video Broadcast (DVB) Version 1.0 (hereinafter referred to as “Enhancements Tuner DVB”), and shall also support the functions specified in Profile 1: The Simplest Tuner Without Lists and Selection by DSIT of Enhancements Tuner DVB.

9.1.5.1 Descriptors

9.1.5.1.1 Descriptor of the satellite digital broadcasting receiver unit

A satellite digital broadcasting receiver in conformity with Profile 1 of Enhancements Tuner DVB shall support the two descriptors specified by AV/C General, AV/C Descriptor and by AV/C Tuner that are shown in Table 9-5. For details on the Tuner Subunit Identifier Descriptor, see AV/C General and AV/C Tuner. For details on the Tuner Status Descriptor, see AV/C Tuner.

Table 9-5 Descriptors

Descriptor	descriptor_type	Description	Support
Tuner Subunit Identifier Descriptor	0x00	Indicating the capabilities/features of the Tuner Subunit	Mandatory
Tuner Status Descriptor	0x80	Indicating the state of the Tuner Subunit	Mandatory

The structures of the descriptors are shown below.

(1) Tuner Subunit Identifier Descriptor

The Tuner Subunit Identifier Descriptor has the structure shown in Table 9-6. The basic structure is specified by AV/C General, and the structure of subunit_dependent_information is specified by AV/C Tuner.

Table 9-6 Tuner Subunit Identifier Descriptor

Structure	Number of bits	Value (Note 1)
descriptor length	16	
generation_ID	8	0x00
size_of_list_ID	8	0x02
size_of_object_ID	8	0x06
size_of_object_position	8	0x02
number_of_root_object_lists	16	[0x0000]
subunit_dependent_length	16	
subunit_dependent_information{		
number_of_systems	8	
for (i=0; i< number_of_systems; i++) {		
system[i]_specification {		
specification_length	16	
system_ID	8	0x20
implementation_profile_id	8	0x10
number_of_subsystem_labels	8	
for (j = 0; j< number_of_subsystem_labels; j++) {		
subsystem_label_length	8	0x09
subsystem_label[1-9]	72	In the case of BS, "JPNBS0004." In the case of broadband CS, "JPNCSxxxx." (See the separate technical data.)
}		
}		
multiplex_preferred_selection_flags	16	0x0000

Structure	Number of bits	Value (Note 1)
service_preferred_selection_flags	8	0x28
number_of_antennas	8	[0x01]
for (k = 0; k < number_of_antennas; k ++) {		
antenna[k]_specification {		
mobile, movable, reserved, transport	8	0x01
input_plug	8	[0x9E]
system_specific_antenna_range_spec_length	16	0x0007
system_specific_antenna_range_spec		
selection_attribute_range_specification_for_A{		
list_flag, range_flag, size_of_attribute(s)	8	0x00
}		
selection_attribute_range_specification_for_B{		
list_flag, range_flag, size_of_attribute(s)	8	0x00
}		
selection_attribute_range_specification_for_C{		
list_flag, range_flag, size_of_attribute(s)	8	0x00
}		
selection_attribute_range_specification_for_D{		
list_flag, range_flag, size_of_attribute(s)	8	0x00
}		
selection_attribute_range_specification_for_E{		
list_flag, range_flag, size_of_attribute(s)	8	0x00
}		
selection_attribute_range_specification_for_F{		
list_flag, range_flag, size_of_attribute(s)	8	0x00
}		
selection_attribute_range_specification_for_G{		
list_flag, range_flag, size_of_attribute(s)	8	0x00
}		
}		
system_specific_info_length	8	0x01
system_specific_info{		
DVB_specification_version	8	0x11
}		
}		
}		
}		
manufacturer_dependent_length	16	0x0000

Note 1: Describing a value for a field in which a fixed value is inserted by the Tuner Status Identifier Descriptor, and for a field in which a value can be set optionally but a default value is specified (the default value being indicated in [])

For the following fields with explanations, see the corresponding description:

- generation_ID
generation_ID is specified by AV/C General and shall be a value shown in Table 9-7.

Table 9-7 Generation_ID

Value	Meaning
0X02	Descriptor structure in conformity with AV/C Descriptor Ver 1.0

- size_of_list_ID, size_of_object_position
size_of_list_ID and size_of_object_position are specified by AV/C Tuner, and shall be values shown in Table 9-8.

Table 9-8 Size_of_list_ID and size_of_object_positon

Item	Value
size_of_list_ID	0x02
size_of_object_position	0x02

- size_of_object_ID
size_of_object_ID is determined based on the limitation (6 bytes) of the service object ID specified by Tuner DVB, and shall be a value shown in Table 9-9.

Table 9-9 Size_of_object_ID

Item	Value
size_of_object_ID	0x06

- number_of_root_object_lists
number_of_root_object_lists basically has no object list in Profile 1, and is therefore normally 0x0000. However, when it has an optional object list or the object list in a Profile other than Profile 1, the number of root object list becomes the value in this field.
- system_ID
system_ID is specified by AV/C Tuner, and shall be a value shown in Table 9-10.

Table 9-10 System_ID

Value	Meaning
0x20	Broadcasting system in conformity with DVB

- implementation_profile_id
implementation_profile_id that indicates Profile 1 is specified by Enhancements Tuner DVB, and shall be a value shown in Table 9-11.

Table 9-11 Implementation_profile_id

Value	Meaning
0x10	Profile1:The Simplest Tuner without Lists and Selection by DSIT

- **number_of_subsystem_labels**
The receiver may distinguish between several satellite broadcaster which it is capable of dealing with such as BS/CS, and may have two or more subsystem_labels.
(A case of a receiver compatible with multiple broadcasters)
- **subsystem_label**
As means for distinguishing (notifying) the service providers that the digital satellite broadcasting receiver can receive, satellite broadcast services (such as BS/CS) in compliant with DVB are distinguished, and all the services that can be received are enumerated.

The length of subsystem_label is 9, fixed, and each label must correspond to each Network ID on a one-to-one basis. Note that the characters that can be used are the letters and numerals of the ASCII code. Subsystem_label of the BS digital broadcast service is JPNBS0004 (0004 being Network_ID). (In the CS digital broadcast service, “JPNCsxxxx” must be assumed (see the separate ARIB technical report).) When the controller detects subsystem_label, the possession of multiple systems and subsystems and the extension of the specifications to Profile 1 and above (for example, receiver supports service Lists) must be considered.

- **multiplex/service_preferred_selection_flags**
“1” is set to bits corresponding to the minimum attribute required for the receiver to select channel together with subsystem_label (minimum combination that enables complete channel selection). For digital satellite broadcasting, at least two attributes shown in Table 9-12 shall be set to “1.”

Table 9-12 Attribute to which “1” is set

attribute	selection_flags to be specified
org_network_id	service_preferred_seleciton_flags
service_id	service_preferred_seleciton_flags

- **number_of_antennas**
The digital satellite broadcasting receiver has one antenna and one input_plug as tuner model. That is, the antenna is not switched.
- **antenna_specification**
Although the external_input_plug_number can be set to any value between 0x80 and 0x9E, it is recommended that 0x9E be used. As connection between external antenna input_plug of the digital satellite broadcasting receiver (unit) and antenna_destination_plug of the Tuner Subunit is specified by the Tuner Identifier Descriptor and the DIRECT SELECT INFORMATION TYPE command (hereinafter referred to as the “DSIT command”), the digital satellite broadcasting receiver does not support CONNECT control command specified by AV/C general that directs the connection between external_antenna_input_plug of the unit and antenna_destination_plug of the Tuner Subunit, and returns “NOT IMPLEMENTED” as the Response.
- **transport**
In the case of digital satellite broadcasting, transport is specified by AV/C Tuner and shall be a value shown in Table 9-13.

Table 9-13 transport

Value	Meaning
001	Digital satellite broadcasting

- system_specific_info
System_specific_info provides DVB_specification_version specified by Enhancements Tuner DVB. system_specific_info shall be a value shown in Table 9-14.

Table 9-14 system_specific_info

Item	Value
system_specific_info	0x11

(2) Tuner Status Descriptor

The Tuner Status Descriptor has the structure shown in Table 9-15. The basic structure is specified by AV/C Tuner.

Table 9-15 Tuner Status Descriptor

(Structure in the case of antenna input (input = 0))

Structure	Number of bits	Value (Note 1)
descriptor_length	16	
general_tuner_status{		
antenna_input_info_length	8	0x0C
antenna_input_info{		
active_system	8	0x20
searching, moving, no_RF, reserved(5bit)	8	
input = 0, selected_antenna(7bit)	8	
antenna_general_system_info{		
BER	32	[0x00000000]
signal_strength	8	[0xFF]
raster_frequency(2bit)	2	0x2
RF_frequency(22bit)	22	[0x000000]
manufacturer_dependent_info_length	8	0x00
}		
}		
system_specific_multiplex_selection_length	8	0x11
system_specific_multiplex_selection{		
system_specific_multiplex_attributes_valid_flags{		
reserved_field, polarization, orbital_position, RF_freq_Raster, symbol_rate, FEC_outer, FEC_inner, modulation	8	[0x00]
network_id, reserved(7bit)	8	[0x00]
}		
system_specific_multiplex_selection_attributes{		
currently_available, selected, reserved(6bit)	8	
polarization(2bit), west_east, reserved(5bit)	8	[0x00]
orbital_position_upper	8	[0x00]
orbital_position_lower	8	[0x00]
raster_frequency	2	0x2
RF_frequency	22	[0x000000]
symbol_rate, reserved(4bit)	20 4	[0x00000] 0x0
FEC_outer	8	[0x00]
FEC_inner	8	[0x00]

Structure	Number of bits	Value (Note 1)
modulation, reserved(3bit)	8	[0x00]
network_id	16	[0x0000]
}		
}		
demux_input_info_length	8	
demux_input_info{		
}		
number_of_source_plugs	8	
for (i = 0; i < number_of_source_plugs; i ++) {		
source_plug_status[i]{		
source_plug	8	
attributes	8	0x00
input, reserved(7bit)	8	0x00
data_status_length	8	0x00
data_status{		
info_type_status_length	8	
info_type_status{		
status	8	
number_of_selection_specifications	8	
for (j = 0; j < number_of_selection_specifications; j ++) {		
dsit_selection_specification[j]{		
specification_length	8	
information_type	8	0x83
system_specific_service_attributes_valid_flags{		
reserved_fields, CA_output, org_network,		
transport_id, service_id, bouquet_id,	8	[0x28]
reserved(2bit)		
}		
}		
system_specific_service_selection_attributes{		
currently_available, reserved(7bit)	8	
CA_output, reserved(7bit)	8	0x00
org_network_id	16	
transport_stream_id	16	[0x0000]
service_id	16	
bouquet_id	16	[0x0000]
}		
}		
}		
}		
}		
number_of_components	8	
for (k = 0; k < number_of_components; k ++) {		
system_specific_component_attributes[k]{		
system_specific_component_attributes_valid_flags{		
reserved_fields, PID, stream_content,		
component_type, iso_639_lang_code,	8	[0x04]
component_tag, reserved(2bit)		
}		
system_specific_component_selection_attributes{		
currently_available, reserved(7bit)	8	
reserved	8	[0x00]
component_tag	8	
}		
}		

Structure	Number of bits	Value (Note 1)
}		
}		
}		
}		
}		
}		
}		

Note 1: Describing the value in a field in which a fixed value is inserted in the Tuner Status Descriptor and that in a field in which a value can be set optionally, but in which the default value is specified (the default value being indicated in []). For the following fields with explanations, also see the corresponding explanation.

- active_system_id**
active_system_id field is set to the value of the system_id that corresponds to the broadcasting system being received. For the setting value of the active_system_id, see system_id of the Tuner Subunit Identifier Descriptor.
- searching, moving, no_RF**
The functions of the flags for searching, moving, no_RF are shown in Table 9-16. Note that the value of no_RF (state) reflects the locked state of the front end of the digital satellite broadcasting receiver, and becomes no_RF = 1 in the unlocked state. Moreover, even when the digital satellite broadcasting receiver is not operating, the value is set as no_RF = 1.

Table 9-16 Indication flag of antenna_input_info

Flag	Meaning of flag
searching	In operation of channel selection = 1
moving	Always “0” (satellite receiving antenna of the fixed type)
no_RF	No antenna signal input (including when the satellite is out of service) = 1

- antenna_input_info**
antenna_input_info shall exist when antenna destination plug is connected.
antenna_input_info shall not exist when antenna destination plug is not connected (antenna_input_info_length = 0x00). The each field in system_specific_multiplex_selection must be invalid.
- selected_antenna**
selected_antenna shall be the index value for antenna_specification of a connected antenna specified by the Tuner Subunit Identifier Descriptor. As only one antenna_specification is generally defined, selected_antenna = 0x00.

- antenna_general_system_info
Each field of antenna_general_system_info is optional and, fields that are not set must be specified using the default values shown in Table 9-17. (The default value must basically be the optimal value that can be set for each field.) The receiver that uses these fields may set and output the value. When the “searching” or “no_RF” is set to “1,” each field of antenna_general_system_info shall be invalid.

Table 9-17 antenna_general_system_info

antenna_general_system_info	Default value	Description
BER (bit error rate)	0x00000000	The default value in the left column or a correct value should be set.
signal_strength	0xFF	The default value in the left column or a correct value should be set.
{raster_frequency (2bits), RF_frequency (22bits)}	0x800000	The default value in the left column or a correct value should be set. However, raster_freq. = 0x2(4 KHz) must be fixed (see the following description of raster_frequency).
manufacturer_dependent_info_length	0x00	manufacturer_dependent_info must not be used.

- raster_frequency
In the indication of the received frequency in antenna_general_input_info and system_specific_multiplex_selection_attributes of the Tuner Status Descriptor, it shall be assumed that raster_frequency = 0x2 (4 KHz). The received frequency is shown by (RF_frequency) * (raster_frequency) (Hz).
- system_specific_multiplex/service_attributes_valid_flags
The bit of system_specific_multiplex/service_attributes_valid_flags that corresponds to the attribute specified as “1” in multiplex/service_preferred_selection_flags of the Tuner Subunit Identifier Descriptor shall be set to “1” (valid). Further except for the attribute that is specified as “1” by multiplex/service_preferred_selection_flags of the Tuner Subunit Identifier Descriptor, for an attribute that the receiver can optionally support (that is, that can be used as an attribute of channel selection of the DSIT command), the bit of system_specific_multiplex/service_attributes_valid_flags that corresponds is set to “1” (valid). Other flags are set to “0.” By checking these flags, the controller can determine which attribute the receiver can accept using the DSIT command.
- system_specific_component_attributes_valid_flags
system_specific_component_attributes of the Tuner Status Descriptor indicates information on components (Elementary Stream (hereinafter referred to as “ES”)) being output from source_plug. Note that it is mandatory that the attributes used for display include component_tag. The receiver that supports information_type of service with specified components, and that supports component (ES) selection specified by the PID using the DSIT command, can use PID in status indication for the DSIT command specified by the PID.
- system_specific_multiplex/service/component_selection_attributes
This indicates a status of the receiver with respect to an attribute that is specified as “1” in multiplex/service_preferred_selection_flags of the Tuner Subunit Identifier Descriptor, and an attribute that the receiver can support using the DSIT command. An attribute for which system_specific_multiplex/service/component_selection_attributes_valid_flags is specified as “0” must be invalid.
- currently_available, selected
currently_available in system_specific_multiplex_selection_attributes normally indicates the same information as that of no_RF of antenna_input_info. However, it is also possible that currently_available is set “0” to indicate a state different from a status of no_RF, in cases in which the Tuner Subunit is in a state in which it is incapable of selecting channel normally

(for example, when the receiver is locked so that channel cannot be changed freely, etc.). In system_specific_service_selection_attributes, currently_available to “0” is set when a corresponding service is out of service, has not yet been contracted and so on. In Table 9-18, examples of the reasons (meanings) for which currently_available in selection_attributes is set to “0” are shown.

Table 9-18 Example of setting currently_available flag

currently_available	Meaning (example)
multiplex_selection_attributes	In a state in which the transponder is stopped and normal channel selection is not executable
service_selection_attributes	Service is stopped or has not yet been contracted.
component_selection_attributes	The corresponding component (ES) cannot be output.

selected is always set to “1.”

- demux_input_info
Table 9-19 shows the structure of demux_input_info when multiplex is being received on the demux destination plug (input = 1). When there is no input from demux_destination_plug, demux_input_info does not exist (demux_input_info_length = 0x00).

Table 9-19 Structure of demux_input_info

Structure	Number of bits	Value (Note 1)
demux_input_info{		
active_system	8	0x20
searching, reserved(7bit)	8	
input = 1, reserved(7bit)	8	0x80
}		

Note 1: The fixed value to be set in the Tuner Status Descriptor must be described. For fields with an explanation, see the corresponding description.

- input
input bit of source_plug_status indicates input = 0 when the input is from antenna destination plug, and set input = 1 when the input is from demux destination plug.
- data_status
data_status field must not be used. data_status_length is always “0.”
- status
In the status field, a value shown in Table 9-20 is set in accordance with the output state of source_plug.

Table 9-20 Meaning of status

status	Meaning
0x00	Neither a service nor a component (ES) is being output to source_plug.
0x10	All specified services and components (ESs) are being output.
0x20	Some of the specified services and components (ESs) are being output.

- **number_of_selection_specifications**
When digital satellite broadcast service receives no signal, `number_of_selection_specifications` is set to 0x00 and the value of status field in `info_type_status` is also set to 0x00. Further, `no_RF` of `antenna_input_info` is set to 1 and `currently_available` of `system_specific_multiplex_selection` is set to 0. For example, when the digital satellite broadcasting receiver is not in operation but the receiver is receiving a broadcast service other than the digital satellite broadcast services, `number_of_selection_specifications` is set according to the above description.

When it can be judged that the service is stopped in some condition, `number_of_selection_specification` can be set to 0x00 and the value of status immediately before it can be set to 0x00.

- **information_type**
In the `information_type` field, a value in Table 9-21 must be set.

Table 9-21 Meaning of `information_type`

<code>information_type</code>	Meaning
0x83	The information contained in the component (ES) (<code>system_specific_component_attributes</code>) is indicated.

- **CA_output**
CA_output is always “0” in the Tuner Status Descriptor.

9.1.5.1.2 Descriptor of the digital terrestrial television broadcasting receiver

The digital terrestrial television broadcasting receiver in accordance with Profile 1 of Enhancements Tuner DVB should support two descriptors in Table 9-22 specified in AV/C General, AV/C Descriptor and AV/C Tuner.

For details of Tuner Subunit Identifier Descriptor, see the AV/C Descriptor and AV/C Tuner.

For details of Tuner Status Descriptor, see the AV/C Tuner.

Table 9-22 Mandatory descriptors

Descriptor	<code>descriptor_type</code>	Description	Support
Tuner Subunit Identifier Descriptor	0x00	Indicates the ability/features of Tuner Subunit	Mandatory
Tuner Status Descriptor	0x80	Indicates the status of Tuner Subunit	Mandatory

Each descriptor structure is as shown below.

(1) Tuner Subunit Identifier Descriptor

The structure of Tuner Subunit Identifier Descriptor is as shown in Table 9-23. The basic structure of Tuner Subunit Identifier Descriptor is specified in AV/C Descriptor and the structure of `subunit_dependent_information` is specified in the AV/C Tuner.

Table 9-23 Tuner Subunit Identifier Descriptor

Structure	Bit Number	Value ^(Note 1)
descriptor_length	16	
generation_ID	8	0x02
size_of_list_ID	8	0x02
size_of_object_ID	8	0x06
size_of_object_position	8	0x02
number_of_root_object_lists	16	[0x0000]
subunit_dependent_length	16	
subunit_dependent_information{		
number_of_systems	8	
for (i=0; i< number_of_systems; i++) {		
system[i]_specification {		
specification_length	16	
system_id	8	0x20
implementation_profile_id	8	0x10
number_of_subsystem_labels	8	
for (j=0; j< number_of_subsystem_labels; j++) {		
subsystem_label_length	8	0x09
subsystem_label[1-9]	72	JPNTB7FFF
}		
multiplex_preferred_selection_flags	16	0x0000
service_preferred_selection_flags	8	0x2C
number_of_antennas	8	[0x01]
for (k=0; k< number_of_antennas; k++) {		
antenna[k]_specification {		
mobile, movable, reserved(3bits), transport(3bits)	8	0x03
external_input_plug_number	8	[0x9D]
system_specific_antenna_range_specification_length	16	0x0007
system_specific_antenna_range_specification		
selection_attribute_range_specification_for_A{		
list_flag, range_flag, size_of_attribute(s)	8	0x00
}		
selection_attribute_range_specification_for_B{		
list_flag, range_flag, size_of_attribute(s)	8	0x00
}		
selection_attribute_range_specification_for_C{		
list_flag, range_flag, size_of_attribute(s)	8	0x00
}		
selection_attribute_range_specification_for_D{		
list_flag, range_flag, size_of_attribute(s)	8	0x00
}		
selection_attribute_range_specification_for_E{		
list_flag, range_flag, size_of_attribute(s)	8	0x00
}		
selection_attribute_range_specification_for_F{		
list_flag, range_flag, size_of_attribute(s)	8	0x00
}		
selection_attribute_range_specification_for_G{		
list_flag, range_flag, size_of_attribute(s)	8	0x00
}		
}		
}		
}		

system_specific_info_length	8	0x01
system_specific_info{		
DVB_specification_version	8	0x11
}		
}		
}		
}		
manufacturer_dependent_length	16	0x0000

Note1: Describe the value to set in Tuner Subunit Identifier Descriptor for the field in which fixed value is inserted and the field in which default value is specified while optional value can be set (default value is indicated in []). For the fields explained below, refer to the corresponding explanation.

- generation_ID
The generation_ID is specified in the AV/C Descriptor and the value should be as shown in Table 9-24.

Table 9-24 generation_ID

Value	Meaning
0x02	Descriptor structure in accordance with AV/C Descriptor(AV/C Descriptor Mechanism Specification Version 1.0)

- size_of_list_ID, size_of_object_position
The size_of_list_ID and size_of_object_position is specified in the AV/C Tuner, and each value should be as shown in Table 9-25.

Table 9-25 size_of_list_ID and size_of_object_position

Item	Value
size_of_list_ID	0x02
size_of_object_position	0x02

- size_of_object_ID
The size_of_object_ID is decided by the restriction of service object ID (6 bytes) specified in Tuner DVB, and the value should be as shown in Table 9-26.

Table 9-26 size_of_object_ID

Item	Value
size_of_object_ID	0x06

- number_of_root_object_lists
Normally, Number_of_root_object_lists is 0x0000, because basically, it does not have the object list in Profile1. When it has the object list optionally, or when it has the object list in Profile other than Profile1, the number of root object list should be the value of this field.
- system_id
The system_id is specified in AV/C Tuner, and the value should be as shown in Table 9-27.

Table 9-27 system_id

Value	Meaning
0x20	Broadcasting system in accordance with DVB

- **implementation_profile_id**
The implementation_profile_id indicating Profile1 is specified in the Enhancements Tuner DVB, and the value should be as shown in Table 9-28.

Table 9-28 implementation_profile_id

Value	Meaning
0x10	Profile1:The Simplest Tuner without Lists and Selection by DSIT

- **number_of_subsystem_labels**
For the digital terrestrial television broadcasting receiver in accordance with DVB, number_of_subsystem_labels is 1.
For the receiver corresponding to BS digital broadcasting in addition to digital terrestrial television broadcasting, add 1 which is the number of network of BS digital broadcasting to the value 1 which is the number of network of digital terrestrial television broadcasting when setting the value. For the receiver unit corresponding also to broadband CS digital broadcasting, add the value of number of network of CS digital broadcasting to the number of network of digital terrestrial television broadcasting to set the value.
For plural digital broadcasting receiver corresponding to both broadcasting of BS digital and CS in addition to digital terrestrial television broadcasting, add the number of network of corresponding BS digital broadcasting and broadband CS digital broadcasting to the number of network of digital terrestrial television broadcasting when setting the value.
- **subsystem_label**
For the means to discriminate (notice) the broadcasting service which the digital terrestrial television broadcasting receiver can receive, it lists all receivable services by discriminating digital terrestrial television broadcasting and satellite digital broadcasting (such as BS digital and broadband CS digital broadcasting) in accordance with DVB.
The subsystem_label sets the label value corresponding one by one to network_id of the receivable broadcasting service by fixing the label length to 9 characters. Usable characters are alphanumeric of ASCII code. The digital terrestrial television broadcasting should be subsystem_label="JPNTB7FFF" (BS digital broadcasting should be set to "JPNBS0004" and broadband CS digital broadcasting should be "JPNCSxxxx" (xxxx represents network_id of the broadband CS digital broadcasting (see ARIB technical documents))).
When the controller reads subsystem_label, it should be considered that the receiver is corresponding to multiple systems and subsystems, and it is corresponding to extension more than Profile1 (for example supporting the List, etc.)
- **multiplex/service_preferred_selection_flags**
In correspondence to individual receivable broadcasting service listed in subsystem_label, set "1" to the bit corresponding to minimum necessary attribute for the receiver to tune.
For the digital terrestrial television broadcasting receiver, support tuning by combining 4-digit number of org_network_id, service_id and org_network_id and set "1" to at least 3 attributes in Table 9-29 .
For the digital terrestrial television broadcasting receiver, use bouquet_id attribute to show that tuning in 4-digit number is possible and set "1" to this attribute.

Table 9-29 attribute to set "1"

attribute	selection_flags to be designated
org_network_id	service_preferred_selection_flags
service_id	service_preferred_selection_flags
bouquet_id Note 2	service_preferred_selection_flags

Note 2: Name of this field should be retained as bouquet_id defined in AV/C Tuner for convenience.

- **number_of_antennas**
For the digital terrestrial television broadcasting receiver, it is handled as an AV/C model having one antenna and input_plug. That is, antenna switching is not made.
- **antenna_specification**
Though values from 0x80 to 0x9E can be set to external_input_plug_number, it is recommended for the digital terrestrial television broadcasting receiver to use 0x9D. (In the case of the BS digital/broadband CS broadcasting receiver, it is recommended to use 0x9E as external_input_plug_number).
As the connection of external_antenna_input_plug of the unit and antenna_destination_plug of the Tuner Subunit is denoted in the Tuner Subunit Identifier Descriptor and the DIRECT SELECT INFORMATION TYPE command (hereinafter DSIT command) for the AV/C model comprising the digital terrestrial television broadcasting receiver, the “AV/C general CONNECT control” command which indicates the connection of the input_plug of the unit and the antenna_destination_plug of the Tuner Subunit is not supported, and the digital terrestrial television broadcasting receiver returns "NOT IMPLEMENTED" as a response.
- **Transport**
In the case of digital terrestrial television broadcasting, “transport” is specified in the AV/C Tuner and the value is as shown in Table 9-30.

Table 9–30 transport

Value	Meaning
011	Terrestrial broadcasting

- **system_specific_info**
The DVB_specification_version specified in the Enhancements Tuner DVB is described in the system_specific_info.
The value of the system_specific_info is as shown in Table 9-31.

Table 9-31 system_specific_info

Item	Value
system_specific_info	0x11

(2) Tuner Status Descriptor

The Tuner Status Descriptor for the digital terrestrial television broadcasting receiver is structured as shown in Table 9-32. The basic structure is specified in the AV/C Tuner.

Table 9-32 Tuner Status Descriptor

(Structure in the case of antenna input (input=0))

Structure	Bit Number	Value (Note 1)
descriptor_length	16	
general_tuner_status{		
antenna_input_info_length	8	0x0C
antenna_input_info{		
active_system_id	8	0x20
searching, moving, no_RF, reserved(5bits)	8	
input(=0), selected_antenna(7bits)	8	
antenna_general_system_info{		
BER	32	[0x00000000]
signal_strength	8	[0xFF]
raster_frequency(2bits)	2	0x2
RF_frequency(22bits)	22	[0x000000]

manufacturer_dependent_info_length	8	0x00
}		
}		
system_specific_multiplex_selection_length	8	0x0C
system_specific_multiplex_selection{		
system_specific_multiplex_attributes_valid_flags{		
reserved_field, center_frequency, bandwidth,	8	[0x00]
constellation, hierarchy_info, code_rate-HP_stream,		
code_rate-LP_stream, guard_interval		
network_id, transmission_mode,	8	[0x00]
other_frequency_flag, reserved(5bits)		
}		
system_specific_multiplex_selection_attributes{		
currently_available, selected, reserved(6bits)	8	
center_frequency	32	[0x00000000]
bandwidth(3bits), reserved(5bits)	8	[0x00]
constellation(2bits), hierarchy_info(3bits),	8	[0x00]
code_rate-HP_stream(3bits)		
code_rate-LP_stream(3bits), guard_interval(2bits),	8	[0x00]
transmission_mode(2bits), other_frequency_flag		
network_id	16	[0x0000]
}		
}		
demux_input_info_length	8	
demux_input_info{ }		
}		
number_of_source_plugs	8	
for (i=0; i< number_of_source_plugs; i++) {		
source_plug_status[i]{		
source_plug_number	8	
attributes	8	0x00
input, reserved(7bits)	8	0x00
data_status_length	8	0x00
data_status{ }		
info_type_status_length	8	
info_type_status{		
status	8	[0x00/10/20]
number_of_selection_specifications	8	
for (j=0; j< number_of_selection_specifications; j++) {		
dsit_selection_specification[j]{		
specification_length	8	
information_type	8	0x83
system_specific_service_attributes_valid_flags{		
reserved_fields, CA_output, org_network,		
transport_id, service_id, bouquet_id,	8	[0x2C]
reserved(2bits)		
}		
system_specific_service_selection_attributes{		
currently_available, reserved(7bits)	8	
CA_output, reserved(7bits)	8	0x00
org_network_id	16	
transport_stream_id	16	[0x0000]
service_id	16	
bouquet_id	16	

<pre> } number_of_components for (k=0; k< number_of_components; k++) { system_specific_component_attributes[k]{ system_specific_component_attributes_valid_flags{ reserved_fields, PID, stream_content, component_type, iso_639_lang_code, component_tag, reserved(2bits) } system_specific_component_selection_attributes{ currently_available, reserved(7bits) reserved component_tag } } } } } } } } } } </pre>	<p>8</p> <p>8</p> <p>8</p> <p>8</p> <p>8</p>	<p>[0x04]</p> <p>[0x00]</p>
---	--	-----------------------------

Note 1: Describes the value for the field in which a fixed value is inserted for the Tuner Status Descriptor and the field in which a default value is specified when the value can be set optionally (default value is indicated in []). For the field explained as follows, refer to the corresponding explanation.

- active_system_id**
 In the active_system_id, set the value of system_id corresponding to the receiving broadcasting system.
 For the set value of active_system_id, see the system_ID of the Tuner Subunit Identifier Descriptor.
- searching, moving, no_RF**
 Functions of each flag of “searching, moving, no_RF” are as shown in Table 9-33.
 The set value of each field of network_id, service_id and bouquet_id while the value of the searching flag is “1” depends on the mounting of the receiver. (The controller shall wait until it becomes searching==0 when reading each field of network_id/service_id/bouquet_id of the Tuner Status Descriptor for the purpose of confirming the tuning controller.)
 The value (status) of no_RF indicates the front end lock status of the digital terrestrial television broadcasting receiver, and when it is unlocked, it is no_RF=1. When the digital terrestrial television broadcasting receiver is not operated, it is also no_RF=1.

Table 9-33 Indication flag of antenna_input_info

Flag	Meaning of the flag
searching	During tuning operation ==1
moving	Always "0" (The digital terrestrial television broadcasting antenna is a fixed type)
no_RF	There is no antenna signal input (including during broadcasting halt)==1

- antenna_input_info
When the antenna destination plug is connected with the external_antenna_input_plug of the unit (input ==0), the antenna_input_info exists. When they are not connected, the antenna_input_info does not exist (antenna_input_info_length==0x00). In this case, each field of system_specific_mux_selection is ineffective.
- selected_antenna
The selected_antenna shall be the index value of the antenna_specification specified in the Tuner Subunit Identifier Descriptor of the connected antenna.
As only one antenna_specification is defined for the digital terrestrial television broadcasting receiver, selected_antenna==0x00.
- antenna_general_system_info
Setting of each field of antenna_general_system_info shall be optional and for the unit in which the value is not set, the default value shall be set as shown in Table 9-34.
When the “searching” or no_RF bit is set to “1”, each field in the antenna_general_system_info is invalid.

Table 9-34 antenna_general_system_info

antenna_general_system_info	Default value	Description
BER (bit error rate)	0x00000000	Set the default value or the correct value in the left column.
signal_strength	0xFF	Set the default value or the correct value in the left column.
{raster_frequency(2bits), RF_frequency(22bits)}	0x800000	Set the default value or the correct value in the left column. However, raster_frequency= 0x2(4KHz) is fixed. (See the explanation of raster_frequency as follows.)
manufacture_dependent_info_length	0x00	The manufacture_dependent_info is not used for the digital terrestrial television broadcasting receiver.

- raster_frequency
Allocation of the raster_frequency field value is specified in the Tuner DVB.
Indication of the receiving frequency of antenna_general_input_info of the Tuner Status Descriptor shall be raster_frequency=4KHz.
The receiving frequency is indicated by (RF_frequency)*(raster_frequency)(Hz).
- system_specific_mux/service_attributes_valid_flags
Set the bit of the system_specific_mux/service_attributes_valid_flags corresponding to the attribute designated for the multiplex/service_preferred_selection_flags of the Tuner Subunit Identifier Descriptor as “1” to “1”(valid). Moreover, attribute other than the multiplex/service_preferred_selection_flags of the Tuner Subunit Identifier Descriptor is designated as “1”, which the receiver can correspond optionally (usable for the attribute of the DSIT command tuning), set the bit corresponding to the system_specific_mux/service_attributes_valid_flags to “1”(valid). Other flags shall be “0”. The controller can notice which attribute the receiver can receive by the DSIT command by confirming the flags mentioned above.
- system_specific_component_attributes_valid_flags
The system_specific_component_attributes of the Tuner Status Descriptor sets the information of the component (Elementary Stream (hereinafter ES)) output from the source_plug. For the attributes used for the setting, component_tag is mandatory and supports information_type of “service with specified components” by the DSIT command. Also, a receiver which supports the selection of component (ES) of PID designation can use the PID by the status indication to the DSIT command of the PID designation.

- **system_specific_mux/service/component_selection_attributes**
It sets the status of the receiver for the attribute which can correspond by the DSIT command for the attribute that is set to “1” with the multiplex/service_preferred_selection_flags of the Tuner Subunit Identifier Descriptor and the receiver.
The attribute in which the system_specific_mux/service/component_attributes_valid_flags is designated as “0” shall be invalid.
- **currently_available, selected**
currently_available: For the system_specific_mux_selection_attributes, the same information as the no_RF of the antenna_input_info (values of “0” and “1” are reversed) is set normally. However, when the Tuner Subunit is in the condition that it cannot operate tuning normally for some reason (ex. the receiver is locked and cannot change the channel freely, etc.), it can be set to “0” to indicate that the condition differs from no_RF.

For system_specific_service_selection_attributes, “0” is set when the corresponding service is suspended or not yet contracted.
Reasons to set “0” to currently_available of each selection_attributes are shown in Table 9-35.

Table 9-35 Examples of currently_available flag setting

currently_available	Meaning (example)
multiplex_selection_attributes	The transponder is suspended and cannot make normal tuning operation.
service_selection_attributes	Service is halted or not yet contracted
component_selection_attributes	Corresponded component(ES) cannot be output

For the digital terrestrial television broadcasting receiver, “selected” shall be always set to “1”.

- **demux_input_info**
The structure when there is input (input=1) from “demux destination plug” is as shown in Table 9-36.
When there is no input from “demux_destination_plug”, there is no demux_input_info. It shall be (demux_input_info_length==0x00).

Table 9-36 Structure of demux_input_info

Structure	Bit Number	Value (Note 2)
demux_input_info{		
active_system	8	0x20
searching, reserved(7bits)	8	
input(=1), reserved(7bits)	8	0x80
}		

Note 2: This describes the value to be set in the field in which the fixed value is inserted with the Tuner Status Descriptor. For the field with explanation, see the corresponding explanation.

- **Input**
For the input bit of source_plug_status, set input=0 when it is input from the antenna destination plug and set input=1 when input from the demux destination plug.
- **data_status**
The field of data_status is not used for the digital terrestrial television broadcasting receiver. The data_status_length is always set to “0”.
- **Status**
The field of status shall be set to the value shown in Table 9-37 according to the output status of the source_plug.

Table 9-37 Meaning of the status

status	Meaning
0x00	No “service, component (ES)” output to the source_plug.
0x10	All the designated “service, component (ES)” is output.
0x20	A part of designated service, component (ES) is output.

- **number_of_selection_specifications**
When there is no input of the digital terrestrial television broadcasting, set the number_of_selection_specifications to 0x00 and set the status value immediately before it also to 0x00. Also, set the no_RF of antenna_input_info to “1” and the currently_available of system_specific_multiplex_selection to “0”. For example, during reception of broadcasting other than digital terrestrial television and when the digital terrestrial television broadcasting receiver is not operated, the setting shall be as shown above. When it can be judged that the service is halted in some condition, the number_of_selection_specification may be set to 0x00 and the status value immediately before it may be set also to 0x00.
- **information_type**
The field of information_type should set the value as shown in Table 9-38.

Table 9-38 Meaning of information_type

inforamtion_type	Meaning
0x83	Information (system_specific_comnponent_attributes) of component(ES) is indicated

- **CA_output**
CA_output of the Tuner Status Descriptor of the digital terrestrial television broadcasting receiver shall always be set to “0”.
- **org_network_id/service_id/bouquet_id**
For org_network_id, set the network_id which indicates the whole digital terrestrial television broadcasting. For service_id, set the service_id which the digital terrestrial television broadcasting receiver finished the tuning operation and which corresponds to the service now tuned. For bouquet_id, set the 4-digit number allocated to the service designated by the above service_id.
For the value which can be set to the service_id and the value which can be set to the bouquet_id, see the ARIB technical documents.

9.1.5.2 AV/C command

9.1.5.2.1 AV/C command of the satellite digital broadcasting receiver

A satellite digital broadcasting receiver in conformity to Profile 1 of Enhancements Tuner DBV shall support following commands. The command can be divided in AV/C General command, AV/C Descriptor command and AV/C Tuner command.

For details on each command, refer to AV/C General, AV/C Descriptor and AV/C Tuner.

(1) AV/C General command

The digital satellite broadcasting receiver must support at least the AV/C General commands given in Table 9-39.

Table 9-39 Indispensable AV/C general commands

Opcode	Value	Command Type	Description	Support
UNIT INFO	0x30	STATUS	–	Mandatory
SUBUNIT INFO	0x31	STATUS	–	Mandatory
POWER	0xB2	CONTROL/ STATUS	Power-supply control (CONTROL).Status (STATUS)	Mandatory (Note 1)

Note 1: When the digital satellite broadcasting receiver is a stand-alone tuner, support for the power command for the unit is mandatory and support of the power command for the tuner subunit is optional. When it is not a stand-alone tuner, the support of the subunit power command for the tuner subunit is mandatory.

When the satellite digital broadcasting receiver is a stand-alone tuner and it also supports the POWER command to the Tuner Subunit, the same internal operation should be made either to the POWER command to the Unit or to the POWER command to the Tuner Subunit and the same condition should be shown after transition.

The stand-alone tuner receiver unit in the above case is a device having an input/output function (source/destination plug) excluding Tuner Subunit and without including subunit. When plural Tuner Subunits are mounted, it is excluded from the scope of the stand-alone tuner receiver in this guideline.

Notice that for the controllers in case of the satellite digital broadcasting receiver unit (multiple reception device) other than the above, the POWER command to the unit may be supported in some cases but not supported in other cases.

(2) AV/C Descriptor command

The satellite digital broadcasting receiver unit supports the AV/C Descriptor command in Table 9-40.

Table 9-40 Mandatory AV/C Descriptor command

Opcode	Value	Command Type	Description	Support
OPEN DESCRIPTOR	0x08	CONTEOL	Gains and opens the access to rights of the Descriptor	Mandatory (note 1)
OPEN DESCRIPTOR	0x08	STATUS	Investigates and accesses the condition of the Descriptor	Mandatory
READ DESCRIPTOR	0x09	CONTROL	Reads the data from the Descriptor	Mandatory

Note 1: The OPEN DESCRIPTOR command only supports read_open subfunction (0x01) and close subfunction (0x00).

(3) AV/C Tuner command

The digital satellite broadcasting receiver shall support the AV/C Tuner command given in Table 9-41.

Table 9-41 Indispensable AV/C Tuner command

Opcode	Value	COMMAND TYPE	Description	Support
DIRECT SELECT INFORMATION TYPE (DSIT)	0xC8	CONTROL	Channel selection (however, the replace subfunction is mandatory)	Complete service is mandatory.

For a DIRECT SELECT INFORMATION TYPE command, it is mandatory that subfunction supports replace (0xD2), and that information_type supports “selecting a complete service” (0x82).

1) DIRECT SELECT INFORMATION TYPE command

The DIRECT SELECT INFORMATION TYPE command is specified by AV/C Tuner. Table 9-42 shows the structure of the DSIT command. This table shows an example that information_type is “service with specified components (optional, 0x83).” In the case of complete service, the structure is the same except for a point at which the fields of number_of_components and the following fields do not exist, and a point at which information_type differs (0x82).

Table 9-42 DIRECT SELECT INFORMATION TYPE command

(A case of service with specified components (information_type = 0x83))

Structure	Number of bits	Value (Note 1)
DIRECT SELECT INFORMATION TYPE	8	0xC8
source_plug	8	
subfunction	8	[0xD2]
status	8	0xFF
system_id	8	0x20
input, antenna_number(7bits)	8	
system_specific_search_flags{		
orb_pos, main_freq_up, main_freq_down, service_id, reserved(4bits)	8	[0x00]
}		
system_specific_multiplex_selection_length	8	0x11
system_specific_multiplex_selection{		
system_specific_multiplex_attributes_valid_flags{		
reserved_field, pol, orb_pos, RF_raster symbol_rate, FEC_outer, FEC_inner, modulation	8	[0x00]
network_id, reserved(7bits)	8	[0x00]
system_specific_multiplex_selection_attributes{		
currently_available, selected, reserved(6bits)	8	0x00
polarization(2bits), west_east, reserved(5bits)	8	[0x0] [0x00]
orbital_position_upper	8	[0x00]
orbital_position_lower	8	[0x00]
raster_frequency(2bits), RF_frequency(22bits)	24	0x2 [0x000000]
symbol_rate, reserved(4bits)	24	[0x000000]
FEC_outer	8	[0x00]
FEC_inner	8	[0x00]
modulation, reserved(3bits)	8	[0x00]
network_id	16	[0x0000]
}		
number_of_dsit_selection_specifications	8	
dsit_selection_specification [0]{	8	
specification_length	8	
information_type	8	
system_specific_service_attributes_valid_flags{		
reserved_fields, CA_output, org_network, transport_id, service_id, bouquet_id, reserved(2bits)	8	[0x28]
}		
system_specific_service_selection_attributes{		
currently_available, reserved(7bits)	8	0x00
CA_output, reserved(7bits)	8	0x00
org_network_id	16	
transport_stream_id	16	[0x0000]
service_id	16	
bouquet_id	16	[0x0000]
}		
number_of_components	8	

Structure	Number of bits	Value (Note 1)
for (i = 0; i < number_of_components; i++) {		
system_specific_component_attributes[i]{		
system_specific_component_attributes_valid_flags{		
reserved_fields, PID, stream_content, component_type, iso_639_lang_code, component_tag, reserved(2bits)	8	[0x04]
}		
system_specific_component_selection_attributes{		
currently_available, reserved(7bits)	8	0x00
reserved	8	[0x00]
component_tag	8	
}		
}		
}		

Note 1: Describing a value for a field in which a fixed value is inserted by the DSIT command and for a field in which a value can be set optionally, but in which the default value is specified (the default value being indicated in []). For the following fields with explanations, also see the corresponding explanation.

- **source_plug**
This field indicates the source plug number that outputs a service for which the Tuner Subunit select.
- **subfunction**
Only the function of replace (subfunction = 0xD2) shall be supported. Other subfunction(clear, remove, append, new) is optional.
- **input**
When input from an antenna destination plug is selected, input value is set to '0'; when input from the demux destination plug is selected, input value is set to '1'.
- **antenna_number**
When input = 0, antenna_number shall be an index value of antenna_spec of a connected antenna that is specified by Tuner Subunit Identifier Descriptor. Normally, only one antenna_spec is defined: antenna_number = 0x00. When input = 1, antenna_number field has no meaning, and it is assumed that antenna_number = 0x00.
- **system_specific_search_flags**
Regarding system_specific_multiplex/service_selection_attributes corresponding to a flag that was set to "1," the search operation is started from a set value. For the digital satellite broadcasting receiver, the only search option of "service_id" is optional and in this case, the value of the system_specific_search_flag is 0x10. Note that, regarding the search direction, the receiver shall search only in a direction such that the value of "search_id" specified by system_specific_selection_attributes is increased.

- **information_type**
Complete service(information_type = 0x82) is mandatory. Service with specified components(information_type = 0x83) is optional. In cases in which the digital satellite broadcasting receiver does not support service with specified components, when the controller executes the DSIT command of service with specified components, the receiver shall return “NOT IMPLEMENTED” as the response.
- **system_specific_mux/service/component_attributes_valid_flags**
This indicates an attribute in which an effective value for channel selection is set in a corresponding system_specific_mux/service/component_selection_attribute. Note that only attributes for which system_specific_mux/service_attributes_valid_flags of the Tuner Status Descriptor were set to “1” are usable. Note also that an attribute with a flag of “0” shall be treated as invalid.
- **currently_available, selected**
Currently_available and selected shall be always “0” in the DSIT command (no meaning).
- **raster_frequency**
In the DSIT command raster_frequency shall be set to 0x2 (4 KHz). A frequency in the DSIT command is indicated by (RF_frequency) * (raster_frequency) (Hz).
- **system_specific_component_selection_attributes**
Selecting a service with specified component (information_type-0x83) is optional. When this option is used, system_specific_component_selection_attributes shall specify component_tag as the default (selection specified by the PID is optional).

All components required in the tuning shall be specified.

system_specific_component_selection_attributes must be repeated for the number specified with number_of_components.

2) DIRECT SELECT INFORMATION TYPE: command response

- response code

When a “NOT IMPLEMENTED” response is returned, a response including the unmodified opcode and operand of the DSIT command received from the controller shall be returned.

(Note: The description of the DSIT command of AV/C Tuner is ambiguous.)

INTERIM shall not be used as a response when the DSIT command is received.

The digital satellite broadcasting receiver can perform a normal tuning operation only when it receives the DSIT command from the controller where both org_network_id and service_id are properly received.

If an unsupported org_network_id is specified by the DSIT command, tuning operation is not performed. If the receiver is able to determine that an org_network_id is not supported within 100 msec, it returns a “NOT IMPLEMENTED” response. If the receiver cannot determine within 100 msec, it may return an “ACCEPTED” response whether the support is available or not, without waiting until the end of the tuning operation. However, the receiver should ideally be designed to be able to make the necessary assessment within 100 msec.

When the “ACCEPTED” response is returned, without waiting until the end of the tuning operation, to the DSIT command from the controller, the status_field in the next column should be set to “0x01” and the searching of the Tuner Status Descriptor should be set to “1” immediately, and set it to “0” when the tuning is finished.

Some digital satellite broadcasting receivers may be unable to perform the tuning operation because an invalid service_id is specified, for example, even though the receiver returned an “ACCEPTED” response to the DSIT command. Therefore, to determine with certainty whether the target has completed an assigned operation, it is necessary for the controller to verify not only the currently_available flag but also org_network_id and service_id.

- status

The relationship between a response to the DSIT command from the controller and the controller’s subsequent expected operation is shown in Table 9-43.

Table 9-43 DSIT command response

Status of receiver at the time of receiving the DSIT command	Response code	Status field in response frame	Operation of controller
Tuning according to the DSIT command	ACCEPTED	0x00	
Tuning with some parameters being assessed by receiver	ACCEPTED	0x01	If confirmation of tuning status is necessary, controller confirms Tuner Status Descriptor. (Note 2)
Returned “ACCEPTED” before tuning is completed	ACCEPTED	0x01	If confirmation of tuning status is necessary, controller confirms Tuner Status Descriptor. (Note 2)
Unable to tune	REJECTED	0xFF	
The DSIT command is not supported	NOT IMPLEMENTED	0xFF	

Note 2: The controller confirms the Tuner Status Descriptor through the following operating procedure:

1. The controller waits until the Tuner Status descriptor’s search status reaches “searching = 0.” Also, the controller repeats confirmation until the searching bit becomes “0.”

2. The controller confirms the status field and information_type within the info_type_status area of the Tuner Status Descriptor. The status and information_type in the Tuner Status Descriptor indicate output states to source_plug. For definitions of these states, see Table 9-20 and Table 9-21 in section 9.1.5.1.1 (2), “Tuner Status Descriptor.”

9.1.5.2.2 AV/C command for digital terrestrial television broadcasting receiver

The digital terrestrial television broadcasting receiver in accordance with Profile 1 of Enhancements Tuner DVB shall support the following commands. The command is divided into AV/C General command, AV/C Descriptor command and AV/C Tuner command.

For details of each command, refer to the AV/C General, AV/C Descriptor and AV/C Tuner.

(1) AV/C General command

The digital terrestrial television broadcasting receiver should at least support the AV/C General command in Table 9-44.

Table 9-44 Mandatory AV/C General command

Opcode	VALUE	COMMAND TYPE	Description	SUPPORT
UNIT INFO	0x30	STATUS	-	Mandatory
SUBUNIT INFO	0x31	STATUS	-	Mandatory
POWER	0xB2	CONTROL/ STATUS	Power control (CONTROL)/ Status (STATUS)	Mandatory (Note 1)

Note 1: When the digital terrestrial television broadcasting receiver is a tuner unit, support for the POWER command to the unit is mandatory, and support for the POWER command to the tuner subunit is optional. When it is not a tuner unit receiver, support for the POWER command to the tuner subunit is mandatory.

When the tuner unit digital terrestrial television broadcasting receiver also supports the POWER command to the tuner subunit, internal operation shall be the same for the POWER command to the unit and the POWER command to the tuner subunit, and the status shall also be the same after the transition.

The tuner unit receiver in the above case means a unit not including subunit having I/O function (source/destination_plug) other than tuner subunit, and when multiple tuner subunits are mounted, it is excluded from the tuner unit receiver in this guide line.

In the case of controller for the digital terrestrial television broadcasting receiver (multiple receivers) other than mentioned above, care should be taken as the POWER command for the unit is supported in some cases and not supported in other cases.

(2) AV/C Descriptor command

The digital terrestrial television broadcasting receiver shall support the AV/C Descriptor command in Table 9-45.

Table 9-45 Mandatory AV/C Descriptor command

Opcode	Value	Command Type	Description	Support
OPEN DESCRIPTOR	0x08	CONTROL	Gains and opens the access rights of the Descriptor	Mandatory (Note 1)
OPEN DESCRIPTOR	0x08	STATUS	Investigates the access condition of the Descriptor	Mandatory
READ DESCRIPTOR	0x09	CONTROL	Reads the data from the Descriptor	Mandatory

Note 1: The OPEN DESCRIPTOR command only supports read_open subfunction(0x01) and close subfunction(0x00).

(3) AV/C Tuner command

The digital terrestrial television broadcasting receiver supports the AV/C Tuner command in Table 9-46.

Table 9-46 Mandatory AV/C Tuner command

Opcode	VALUE	COMMAND TYPE	Descriptor	Support
DIRECT SELECT INFORMATION TYPE (DSIT)	0xC8	CONTROL	Tuning (However, replace subfunction is mandatory.)	Complete service is mandatory

For DIRECT SELECT INFORMATION TYPE command, it is mandatory for the subfunction to support replace (0xD2) and for the information_type to support selecting a complete service” (0x82)

1) DIRECT SELECT INFORMATION TYPE command

The DIRECT SELECT INFORMATION TYPE command is specified in AV/C Tuner.

The DSIT command structure is shown in Table 9-47. Example when information_type is “service with specified” components (optional, 0x83) is shown here. In the case of “complete service”, the structure is the same except that there are no fields following number_of_components and that information_type differs (0x82).

Table 9-47 DIRECT SELECT INFORMATION TYPE command

(In the case of service with specified components (information_type=0x83))

Structure	Bit Number	Value (Note 1)
DIRECT SELECT INFORMATION TYPE	8	0xC8
source_plug	8	
subfunction	8	[0xD2]
status	8	0xFF
system_id	8	0x20
input, antenna_number(7bits)	8	
system_specific_search_flags{ orb_pos, main_freq_up, main_freq_down, service_id, reserved(4bits) }	8	[0x00]
system_specific_multiplex_selection_length	8	0x11
system_specific_multiplex_selection{ system_specific_multiplex_attributes_valid_flags{ reserved_field, center_frequency, bandwidth, constellation, hierarchy_info, code_rate-HP_stream, code_rate-LP_stream, guard_interval network_id, transmission_mode, other_frequency_flag, reserved(5bits) }	8	[0x00]
system_specific_multiplex_selection_attributes{ currently_available, selected, reserved(6bits)	8	0x00
center_frequency	32	[0x00000000]
bandwidth(3bits), reserved(5bits)	8	[0x00]
constellation(2bits), hierarchy_info(3bits), code_rate-HP_stream(3bits)	8	[0x00]
code_rate-LP_stream(3bits), guard_interval(2bits), transmission_mode(2bits), other_frequency_flag	8	[0x00]

network_id	16	[0x0000]
}		
}		
number_of_dsit_selection_specifications	8	
for (i=0; i< number_of_dsit_selection_specifications; i++) {		
dsit_selection_specification [i]{	8	
specification_length	8	
information_type	8	
system_specific_service_attributes_valid_flags{		
reserved_fields, CA_output, org_network, transport_id,	8	[0x28/0x24
service_id, bouquet_id, reserved(2bits)		(/0x2C)]
}		
system_specific_service_selection_attributes{		
currently_available, reserved(7bits)	8	0x00
CA_output, reserved(7bits)	8	0x00
org_network_id	16	
transport_stream_id	16	[0x0000]
service_id	16	
bouquet_id	16	[0x0000]
}		
}		
number_of_components	8	
for (j=0; j< number_of_components; j++) {		
system_specific_component_attributes[j]{		
system_specific_component_attributes_valid_flags{		
reserved_fields, PID, stream_content, component_type,	8	[0x04]
iso_639_lang_code, component_tag, reserved(2bits)		
}		
system_specific_component_selection_attributes{		
currently_available, reserved(7bits)	8	0x00
reserved	8	[0x00]
component_tag	8	
}		
}		
}		
}		

Note 1: Describes the field to set the fixed value with the DSIT command, and the field in which the default value is specified while optional value can be settled (default value is indicated in []). For the field explained as follows, refer also to the corresponding explanation.

- source_plug
Designates the number of source plug by which the service tuned by the Tuner Subunit is output.
- Subfunction
Only replace (subfunction=0xD2) support shall be mandatory. Other subfunction (clear, remove, append, new) shall be optional.
- input
When selecting input from “antenna destination plug”, designate input=0 and when selecting input from “demux destination plug”, designate input=1.
- antenna_number
In the case of input=0, antenna_number is the index value of antenna_spec designated by the Tuner Subunit Identifier Descriptor of the connected antenna. As antenna_spec is the only one defined normally, it shall be antenna_number=0x00. In the case of input=1, antenna_number field has no meaning. It shall be: antenna_number=0x00.

- **system_specific_search_flags**
Searching operation starts from the set value for the system_specific_mux/service_selection_attributes corresponding to the flag that is set to “1”.
For the digital terrestrial television broadcasting receiver, only searching of ”service_id” can be supported optionally, and in this case, the value of system_specific_search_flags is 0x10.
However, for the direction of search, searching should be made only to the increasing direction from the value of ”service_id” specified by system_specific_selection_attributes.
- **information_type**
“Complete service (information_type=0x82)” is mandatory. “Service with specified components (information_type=0x83)” is optional.
When the digital terrestrial television broadcasting receiver does not support “service with specified components”, and when the controller executes the DSIT command of “service with specified components”, the receiver response shall be ”NOT IMPLEMENTED”.
- **system_specific_mux/service/component_attributes_valid_flags**
This indicates the attribute by which the effective value for tuning is set in corresponding system_specific_mux/service/component_selection_attributes. However, the only available attribute is the attribute in which system_specific_mux/service_attributes_valid_flags of the Tuner Status Descriptor is set to “1”.
In the case of digital terrestrial television broadcasting, org_network of system_specific_service_attributes_valid_flags shall be always “1”. The attribute in which the flag is “0” shall be handled as ineffective.
- **currently_available, selected**
In the DSIT command, currently_available, selected should be always “0” (It does not have meaning.)
- **org_network_id/service_id/bouquet_id**
When tuning is required by service_id to the controller, org_network of system_specific_service_selection_attributes_valid_flags and flag of service_id shall be set to “1” and shall set the value of org_network_id and service_id corresponding to the desired service.
For the value of org_network_id (0x7FFF), set the value of org_network_id to indicate the whole digital terrestrial television.
When tuning is requested with 4-digit number, set the flag of org_network_id and bouquet_id of system_specific_service_selection_attributes_valid_flag to “1” and set 4-digit number to org_network_id and bouquet_id corresponding to the desired service. For the values available for bouquet_id setting, see the ARIB technical documents.
For the digital terrestrial television broadcasting receiver, when both service_id and bouquet_id of system_specific_service_selection_attributes_valid_flags are set to “1” and when both attributes of service_id and bouquet_id are set to effective value, tuning operation is made with priority on service_id. When normal tuning operation can not be done with service_id, the mounting condition of the receiver determines whether or not to make tuning operation using bouquet_id.
- **system_specific_component_selection_attributes**
Though “selecting a service with specified component (information_type=0x83)” is optional, when it is designated, designate component_tag with system_specific_component_selection_attributes as a default. (Selection designated by PID shall be optional.)
Designate all components requested by the tuning. Repeat system_specific_component_selection_attributes for the numbers designated with number_of_components.

2) DIRECT SELECT INFORMATION TYPE command response

- Response code

When responding "NOT IMPLEMENTED", respond by applying opcode and operand of DSIT command received from the controller without change. (Note: Notation of DSIT of AV/C Tuner is obscure.) INTERIM should not be used as a response when receiving DSIT command. For the digital terrestrial television broadcasting receiver, when DSIT command is received from the controller, normal tuning operation can be made only when the combination of org_network_id and service_id or bouquet_id (4-digit number) is designated correctly.

If an unsupported org_network_id is specified by the DSIT command, tuning operation is not performed. If the receiver is able to determine that an org_network_id is not supported within 100 msec, it returns a "NOT IMPLEMENTED" response. If the receiver cannot determine within 100 msec, it may return an "ACCEPTED" response regardless of the support or not waiting until the end of the tuning operation. However, the receiver should ideally be designed to be able to make the necessary assessment within 100 msec.

When the "ACCEPTED" response is sent without waiting until the end of the tuning operation to the DSIT command from the controller, the status_field in the next column should be set to "0x01" and the searching of the Tuner Status Descriptor should be set to "1" immediately, and set to "0" when the tuning is finished.

Some digital satellite broadcasting receivers may be unable to perform the tuning operation because an invalid org_network_id, service_id or bouquet_id (4-digit number) is specified, for example, although the receiver returned an "ACCEPTED" response to the DSIT command. Therefore, to determine with certainty whether the target has completed an assigned operation, it is necessary for a controller to verify not only the currently_available flag but also org_network_id and service_id or bouquet_id (4-digit number).

- status

Table 9-48 shows the relation of response from the controller for the DSIT command and operation expected to the controller after the response.

Table 9-48 DSIT command response e

Receiver 's status when receiving DSIT command	Response code	Status field in the response frame	Operation of a controller
Tuning according to DSIT command	ACCEPTED	0x00	-
Receiver judges a part of parameter for tuning	ACCEPTED	0x01	When confirmation of tuning condition is necessary, confirm Tuner Status Descriptor (Note 2)
Returns ACCEPTED before tuning is finished	ACCEPTED	0x01	When confirmation of tuning condition is necessary, confirm Tuner Status Descriptor (Note 2)
Tuning is impossible	REJECTED	0xFF	-
Not supported	NOT IMPLEMENTED	0xFF	-

Note 2: The controller confirms the Tuner Status Descriptor through the following operating procedure:

1. The controller waits until the Tuner Status Descriptor's search status reaches "searching = 0." Also, the controller repeats confirmation until the searching bit becomes "0."
2. The controller confirms the status field and information_type within the info_type_status area of the Tuner Status descriptor. The status and information_type in the Tuner Status descriptor indicate output states to source_plug. For definitions of these states, see Table 9-37 and Table 9-38 in section 9.1.5.1.2 (2), "Tuner Status Descriptor."

9.1.5.3 Tuner model (refers to connection of the demux destination plug)

The Tuner subunit has two input plugs: an antenna destination plug and a demux destination plug. The antenna destination plug is connected to an external (antenna) input plug of the satellite or digital terrestrial television broadcasting receiver (unit), while the demux destination plug can be connected to an external (nonantenna) input plug, a serial bus input plug, or another subunit source plug as necessary.

A connection model for the Tuner subunit is shown in Fig. 9-1.

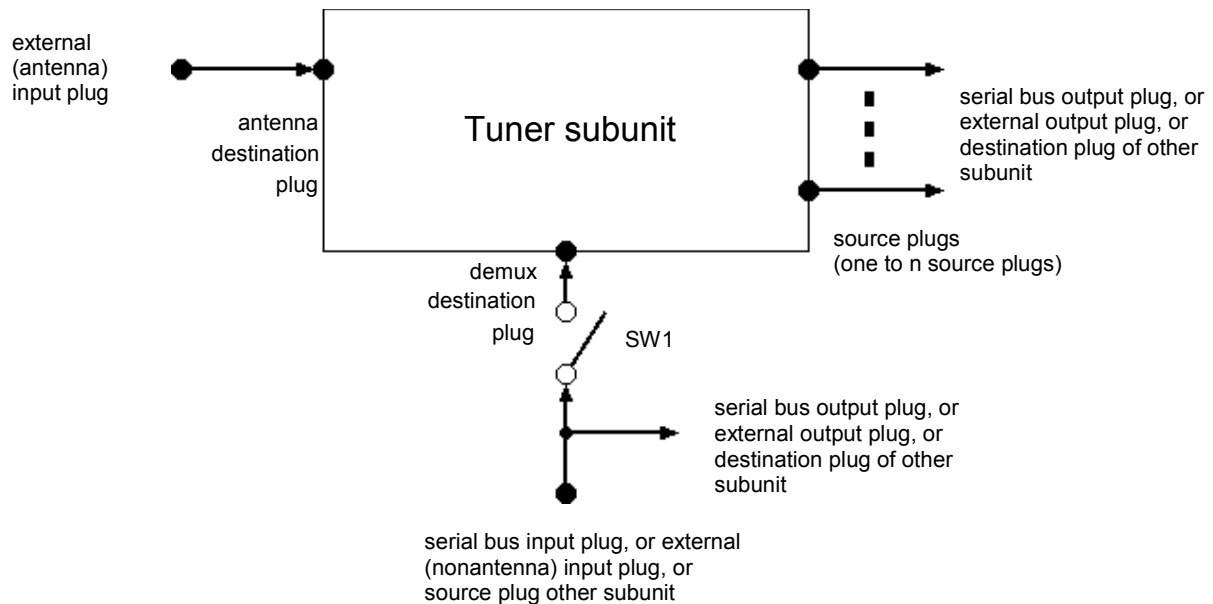

Fig. 9-1 Model of Tuner Subunit

(1) Stream reception from the demux destination plug

A connection between the demux destination plug and plug (external (nonantenna) input plug, or serial bus input plug, or source plug of other subunit) to be able to connect to the demux destination plug can be established only when a selection operation is being operated on a stream received from the latter plug using a demux function specified by the Tuner subunit. (See Fig. 9-1, “Operation of SW1”)

(2) Model connection of Tuner subunit

For an example of a connection model of the satellite or digital terrestrial television broadcasting receiver (unit), see Fig. 9-2, which shows a model with a single built-in Tuner subunit.

The Tuner subunit has two input plugs (the antenna destination plug and the demux destination plug) and one output plug (the source plug). The antenna destination plug is connected to an external (antenna) input plug of the satellite or digital terrestrial television broadcasting receiver, while the demux destination plug can be connected to the serial bus input plug of the satellite or digital terrestrial television broadcasting receiver via SW1. The source plug can be connected to two output plugs (the serial bus output plug and the external output plug (analog output)) of the satellite or digital terrestrial television broadcasting receiver via SW2.

- Operation of SW1
 1. When a selection operation is conducted on the stream being input from the serial bus input plug using the demux function of the Tuner Subunit, SW1 makes a connection (i.e., is ON).
 2. When the demux function of the Tuner subunit is not used for the stream being input from the serial bus input plug (e.g., for reception of a stream containing only one service and hence needing no selection by the demux function), SW1 makes a disconnection (i.e., is OFF).
- Operation of SW2

SW2 selects streams being output from the serial bus output plug and from the external output plug.

 1. When the stream from the Tuner subunit is output, SW2 makes a connection with the Tuner subunit source plug.
 2. When the input stream from the serial bus input plug is output without using the demux function of the Tuner subunit, SW2 makes a connection with the serial bus input plug.
 3. The stream is not necessarily output to the serial bus output plug and the external output plug (analog output) at the same time.

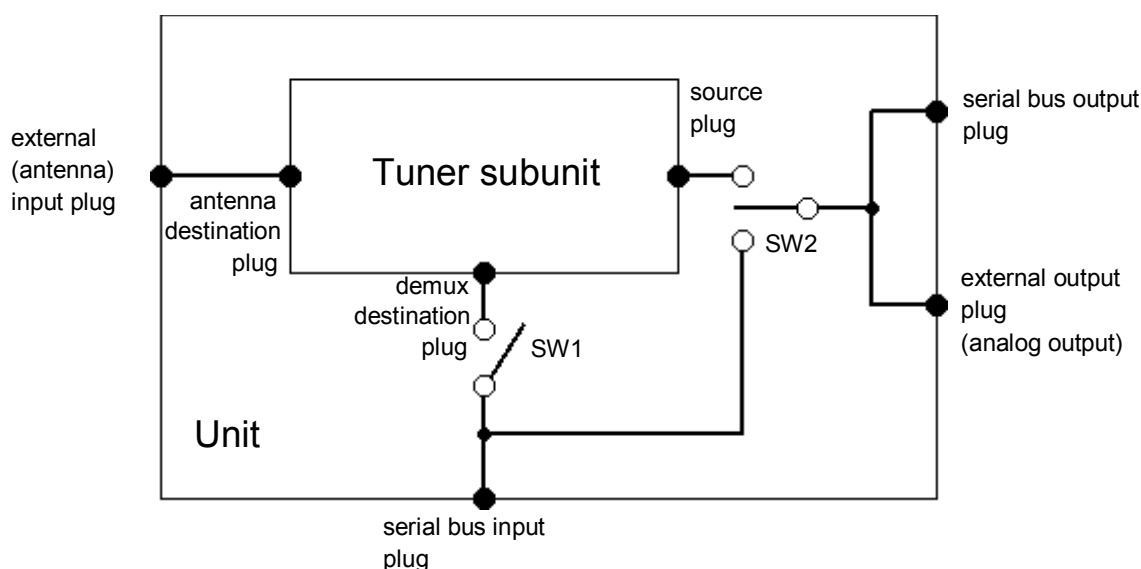

Fig. 9-2 Connection model of Tuner subunit (example)

With the above-mentioned configuration, when, for example, there is no input from the antenna and a signal that does not use the demux function is input from the serial bus input plug, an input flag for `source_plug_status` of the Tuner Status Descriptor is set to 0, `status` is set to 0x00, `number_of_selection_specifications` is set to 0x00, `no_RF` of `antenna_input_info` is set to 1, and `currently_available` of `system_specific_multiplex_selection` is set to 0.

(3) Command when the Tuner subunit is receiving signal from the demux destination plug

When the Tuner subunit of the satellite or digital terrestrial television broadcasting receiver is receiving a stream from the demux destination plug, the Tuner subunit receives the DSIT command from the controller only if the stream is one that the satellite or digital terrestrial television broadcasting receiver can tune normally. In such cases, the DSIT command shall obey the following rules. However, any fields not specified below shall obey the rules of 9.1.5.2. (2) 1).

The DSIT command when the stream received from the demux destination plug is being selected is structured as shown in Table 9-42 for the satellite digital broadcasting receiver unit and as shown in Table 9-47 for the digital terrestrial television broadcasting receiver unit.

- **input**
When selecting the input from the demux destination plug, `input` shall be set to '1'.
- **antenna_number**
When `input` = 1, the `antenna_number` field has no meaning. `antenna_number` shall be set to 0x00.
- **system_specific_multiplex_selection**
When selecting the input from the demux destination plug, all parameters contained in `system_specific_multiplex_selection` have no meaning.

`System_specific_multiplex_selection_attributes_valid_flag` shall always be "0x00."

- **system_specific_service_attributes_valid_flags**
The flags indicate an attribute of `system_specific_service_selection_attributes` where an effective value for the selection is set. However, the attributes that can be used are restricted to those for which the `system_specific_service_attributes_valid_flags` of Tuner Status Descriptor were set to "1," except `org_network_id`. (A flag corresponding to `org_network_id` is assumed to be "0.") Note that any attribute whose flag is "0" shall be invalid.

- `service_id`
 `service_id` corresponds to a service to be selected from among those contained in a stream being input from the demux destination plug.

9.1.6 I/O transport stream of serial interface

For output transport streams of the serial interface, either transport streams before de-max or partial transport streams exist; for the corresponding input transport streams, the situation is the same. The partial transport stream is a bit stream obtained by removing transport packets that do not relate to specially selected one or more service from the transport packets of MPEG-2.

The basic construction of the service information, the operation standard of descriptors, the data structure and definitions of the service information, and the guidelines for table operation procedures that are used in the partial transport stream, shall be as described in sections 9.1.7, 9.1.8, and 9.1.9.

9.1.7 Basic construction of the service information and operation standard of descriptors on the serial interface

9.1.7.1 Types of program arrangement information for the serial interface

(1) Types of tables

Types of tables used for the serial interface shall be as described in Table 9-49.

Table 9-49 Name and function of table

Table name	Outline of function
DIT (Discontinuity Information Table)	Indicates a transition point at which program arrangement information transmitted in a partial transport stream is likely to be discontinuous.
SIT (Selection Information Table)	Indicates information regarding programs that are transmitted in a partial transport stream.

(2) Types of descriptors

Types of descriptors used for the serial interface shall be as described in Table 9-50.

Table 9-50 Name and function of descriptor

Descriptor	Outline of function
Partial Transport Stream Descriptor	Gives description of partial transport stream.
Network Identification Descriptor	Gives description of network identification.
PartialTS Time Descriptor	Gives description of partial transport stream time.

9.1.7.2 Transmission of service information on the serial interface

(1) PID that transmits a table

PID values of the transport stream packet for transmitting a table as specified by Table 9-49 shall be as described in Table 9-51.

Table 9-51 Assignment of PID

PID	Table
0x001E	DIT
0x001F	SIT

(2) Identifier of table and criterion of transmission

The table ID and transmission level of the table specified in Table 9-52 shall be as described in Table 9-49.

Table 9-52 Assignment of table id and criterion for transmission

Table_id	Table	Transmission level	Transmission frequency
0x7E	DIT	Mandatory	Transmits two transport stream packets successively when partial transport stream may be discontinuous.
0x7F	SIT	Mandatory	Conforms to transmission frequency of NIT (once/10 seconds or more).

(3) Identifier of descriptor to be transmitted by SIT and transmission criterion

Tag values for the descriptors transmitted by SIT, descriptors, and level of transmission shall be as described in Table 9-30. For descriptors which can be transmitted by SIT with the satellite digital broadcasting receiver and the digital terrestrial television broadcasting receiver, refer to the ARIB technical documents. For descriptors which are specified in this standard, refer to ARIB STD-B10.

Table 9-53 Tag value of descriptor transmitted by SIT and transmission criterion

Tag value	Descriptor	Transmission level
0x42	staffing_descriptor	Discretionary optional
0x47	bouquet_name_descriptor	Discretionary optional
0x48	service_descriptor	Discretionary optional
0x49	country_availability_description	Discretionary optional
0x4A	linkage_descriptor	Discretionary optional
0x4B	NVOD_reference_descriptor	Discretionary optional
0x4C	time_shifted_service_descriptor	Discretionary optional
0x4D	short_event_descriptor	Discretionary optional
0x4E	extended_event_descriptor	Discretionary optional
0x4F	time_shifted_event_descriptor	Discretionary optional
0x50	component_descriptor	Discretionary optional
0x51	mosaic_descriptor	Discretionary optional
0x53	Ca_identifier_descriptor	Discretionary optional
0x54	content_descriptor	Discretionary optional
0x55	parental_rating_descriptor	Discretionary optional
0x63	partial_transport_stream_descriptor	Mandatory
0xC2	network_identifier_descriptor	Mandatory
0xC3	partialTS_time_descriptor	Discretionary optional
0xC4	audio_component_descriptor	Discretionary optional
0xC5	hyperlink_descriptor	Discretionary optional
0xC7	data_contents_descriptor	Discretionary optional
0xCD	TS_information_descriptor	Discretionary optional
0xCE	extenosn_broadcaster_name_descriptor	Discretionary optional
0xD5	series_descriptor	Discretionary optional
0xD6	event_group_descriptor	Discretionary optional
0xD8	broadcaster_descriptor	Discretionary optional
0xD9	component_group_descriptor	Discretionary optional

9.1.7.3 Data structure of service information on the serial interface

(1) Data structure of table

The tables shown in Table 9-49 shall follow the section format defined by MPEG-2 systems (ITU-H.222.0, ISO/IEC 13818-1), and their data structures are shown in Fig. 9-3 and Fig. 9-4.

The definition of each division of the data structure in the tables is described in ARIB STD-B10, and the condition of usage is defined by this standard.

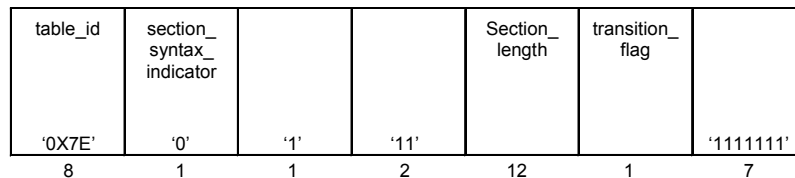

Fig. 9-3 Data structure of DIT

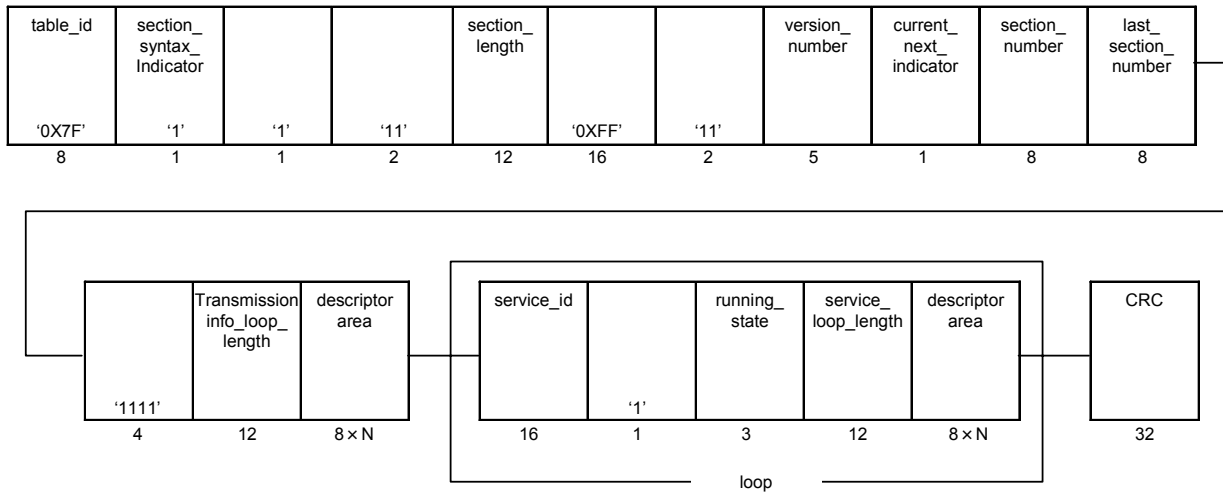

Fig. 9-4 Data structure of SIT

(2) Data structure of descriptor

The partial_transport_stream_descriptor, the network_identifier_descriptor, and the partialTS_time_descriptor shall follow the format defined by MPEG-2 systems (ITU-h.222.0, ISO/IEC 13818-1), and their data structures are shown in Figs. 9-5, 9-6, and 9-7.

The definition for sections of the data structure and usage conditions will be defined separately.

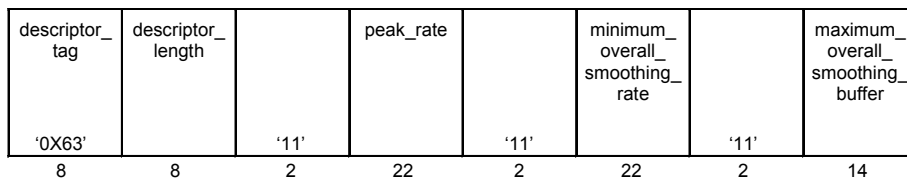

Fig. 9-5 Data structure of partial_transport_stream_descriptor

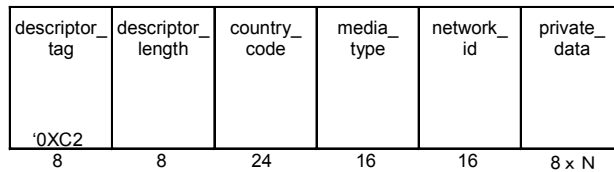

Fig. 9-6 Data structure of network_identifier_descriptor

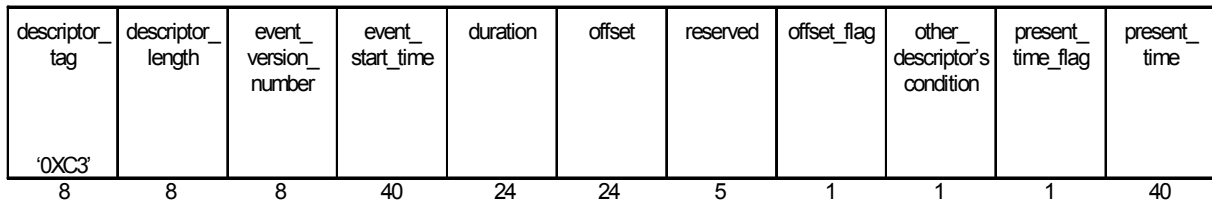

Fig. 9-7 Data structure of partialTS_time_descriptor

9.1.8 Data structure and definition of service information on the serial interface

9.1.8.1 Explanation of service information on the serial interface

This section describes the PSI and SI data required for the partial transport stream on the serial interface.

PSI data shall be restricted to PAT and PMT, which are required in order to represent the stream in the partial transport stream correctly.

The partial transport stream shall not carry any SI tables except SIT and DIT. Moreover, the use of SIT and DIT is restricted to the partial transport stream; these tables shall not be coded directly in broadcasts. (For example, in a case in which the transport stream in which SIT was inserted is transmitted as a data carousel transmission, SIT does not carry on the transport stream directly.)

The presence of SIT in a bit stream flags the bit stream as a partial transport stream coming from the serial interface. In this case, DIRD must not expect the SI information needed in the transport stream of broadcasting; instead, it only use information transmitted by SIT.

(1) Selection information table (SIT)

SIT provides a summary of SI information necessary to provide stream information for the partial transport stream.

(2) Discontinuity information table (DIT)

DIT shall be inserted at transition points at which the SI information of the partial transport stream becomes discontinuous.

9.1.8.2 Service information table on the serial interface

The table used for the serial interface is coded by using a private section syntax defined by ISO/IEC 13818-1. SIT may be up to 4096 bytes long.

The bit stream on the serial interface shall be either a “complete” and “partial” transport stream, with SI conforming to this standard (ARIB STD-B21). For the partial transport stream, SI and PSI shall conform to the following subclauses:

The partial transport stream shall not carry any SI tables other than SIT and DIT described below. The PSI shall be restricted to the PAT and PMT, required to correctly describe the stream in the partial transport stream.

The presence of SIT in the bit stream identifies the bit stream as a partial transport stream coming from the serial interface. In this case, DIRD should not expect the SI information required in the transport stream of broadcasting, and should instead rely on information carried by the SIT.

The SIT contains a summary of all relevant SI information contained in the broadcast stream. The DIT shall be inserted at transition points at which the SI information is discontinuous. The Use of the SIT and DIT is restricted to the partial transport stream; SIT and DIT shall not be used in broadcasts.

(1) Coding of PID and table_id

The PID value of the transport stream packet carried the section of DIT and SIT tables is shown in Table 9-54.

Table 9-54 PID allocation

table	PID value
DIT	0x001E
SIT	0x001F

Table 9-55 shows values used for the table identification that are used for the serial interface defined by this standard.

Table 9-55 table_id allocation

table_id value	table
0x7E	DIT
0x7F	SIT

(2) Definition of table

The following paragraphs describe the data structures and meanings of various tables.

1) Discontinuity Information Table (DIT)

The DIT shall be inserted at a transition point where the SI information becomes discontinuous.

The DIT is composed of a single section that uses the data structure of Table 9-56. This DIT section is carried by a transport stream packet whose PID value is 0x001E, and has a table_id value of 0x7E.

Table 9-56 Discontinuity information section

Data structure	Number of bits	Identifier
Discontinuity_information_section{		
table_id	8	uimsbf
Section_syntax_indicator	1	bslbf
Reserved_future_use	1	bslbf
Reserved	2	bslbf
Section_length	12	uimsbf
Transition_flag	1	uimsbf
Reserved_future_use	7	bslbf
}		

Semantics for the discontinuity information section:

- table_id:** See Table 9-55.
- section_syntax_indicator:** The section syntax indication is a 1-bit field, which shall be set to '0'.
- section_length:** This is a 12-bit field which is set to 0x001.
- transition_flag:** This 1-bit flag indicates the kind of transition in the transport stream. When this bit is set to "1," it indicates the transition is due to a change of the original source. The change of the original source means a change of the original transport stream and/or a change of position in the transport stream (for example, in case of time shift). When this bit is set to "0," it indicates that the transition is due to a change of the selection only, that is, while staying within the same original transport stream at the same position.

2) Selection Information Table (SIT)

The SIT describes the service and an event carried by the partial transport stream.

SIT is divided into selection information sections through the data structure shown in Table 9-57. All sections that constitute part of SIT shall be carried by the transport packet whose PID value shall be 0x001F, and the table_id value shall be 0x7F.

Table 9-57 Selection information section

Data structure	Number of bits	Identifier
selection_information_section(){		
table_id	8	uimsbf
Section_syntax_indicator	1	bslbf
Reserved_future_use	1	bslbf
ISO_reserved	2	bslbf
Section_length	12	uimsbf
Reserved_future_use	16	bslbf
ISO_reserved	2	bslbf
Version_number	5	uimsbf
Current_next_indicator	1	bslbf
Section_number	8	uimsbf
last_section_number	8	uimsbf
Reserved_future_use	4	uimsbf
Transmission_info_loop_length	12	uimsbf
for(i=0;I<N;i++){		
Descriptor()		
}		
for(i=0;I<N;i++){		
Service_id	16	uimsbf
Reserved_future_use	1	uimsbf
Running_status	3	bslbf
Service_loop_length	12	uimsbf
For(j=0;j<N;j++){		
descriptor()		
}		
}		
CRC_32	32	rpchof
}		

Semantics for the selection information section:

table_id: See Table 9-55.

section_syntax_indicator: The section_syntax_indicator is a 1-bit field, which shall be set to '1'.

section_length: This is a 12-bit field. It specifies the number of bytes of the sections, starting immediately following this field and including the CRC. The section_length shall not exceed 4093, so that the entire section has a maximum length of 4096 bytes.

version_number: This 5-bit field is the version number of the table. The version_number shall be increased by 1 when a change in the information carried within the table occurs. When the value reaches 31, it wraps around to 0. When the current_next_indicator is set to "1," then the version_number shall be that of currently applicable table. When the current_next_indicator is set to "0," then the version_number shall be that of the next applicable table.

current_next_indicator:	When this 1-bit indication is set to “1,” it indicates that the table is the currently applicable table. When the bit is set to “0,” it indicates that the table sent is not yet applicable and shall be the next table to be valid.
section_number:	This 8-bit field indicates the number of the section. The section_number shall be 0x00.
last_section_number:	This 8-bit field indicates the number of the last section. The last_section_number shall be 0x00.
transmission_info_loop_length:	This 12-bit field indicates the total length in bytes of the following descriptor loop describing the transmission parameters of the partial transport stream.
service_id:	This is a 16-bit field which serves as a label to identify this service from any other service within a transport stream. service_id is the same as the program_number in the corresponding program_map_section.
running_status:	This 3-bit field indicates the running status of the event in the original stream. This is the running status of the original present event. If no present event exists in the original stream, the status is considered as “not running” inactive. The meaning of the running_state value is as defined in ARIB STD-B10.
service_loop_length:	This 12-bit field gives the total length in bytes of the following descriptor loop containing SI-related information on the service and event contained in the partial transport stream.
CRC_32:	This is a 32-bit field containing the CRC value that gives a zero output of the registers in the decoder defined by Appendix b of ARIB STD-B10 after processing entire section.

9.1.8.3 Descriptor of the serial interface

Here the data structures of the descriptors found only in the partial transport stream will be described. The transmission-information descriptor loop of the selection information table (SIT) contains all the information required for controlling and managing the play-out and copying of partial TS. The descriptors below is proposed to describe this information.

(1) Partial Transport Stream descriptor (Partial_Transport_Stream_descriptor)

This descriptor is used as information required for recording the partial transport stream.
(See Table 9-58)

Table 9-58 Partial Transport Stream descriptor

Data structure	Number of bits	Identifier
partial_transport_stream_descriptor0{		
Descriptor_tag	8	uimsbf
Descriptor_length	8	uimsbf
Reserved_future_use	2	bslbf
peak_rate	22	uimsbf
Reserved_future_use	2	bslbf
Minimum_overall_smoothing_rate	22	uimsbf
Reserved_future_use	2	bslbf
Maximum_overall_smoothing_buffer	14	uimsbf
}		

Semantics for the partial_transport_stream_descriptors:

- peak_rate:** The maximum, momentary transport packet rate (i.e., obtained by 188 bytes dividing by the time interval between start times of two successive transport stream packets). At least, an upper bound for this peak_rate should be given. This 22-bit field is coded as a positive integer in units of 400 bits per second.
- minimum_overall_smoothing_rate:** Minimum smoothing buffer leak rate for the overall transport streams (all packets are covered). This 22-bit field is coded as a positive integer in units of 400 bits per second. A value 0x3FFFFFF is used to indicate that the minimum smoothing rate is undefined.
- maximum_overall_smoothing_buffer:** Maximum smoothing buffer size for overall transport streams (all packets are covered). This 14-bit field is coded as a positive integer in units of 1 byte. A value 0x3FFF is used to indicate that the maximum smoothing buffer size is undefined.

(2) Network_Identifier_descriptor

This descriptor is used to clarify the original network where the partial transport stream was produced. The descriptor is inserted only in the transmission information description loop of SIT. (See Table 9-59.)

Table 9-59 Network identifier descriptor

Data structure	Number of bits	Identifier
network_identifier_descriptor0{ Descriptor_tag Descriptor_length Country_code media_type Network_id for(i=0; i<N; i++){ private_data } }	8 8 24 16 16 8	uimsbf uimsbf bslbf bslbf uimsbf bslbf

Semantics for the network_identifier descriptor:

country_code: This 24-bit field indicates the country name, using a three-character (alphabetic) code defined in ISO3166. If the country name is used in this descriptor, it indicates a country involved in an allocation system whereby the partial transport stream was generated. Each character is coded by 8 bits according to ISO8859-1, and three characters are inserted into a 24-bit field in this order. The three-character code for Japan is “JPN,” which is coded as follows.

“0100 1010 0101 0000 0100 1110”

media_type: In this 16-bit field, two alphabetic characters are inserted indicating media type. If media_type is used in this descriptor, it indicates the media type of the allocation system whereby the partial transport stream is generated. Each character is coded by 8 bits according to ISO8859-1, and the two characters are inserted into a 16-bit field in this order. The media_type is represented as follows:

Value	Meaning
0x4253	BS/broadband CS
0x4353	Narrow-band CS / Advanced narrow-band CS
0x5442	Terrestrial broadcasting

network_id: This is a 16-bit field, in which a value of the network_id of the allocation system whereby the partial transport stream was generated is described. In the original allocation system, this value is described in NIT, and assignment of the field value is designated by Standard Organization.

private_data: This is an 8xN-bit field, which has an individually defined value.

(3) Partial transport stream time descriptor (PartialTS_time_descriptor)

This descriptor gives the event contains time information and the information of the time when the event is transmitted and is described in SIT. When described in transmission_info_loop, only JST_time shall be described; information on the event shall not. When information on the event is described, the descriptor shall be inserted in service_loop. It is undesirable for multiple descriptors to be inserted into SIT. (See Table 9-60.)

Table 9-60 Partial transport stream time descriptor

Data structure	Number of bits	Identifier
PartialTS_time_descriptor(){		
Descriptor_tag	8	uimsbf
Descriptor_length	8	uimsbf
Event_version_number	8	uimsbf
Event_start_time	40	bslbf
Duration	24	uimsbf
Offset	24	bslbf
Reserved	5	bslbf
Offset_flag	1	bslbf
Other_descriptor_status	1	bslbf
JST_time_flag	1	bslbf
if(JST_time_flag == 1){		
JST_time	40	bslbf
}		
}		

Semanties for the partial TS time descriptor:

- event_version_number:** The event_version_number becomes valid when it is inserted into a service loop of SIT, and shall be incremented by 1 when a change on SI information related to the event indicated by the service loop occurs. Note that the event_version_number shall not be renewed simply because JST_time changed. If the stream in which DIT is inserted changes but the event transmitted before and after DIT maintains continuity, it is desirable that the event_version_number which is exsured continuity is transmitted unmodified.
- event_start_time:** Describes the start time of an event. The event_start_time is the same value as start_time, described in EIT. When time information is not used, “all 1” is described in this field.
- Duration:** Describes the duration of an event. Dulation is the same value as for duration, described in EIT. When the time information is not described, “all 1” is described in this field.
- offset:** Offset time. When event_start_time or JST_time exists, the offset time is applied to that time. When offset is 0x000000, the offset is not applied. The notation is the same method as for duration.

offset_flag:	Defines whether the time is advanced/delayed by the offset time.
0:	Indicates that operations are being conducted with the value of offset being added to both event_start_time and JST_time.
1:	Indicates that operations are being conducted with the value of offset being subtracted from both event_start_time and JST_time.
other_descriptor_status:	Describes states other than partialTS_time_descriptor used in SIT.
0:	Other descriptors have not changed.
1:	Other descriptors may have changed.
JST_time_flag:	When this field is set to “1”, it indicates that JST_time field exists after it.
JST_time:	Present time information is described to an accuracy of two seconds or less in JST_time, described in TDT.

9.1.9 Guidelines for operating procedures for tables used in the partial transport stream

Partial transport streams made from the transport stream shall not carry any service information (SI) data other than the selection information table (SIT) described under this standard (ARIB STD-B21). The SIT contains a summary of all service information in the broadcast streams related to the partial transport stream. All relevant MPEG-2 PSI information should be coded to correctly describe the partial MPEG-2 transport stream.

The presence of SIT in the bit stream indicates that the bit stream is a partial bit stream coming from the serial interface. This allows the DIRD to ignore the absence of any mandatory SI tables and use only coded SIT information in the partial transport stream.

In addition to the SIT, a second table called a discontinuous information table (DIT) is defined by this standard (ARIB STD-B21). This table is inserted at transition points where the service information may be discontinuous.

9.1.9.1 Program association table (PAT)

The PAT describes only the selected service. In addition, network_PID reference should take the value of SIT_PID instead of NIT_PID. Any program/service that has not been selected should be removed. The PAT should not violate the MPEG-2 System requirements.

9.1.9.2 Program map table (PMT)

The PMT should not violate the MPEG-2 System requirements.

For selected services, the corresponding PMT section may remain unchanged only if all elementary streams referenced from it are selected and kept unchanged. In case any of the referenced elementary streams of the service is removed or changed, the PMT section should be modified to reflect this.

For non selected services the obsolete PMT sections may remain in the stream only if they are in the same PID as a PMT section of any selected service. In all other cases they should be removed.

Further, if a digital copy control descriptor is contained within the PMT, it shall remain; i.e., it shall not be removed from the PMT.

9.1.9.3 Program arrangement information tables (NIT, SDT, EIT, BAT, RST, TDT, and TOT)

After selection, these tables should be removed.

9.1.9.4 Selection information table (SIT)

The SIT should be packetized in TS packets starting from the beginning of the payload, i.e. in a packet with `payload_unit_start_indicator` in the TS packet header set to “1” and with the `pointer_field` set to “0x00”. Furthermore, it is recommended that the SIT is packetized in a single TS packet (if possible).

The `transmission_info_loop` in SIT should contain the `partial_transport_stream_descriptor`.

The following loop should contain all the `service_ids` of the selected services. The `service_loop` may contain descriptors from the original EIT and SDT.

9.1.9.5 Discontinuity information table (DIT)

At a transition, the bitstream may be discontinuous with respect to any of the SI information (including PAT and PMT). The DIT table shall be inserted at this transition point.

Whenever a partial bitstream discontinuity occurs, two transport packets belonging to PID 0x001E shall be inserted directly at the transition point, with no other packets in between. The first one shall have 184 bytes of adaptation field stuffing with `discontinuity_flag` set to “1” (in order to ensure compliance to MPEG-2 continuity counting constraints for successions of transitions introduced at independent transmission/storage stages). The second of these transport packets shall contain the “DIT” and shall not have such a flag set to “1”.

The basic construction of the service information, the operation standard of descriptors, and the data structure and definitions of the service information in the serial interface, and the guidelines for operating procedures for tables used in the partial transport stream in the serial interface, conform to the following documents: ETSI ETS 300468 “Digital Video Broadcasting (DVB); Specification for Service Information (SI) in DVB Systems”; and ETR211 “Digital Video Broadcasting (DVB); Implementation Guidelines for the Use of MPEG-2 Systems; Guidelines on Implementation and Usage of Service Information.” Both of these documents were prepared by EP-DVB and EBU and issued by ETSI. See the original technical data as necessary.

9.2 IP interface specifications

9.2.1 Physical interface protocol stack specifications

9.2.1.1 Physical interface specifications

(1) 10BASE-T, 100BASE-TX, 1000BASE-T

The 8-pin modular jack (RJ-45) shall be implemented. Pin assignments for the connector are shown in Fig. 11-8 of “11.4.3 Ethernet interface.” See the EIA/TIA standard for a drawing of the connector geometry.

(2) Wireless LAN

Wireless LAN shall conform to the RCR STD-33, ARIB STD-T66, or ARIB STD-T71.

9.2.1.2 Protocol stack specifications

The receivers of digital satellite broadcasting and digital terrestrial broadcasting shall be implemented with a protocol stack that complies with the Digital Media Server (DMS)

specifications given in "7.1 Networking and Connectivity," "7.2 Device Discovery and Control," "7.3 Media Management," and "7.8 Media Transport" of the Digital Living Network Alliance Home Networked Device Interoperability Guidelines Version 1.0 (abbreviated to "DLNA Guidelines 1.0" hereafter).

9.2.2 Content output specifications

9.2.2.1 Content transmission protocol

The content transmission protocol shall be the Hypertext Transfer Protocol (HTTP), the specifications of which shall conform to the DMS specifications given in "7.8 Media Transport" of the DLNA Guidelines 1.0.

9.2.2.2 Packet format

The transmission packet format used when transmitting contents from the receivers of digital satellite broadcasting and digital terrestrial broadcasting is shown in Table 9-61.

Table 9-61 Transmission packet format

Data Structure	Bit Number	Bit String Notation
Content Packet { header { "0x00" user_defined byte_length } for (i=0; i<(Int((byte_length-1)/16)+1)*16; i++){ palyload } }	8 72 32 8	bslbf bslbf uimsbf bslbf

Meaning of transmission packet format:

Content Packet: A transmission packet whose length is an integral multiple of 8 bits. The packet consists of header and payload parts.

header: A 112-bit field corresponding to the header part of the content packet.

"0x00": An 8-bit field whose value is always "0x00."

user_defined: A 72-bit field whose value is defined by the broadcaster.

byte_length: A 32-bit field that defines content length.

palyload: The payload part of the content packet. The content whose length is given by byte_length is stuffed with 0 to 15 bytes to form a 16-byte unit. All the values of stuffing data shall be "0." The length of palyload should be adjusted so that the time required for the receiver to receive the content becomes 0.3 to 2 sec.

The protection of content shall be specified by each broadcaster.

9.2.2.3 Stream format

The transmission stream of the content in the payload of Table 9-61 shall be the partial transport stream described in 9.1.6 of "Chapter 9 Specifications for high-speed digital interfaces."

The transport packets for transmission that constitute the partial transport stream shall be of the TS format with the time stamp described in 8.1.4 of ARIB STD-B24 Vol. 2.

9.2.2.4 MIME type

The MIME type of the stream consisting of the transmission packets of Table 9-61 shall be `application/X-arib-cp;CONTENTFORMAT=<content-mimetype>`

Here, <content-mimetype> describes the MIME type of the content in the payload of Table 9-61.

9.2.3 Tuner description specifications

The tuner description of the receivers of digital satellite broadcasting and digital terrestrial broadcasting shall comply with the DMS specifications given in "7.3 Media Management" of the DLNA Guidelines 1.0. Described below are additional specifications to provide content directory service (CDS) from the information received by the receiver.

* Character code

To use the 8-unit code SI information received by the receiver in the CDS, the character code used for tuner description shall be coded in the UCS transformation format (UTF-8) according to the DLNA Guidelines 1.0.

When placing character data such as SI information in the properties of CDS, the data is first converted to the universal character set (UCS) and then coded in the UTF-8. The Combining character and the decompose form of UCS should be used.

The conversion from 8-unit code data to UCS data shall comply with the definition given in ARIB STD-B24 Vol. 1 Part 2 Appended Specification E "Correspondence to EUC-JP, extension character and DRCS."

* Tuner description method

Each receiver shall have a tuner container, which indicates each tuner of digital satellite broadcasting (BS and broadband CS digital broadcasting) and digital terrestrial broadcasting contained in the receiver.

* Tuner container and channel item

Among the properties of tuner containers and channel items, the properties specific to this standard are defined by using the following name space:

`xmlns:arib="urn:schemas-arib-or-jp:elements-1-0/"`

* Properties of receiver's tuner container

The tuner container shall have the properties listed in Table 9-62. See the ARIB technical documents for the detailed description method of each property.

Table 9-62 Properties of tuner container

Property name	Requirement level	Property type	Description of property
dc:title	Mandatory	String	Indicates the name of each broadcasting system.
arib:objectType	Mandatory	String	The IP-interface-compatible receivers of digital terrestrial broadcasting, BS digital broadcasting, and broadband CS digital broadcasting are denoted as ARIB_TB, ARIB_BS, and ARIB_CS, respectively in single-width characters.

The properties of "dc:" are defined by the Dublin Core Metadata Initiative.

* Properties of receiver's channel item

The name, requirement level, and description of each property of channel item that shall be used in the receivers of digital satellite broadcasting and digital terrestrial broadcasting are listed in Table 9-63. See the ARIB technical documents for the detailed description method of each property.

Table 9-63 Properties of channel item

Property name	Requirement level	Property type	Description of property
arib:objectType	Mandatory	String	The IP-interface-compatible receivers of digital terrestrial broadcasting, BS digital broadcasting, and broadband CS digital broadcasting are denoted as ARIB_TB, ARIB_BS, and ARIB_CS, respectively in single-width characters.
dc:title	Mandatory	String	Indicates the program name.
upnp:genre	Mandatory	String	Indicates the genre to which the program given by dc:title belongs.
upnp:channelName	Mandatory	String	Indicates the name of service (organized channel).
upnp:channelNr	Mandatory	Integer	Indicates the channel number.
upnp:scheduledStartTime	Optional	String	Indicates the start time of program.
upnp:scheduledEndTime	Optional	String	Indicates the end time of program.
dc:description	Optional	String	Provides the description of program.
arib:longDescription	Optional	String	Provides the detailed description of program.
res@resolution	Optional	Pattern string	Indicates the resolution of output content.
upnp:rating	Optional	String	Indicates the age limit of permitted audience.
upnp:icon	Optional	URI	Indicates the URL of the logo for the relevant channel.
upnp:icon@arib:resolution	Optional	Pattern string	Indicates the size of the logo for the relevant channel.
arib:videoComponentType	Optional	Unsigned integer	Indicates the type of video component.
arib:audioComponentType	Optional	Unsigned integer	Indicates the type of audio component.
arib:audioComponentType@qualityIndicator	Optional	Unsigned integer	Indicates the tone quality mode of audio component.
arib:copyControlInfo	Optional	CSV string	Provides information on the control of program recording and output.
arib:dataProgramInfo	Optional	Boolean	Indicates the presence of data broadcasting.
arib:dataProgramInfo@sync	Optional	Boolean	Indicates the program linkage of data broadcasting.
arib:multiViewInfo	Optional	Boolean	Indicates the operation of multi-view television (MVTV).
arib:captionInfo	Optional	Boolean	Indicates the operation of subtitles.
arib:multiESInfo	Optional	Boolean	Indicates the presence of multiple video or audio ESs
arib:caProgramInfo	Optional	Boolean	Indicates whether the program is chargeable or not.

arib:caProgramInfo@price	Optional	CSV string	Indicates the price of charged program (viewing only or recording).
arib:caProgramInfo@available	Optional	Boolean	Indicates the purchase contract of charged program.

The properties of "upnp:" are defined by the UPnP Forum.

9.2.4 Control of content selection

When allowing stream output of contents of digital satellite broadcasting and digital terrestrial broadcasting from receivers, "protocolInfo" defined in "7.3 Media Management" of the DLNA Guidelines 1.0 shall be used for the control of content selection.

The protocolInfo consists of four fields

(<protocol>:'<network>':'<contentFormat>':'<additionalInfo>).

The first field <protocol> denotes the protocol used for content output.

The second field <network> depends on the output protocol and describes "*" (asterisk) in the case of HTTP.

The third field <contentFormat> depends on the output protocol and indicates the format of the content itself in the case of HTTP.

The fourth field <additionalInfo> provides additional information.

When allowing stream output of contents of digital satellite broadcasting and digital terrestrial broadcasting from receivers, the parameters given by ARIB.OR.JP_PN are described in the fourth field of protocolInfo. The ARIB.OR.JP_PN provides the profile (coding system, transmission packet format, and stream format) indicating the output specifications of the relevant content, and provides description in the following format according to the "other-param" specifications of "7.3.11 MM DIDL-Lite protocolInfo values: 4th field" in the DLNA Guidelines 1.0:

ARIB.OR.JP_PN=<arib-pn-value>

Here, <arib-pn-value> describes the profile that indicates the output specifications of the content.

Furthermore, parameters defined in the DLNA Guidelines 1.0 can be added in the fourth field.

For information on the method of this addition, refer to "7.3.11 MM DIDL-Lite protocolInfo values: 4th field" of the DLNA Guidelines 1.0.

When the protocol of stream output is HTTP, protocolInfo is expressed as follows by using ARIB.OR.JP_PN:

```
http-get:*:application/X-arib-cp;CONTENTFORMAT=<content-mimetype>:ARIB.OR.JP_PN=<arib-pn-value>
```

The description of each field shall be as follows according to the protocolInfo defined in "7.3 Media Management" of the DLNA Guidelines 1.0.

First field: describes http-get, which indicates the HTTP of the output protocol.

Second field: describes "*" (asterisk).

Third field: describes the MIME type.

Fourth field: describes ARIB.OR.JP_PN.

When the coding schemes of the relevant content are MPEG2-Video (ISO/IEC 13818-2) and MPEG2-AAC (ISO/IEC 13818-7) that satisfy the constraints of coding parameters described in "Chapter 6 Decoding process of video and audio and output signals," and when the transmission packet and stream format comply with the specifications given in 9.2.2.2 and 9.2.2.3 (TS format with time stamp) of this standard, respectively, ARIB.OR.JP_PN can be described as ARIB.OR.JP_PN=MPEG_TTS_CP.

* Content-Type header field of HTTP header

The MIME type of the Content-Type header field inserted in the HTTP header of HTTP request or response shall be the same as the MIME type used in the third field of protocolInfo:

Content-Type:application/X-arib-cp;CONTENTFORMAT=<content-mimetype>

Chapter 10: Specifications of CA module interface

For a CA module interface, CA interface that conforms to the “ARIB STD-B25” access control method for digital broadcasting should be furnished.

Chapter 11: Specifications of bidirectional communication function

Specifications of the bidirectional communication function for viewing information collection, data broadcasting, and data distribution are as follows. See also ARIB standards “STD-B24” and “STD-B25.”

To receive BS services, the receiver must be provided with a connection terminal for the telephone line and a ground terminal for the telephone line, a portable phone or PHS connection terminal, and also be equipped with a protocol for collecting the viewing information that will be described in 11.2. Further, to achieve the bidirectional communication function, the receiver must be provided with an interface, as described in this chapter.

11.1 Transmission phases in bidirectional communication

Bidirectional communication using a public network/mobile network (hereinafter, “public network, etc.”) can be divided into five transmission phases: 1) the line connecting phase; 2) the link establishing phase; 3) the data transferring phase; 4) the link terminating phase and 5) the line cutting phase.

These phases are shown in Fig. 11-1.

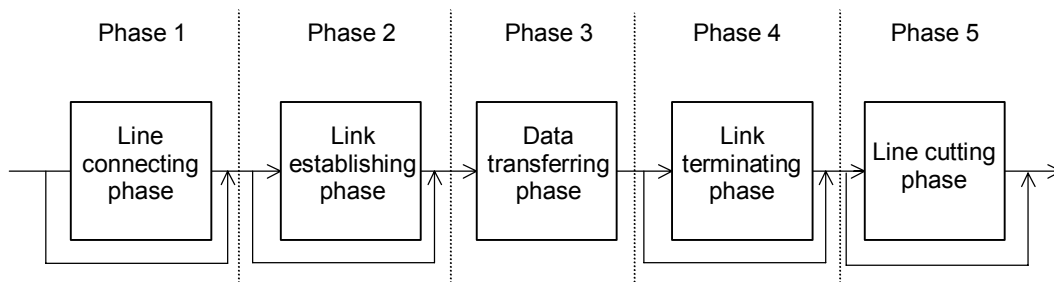

Fig. 11-1 Transmission phases

11.1.1 Line connecting/cutting phase

This is a phase at which DIRD connects/disconnects with a center using the public network, etc. DIRD connects/disconnects the modem, etc. to/from the line using AT commands, etc.

11.1.2 Link establishing/terminating phase

This is a phase at which, after connection of the line, a data transfer link between DIRD and the center is established; or after completion of data transfer, the link between DIRD and the center is terminated. In some cases, this phase is unnecessary, thanks to a special protocol.

11.1.3 Data transfer phase

This is a phase at which data communication is conducted between DIRD and the center according to a specified communication protocol after establishment of the link.

11.2 Viewing information collection protocol

11.2.1 Protocol of link establishing/terminating phase

This is conducted according to a procedure conforming to X.28. (See 11.2.3)

In this phase, a host number at the viewing information collection center is specified.

11.2.2 Protocol of data transferring phase

A protocol stack for the viewing information collection is shown in Table 11-1.

Table 11-1 Protocol stack for viewing information collection

Layer	Protocol stack		
Application layer	Application for viewing information collection		
Data link layer	BASIC system procedure *1, Code-independent mode		
Physical layer	Public network	Portable phone *2	PHS *2
	V.22bis or higher, MNP4 or higher	PDC *3	PIAFS *4

*1 See 11.2.3.

*2 In the physical layer of the portable phone and PHS, a communication method on the DIRD side must be described.

*3 Communication method for digital portable phone (line switching method) (PDC: Personal Digital Cellular). Communication with a center-side modem is accomplish using the same protocol as for a public network.

*4 Data communication method for PHS (PIAFS: PHS Internet Access Forum Standard)

11.2.3 Sequence

Below, connection sequences and data transfer sequences are defined between DIRD and a collection network for a case in which viewing information is collected using a collection network that connects DIRD and the viewing information center.

A viewing information collection system is shown in Fig. 11-2.

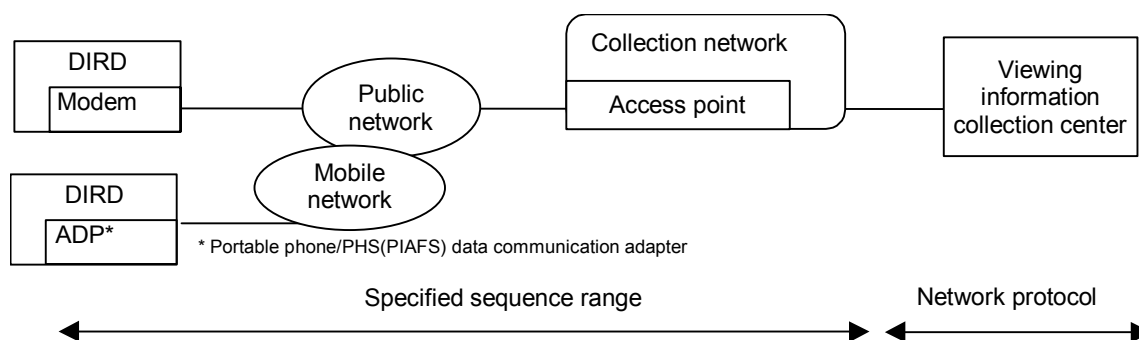

Fig. 11-2 Viewing information collection system

For details of the sequence, see “STD-B25.”

11.3 Data broadcasting service and data distribution protocol

Once the protocol is actually selected, the protocol that best matches the content of an application (e.g., a data broadcast service) must be applied.

The protocol must be equipped with a function that enables alteration of the protocol itself through downloading, etc.

11.3.1 Protocol for link establishing/terminating phase

The protocol stack is shown in Table 11- 2.

Table 11-2 Protocol stack

Layer	Protocol stack
Application layer	Selected according to service
Data link layer	Procedure partially conforming to X.28 (Host number specifying function is necessary.)
Physical layer	See 11.3.2

11.3.2 Protocol of data transfer phase

11.3.2.1 Low-speed modem and communication protocol

A protocol for low-speed modems must be selected from a protocol for text communications, whereby simple text communications can be conducted, and a protocol for binary transfer whereby somewhat more sophisticated communications can be conducted.

The protocol for text communication is shown in Table 11-3; the protocol for binary transfer, in Table 11-4.

Table 11-3 Protocol for text communication

Layer	Protocol stack
Application layer	Selected according to service
Data link layer	Free communication (TTY procedure)
Physical layer	V.22bis or higher, MNP4 or higher

Table 11-4 Communication protocol for binary transfer

Layer	Protocol stack
Application layer	Selected according to service
Data link layer	BASIC procedure (JIS X5002), Code-independent mode
Physical layer	V.22bis or higher, MNP4 or higher

Layer	Protocol stack
Application layer	Selected according to service
Data link layer	HDLC procedure (JIS X5104、 X5105、 X5106)
Physical layer	V.22bis or higher, MNP4 or higher

Layer	Protocol stack
Application layer	Selected according to service
Data link layer	BASIC system procedure* Code-independent mode
Physical layer	V.22bis or higher, MNP4 or higher

* Only the necessary functions are implemented.

Layer	Protocol stack
Application layer	Selected according to service
Data link layer	PPP in HDLC-like Framing (RFC1662)
Physical layer	V.22bis or higher

Layer	Protocol stack
Application layer	HTTP1.0 subset is substituted.
Transport layer	
Network layer	—
Data link layer	—
Physical layer	V.22bis or higher, MNP4 or higher

Note: The need for MNP4 depends on the content of the data broadcast service, etc.

11.3.2.2 Protocol for high-speed modems and communications

A protocol for high-speed modem must be selected from protocols for binary transfer that enable higher-speed communications. In addition, a protocol that was selected for the low-speed modem must be furnished.

Note: In a scheme wherein a high-speed modem is used to receive a service that is provided by the low-speed modem, the high-speed modem must be equipped with a call-out function that features the same modulation method and communication speed as the low-speed modem. This saves negotiation time.

The protocol for text communication is shown in Table 11-5; that for binary transfer, in Table 11-6.

Table 11-5 Protocol for text communication

Layer	Protocol stack
Application layer	Selected according to service
Data link layer	Free communication (TTY procedure)
Physical layer	V.34 or higher, V.42bis

Table 11-6 Communication protocol for binary transfer

Layer	Protocol stack
Application layer	Selected according to service
Data link layer	BASIC procedure (JIS X5002), Code-independent mode
Physical layer	V.34 or higher, V.42bis

Layer	Protocol stack
Application layer	Selected according to service
Data link layer	HDLC procedure (JIS X5104、 X5105、 X5106)
Physical layer	V.34 or higher, V.42bis

Layer	Protocol stack
Application layer	Selected according to service
Data link layer	BASIC system procedure* Code-independent mode
Physical layer	V.34 or higher, V.42bis

* Only the necessary functions are implemented.

Layer	Protocol stack
Application layer	Selected according to service
Data link layer	PPP in HDLC-like Framing (RFC1662)
Physical layer	V.34 or higher, V.42bis

Layer	Protocol stack
Application layer	HTTP1.0 subset is substituted
Transport layer	
Network layer	—
Data link layer	—
Physical layer	V.34 or higher, V.42bis

Layer	Protocol stack
Application layer	Selected from among HTTP1.0(RFC1945), HTTP1.1(RFC2616), Telnet, FTP, NNTP, SMTP, POP3, DNS(RFC1123) etc. according to service.
Transport layer	TCP(RFC793) , UDP(RFC768)
Network layer	IP(RFC791)/ICMP(RFC792)
Data link layer	PPP(RFC1661, 1662)/IPCP(RFC1332) PAP(RFC1334)/CHAP(RFC1994), PPP Internet Protocol Control Protocol Extensions for Name Server Addresses(RFC1877) CCP(RFC1962)
Physical layer	V.34 or higher, V.42bis

11.3.2.3 Communication protocol for ISDN

(1) ISDN-DSU-TA connection

The protocol stack for ISDN-DSU-TA connection is shown in Table 11-7.

Table 11-7 Protocol stack for ISDN-DSU-TA connection

Channel type	B channel	D channel	
Layer	Protocol stack	Protocol stack	
Application layer	Selected from among HTTP1.0(RFC1945), HTTP1.1(RFC2616), Telnet, FTP, NNTP, SMTP, POP3, DNS(RFC1123) etc. according to service	Selected according to service	
Transport layer	TCP(RFC793) , UDP(RFC768)		
Network layer	IP(RFC791)/ICMP(RFC792)	TTC JT-Q.931	X.25 (packet level) (*1)
Data link layer	PPP(RFC1661,1662)/PCP(RFC1332) PAP(RFC1334)/CHAP(RFC1994), PPP Internet Protocol Control Protocol Extensions for Name Server Addresses(RFC1877) CCP(RFC1962)	TTC JT-Q.931	
Physical layer (*2)	RS-232C USB		

*1: Being used in a Dch packet call-control phase.

*2: This must be the same standard as that for the physical interface implemented in TA.

(2) ISDN-DSU-(with built-in TA) connection

The protocol stack for ISDN-DSU (with built-in TA) connection is shown in Table 11-8.

Table 11-8 Protocol stack for ISDN-DSU (with built-in TA)

Channel type	B channel	D channel	
Layer	Protocol stack	Protocol stack	
Application layer	Selected from among HTTP1.0(RFC1945), HTTP1.1(RFC2616), Telnet, FTP, NNTP, SMTP, POP3, DNS(RFC1123) etc. according to service	Selected according to service	
Transport layer	TCP(RFC793) , UDP(RFC768)		
Network layer	IP(RFC791)/ICMP(RFC792)	TTC JT-Q.931	X.25 (packet level) (*1)
Data link layer	PPP(RFC1661,1662)/IPCP(RFC1332) PAP(RFC1334)/CHAP(RFC1994), PPP Internet Protocol Control Protocol Extensions for Name Server Addresses(RFC1877) CCP(RFC1962)	TTC JT-Q.931	
Physical layer (*2)	TTC JT-I.430		

*1: To be used in the DCH packet call-control phase.

11.3.2.4 Ethernet communication protocol

This applies in any case in which ISDN, ADSL, FTTH, and/or CATV is used as a return line.

(1) Direct connection with network terminating set

The protocol stack for a direct connection with a network terminating set is shown in Table 11-9.

Table 11-9 Protocol stack for direct connection with a network terminating set

Layer	Protocol stack
Application layer	Selected from among HTTP1.0(RFC1945), HTTP1.1(RFC2616), Telnet, FTP, NNTP, SMTP, POP3, DNS(RFC1123) , DHCP, etc. according to service.
Transport layer	TCP(RFC793) , UDP(RFC768)
Network layer	IP(RFC791)/ICMP(RFC792)
Data link layer	PPP(RFC1661,1662)/PPPoE(RFC2516) /IPCP(RFC1332) (* 1) PAP(RFC1334)/CHAP(RFC1994), PPP Internet Protocol Control Protocol Extensions for Name Server Addresses(RFC1877) IEEE802.2/ARP(RFC826) CCP(RFC1962)
Physical layer	IEEE802.3

*1: For “always on” connection services, PPP/PPPoE/IPCP must be used.

(2) Router connection

The protocol stack when establishing a router connection is shown in Table 11-10.

Table 11-10 Protocol stack when establishing a router connection

Layer	Protocol stack
Application layer	Selected from among HTTP1.0(RFC1945), HTTP1.1(RFC2616), Telnet, FTP, NNTP, SMTP, POP3, DNS(RFC1123), DHCP, etc. according to service.
Transport layer	TCP(RFC793) , UDP(RFC768)
Network layer	IP(RFC791)/ICMP(RFC792)
Data link layer	IEEE802.2/ARP(RFC826)
Physical layer (*1)	IEEE802.3 (*2) IEEE802.11 (*3)

*1: This layer must have the same standard as that for the physical interface furnished to a dial-up router.

*2: 10BASE-T, 100BASE-TX

*3: Wireless LAN

11.3.2.5 Data communication protocol for use of portable phone/PHS(PIAFS)

This data communication protocol must be selected from among two: a text communication protocol, allowing use of the data communication functions for portable telephones and for PHS(PIAFS); and a binary transfer communications protocol.

The text communication protocol is shown in Table 11-11 and the binary transfer communications protocol, in Table 11-12.

Table 11-11 Protocol for text communication

Layer	Protocol stack	
Application layer	Select according to service	
Data link layer	Free transmission (TTY procedure)	
Physical layer *1	Portable phone	PHS
	PDC	PIAFS

Table 11-12 Communication protocol for binary transfer

Layer	Protocol stack	
Application layer	Selected according to service	
Data link layer	BASIC procedure (JIS X5002), Code-independent mode	
Physical layer *1	Portable phone	PHS
	PDC	PIAFS

Layer	Protocol stack	
Application layer	Selected according to service	
Data link layer	HDLC procedure (JIS X5104, X5105, X5106)	
Physical layer *1	Portable phone	PHS
	PDC	PIAFS

Layer	Protocol stack	
Application layer	Selected according to service	
Data link layer	BASIC system procedure *2 Code-independent mode	
Physical layer *1	Portable phone	PHS
	PDC	PIAFS

Layer	Protocol stack	
Application layer	Selected according to service	
Data link layer	PPP in HDLC-like Framing (RFC1662)	
Physical layer *1	Portable phone	PHS
	PDC	PIAFS

Layer	Protocol stack	
Application layer	HTTP 1.0 subset is substituted	
Transport layer		
Network layer	—	
Data link layer	—	
Physical layer *1	Portable phone	PHS
	PDC	PIAFS

Layer	Protocol stack		
Application layer	Selected from among HTTP1.0(RFC1945), HTTP1.1(RFC2616), Telnet, FTP, NNTP, SMTP, POP3, DNS(RFC1123), etc. according to service.		
Transport layer	TCP(RFC793) , UDP(RFC768)		
Network layer	IP(RFC791)/ICMP(RFC792)		
Data link layer	PPP(RFC1661, 1662)/IPCP(RFC1332) PAP(RFC1334)/CHAP(RFC1994), PPP Internet Protocol Control Protocol Extensions for Name Server Addresses(RFC1877) LCP Extensions(RFC1570) CCP(RFC1962)		
Physical layer *1	Portable phone		PHS
	PDC CDMA Cellular System	PDC-P etc. *3 CDMA Cellular System	DS CDMA, MC CDMA PIAFS

*1 The physical layer must describe a communication method on the DIRD side.

In some cases, communications between a portable phone (PDC)/PHS(PIAFS) and the center may be converted to analog form either in a mobile network or at the center.

*2 Only necessary functions are implemented for the BASIC system procedure.

*3 Packet exchange method for portable phone

11.4 Interfaces

11.4.1 Subscriber telephone line (PSTN) interface

DIRD must be equipped with the jack unit shown in Fig. 11-3 for the connection with the subscriber telephone line.

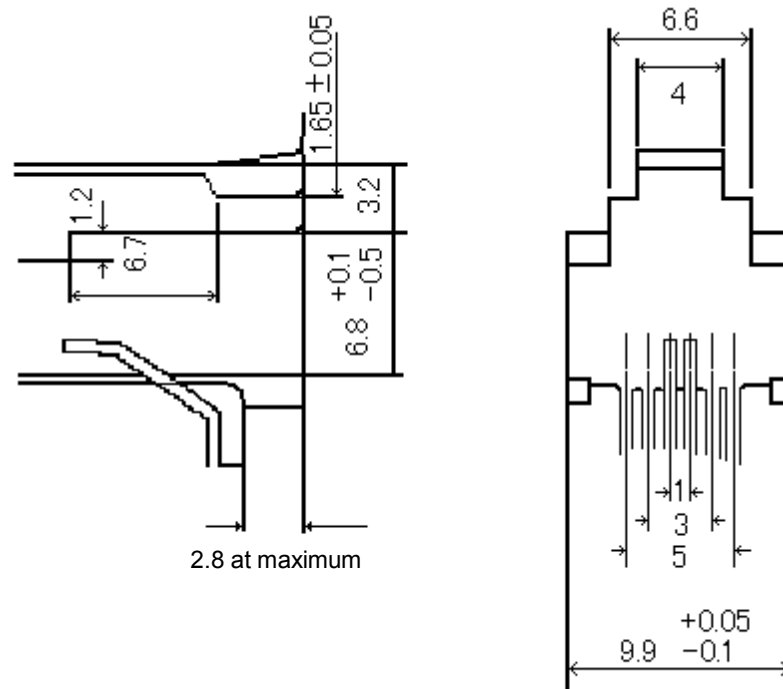

(unit: mm)

Note (1): The contact spring shape is shown as an example.

Note (2): The contact spring has up to 6 leads, which are not necessarily required if the contact spring is not mounted.

Fig. 11-3 Jack unit (notification of the Ministry of Posts and Telecommunications, No. 399)

11.4.1.1 Technical standard to connect with the public network

The technology must conform to JATE.

11.4.1.2 Dialing function

The modem must support the dialing modes DP10/DP20/PB.

11.4.1.3 PBX support function

The modem must be capable of transmitting 0-9, #, * as discrete numbers.

11.4.1.4 Message display function

DIRD must be able to display a message urging the viewer to establish a connection with the subscriber telephone line, if the subscriber telephone line is not connected at the time that viewing information is collected and an outgoing call cannot be made.

11.4.2 ISDN interface

11.4.2.1 Jack unit

An interface that faces DSU or TA must be furnished.

(1) EIA/TIA-232-E (RS-232C)

A D-sub25 pin must be furnished.

Pin assignments for the connector are shown in Fig. 11-4.

For a connector configuration drawing, see the EIA/TIA standard.

Pin number	JIS code	Common use code	Signal
1	—	FG	
2	SD	TxD	Data transmitted
3	RD	RxD	Data received
4	RS	RTS	Request to send
5	CS	CTS	Ready for sending
6	DR	DSR	Other end of communication line ready
7	SG	GND	Ground
8	CD	DCD	Carrier signal
15	ST2		Transmitted signal element timing (DCE)
17	RT		Received signal element timing (DCE)
20	ER	DTR	Terminal ready
22	CI	RI	Ring indicator (call-in display)
24	ST1		Transmitted signal element timing (DTE)

Fig. 11-4 Pin assignment (RS-232c)

(2) USB (ver. 1.0 or higher)

A Series A plug must be furnished.

A drawing of connector geometry is shown in Fig. 11-5, and pin assignments for the connector are shown in Fig. 11-6.

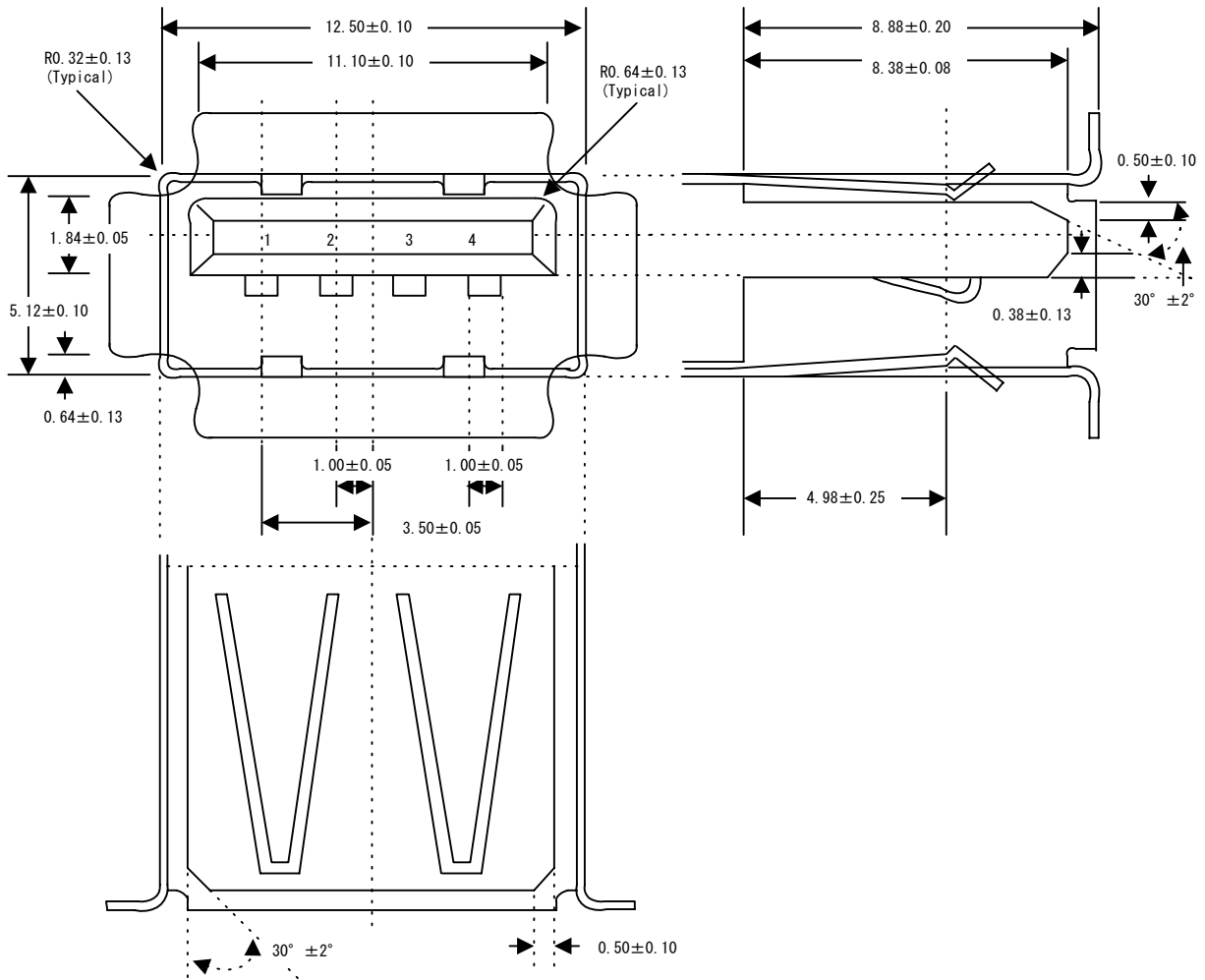

Fig. 11-5 Connector geometry (USB)

Pin number	Signal name
1	Vcc
2	-D
3	+D
4	Ground

Fig. 11-6 Pin assignment (USB)

(3) S/T point

An 8-pin modular jack (RJ-45) must be furnished.

Pin assignments for the connector are shown in Fig. 11-7.

For a drawing of connector geometry, see EIA/TIA standard.

Pin number	Terminal name	Function	Polarity	DSU terminal name
		TE side		
1	a	–	+	
2	b	–	–	
3	c	Transmission	+	TA
4	f	Reception	+	RA
5	e	Reception	–	RB
6	d	Transmission	–	TB
7	g	–		
8	h	–		

Fig. 11-7 Pin assignment (RJ-45)

11.4.3 Ethernet interface

(1) 10BASE-T, 100BASE-TX

The 8-pin modular jack (RJ-45) must be furnished.

Pin assignments for the connector are shown in Fig. 11-8.

For a drawing of the connector geometry, see the EIA/TIA standard.

Pin number	MDI signal
1	TD+
2	TD-
3	RD+
4	Unused
5	Unused
6	RD-
7	Unused
8	Unused

Fig. 11-8 Pin assignment (RJ-45)

(2) Wireless LAN

Wireless LAN must conform to ARIB RCR-STD-33 or RCR-STD-T66.

11.4.4 Portable phone/PHS(PIAFS) interface

A portable phone/PHS(PIAFS) interface must be furnished.

11.4.4.1 Interface standard

Standard	PC Card Standard
	EIA/TIA-232-E(RS-232C)

11.4.4.2 DIRD functions required when the portable phone/PHS(PIAFS) interface is installed

- (1) A function urging the viewer to establish a connection with the portable phone/PHS(PIAFS) if a lack of such connection hampers call out when viewing information is collected.
- (2) A function allowing selection of a common telephone line or a portable phone/PHS(PIAFS) line
- (3) A function for controlling common carrier identification number according to the line to be used.
- (4) A function for installing driver software of a data communication adapter for the portable phone/PHS(PIAFS).

(For example: a function enabling downloading of driver software using broadcast waves or a telephone line)

11.5 Necessary functions for bidirectional communication with use of TCP/IP

11.5.1 Automatic connecting function

For connection modes where ISP connection is achieved through dial-up, connection should desirably be established automatically in accordance with the setting information for the receiver described in 11.5.7, as necessary.

11.5.2 Automatic disconnecting function

For connection modes where ISP connection is achieved through dial-up, the connection should desirably be cut automatically when no packet transmission and/or reception have occurred within a certain time (in accordance with the setting information for the receiver described in 11.5.7), as necessary.

11.5.3 Setting function for viewer-set information elements

A user interface should desirably be furnished whereby the viewer-set information element can be set, altered, or deleted.

11.5.4 Communication security function

- (1) TLS1.0(RFC2246) should desirably be used for security during bidirectional communication.
- (2) A public key issued by the certificate authority (CA) must be maintained.
- (3) The “Route CA certificate” needed for TLS1.0 must be maintained.
- (4) A means for updating the “route CA certificate” must be available.
- (5) The algorithm set used in TLS1.0 must be an operational stipulation.

11.5.5 Presenting function

The following presentation should desirably be provided during bidirectional communication.

- (1) When the line connection is established, a message to that effect must be displayed together with a connected station.
- (2) During the line connection, a display that can be recognized by the viewer (LED, OSD, etc. on the front panel) must be provided.
- (3) When an error occurs, an LED display must be activated.

11.5.6 Line cutting function

The receiver should be able to cut the line explicitly while the line is in use.

11.5.7 Maintaining information elements for bidirectional connection

The following information elements should desirably be maintained in a non-volatile memory in the receiver based on the line-connecting means installed in the receiver.

11.5.7.1 Viewer-set information

- (1) Common information

The content of common information is shown in Table 11-13.

Table 11-13 Common information

Information element	Entity who sets	Content	Value
Postal code	Viewer	Postal code at the location of receiving set	7-digit character string
Priority use line type	Viewer	Line type that viewer selected	- PSTN - ISDN - PHS [PIAFS2.0/PIAFS2.1] - Portable phone [PDC/CDMACelluarSystem/DS-CDMA/MC-CDMA] - Ethernet
Common carrier identification	Viewer	Used for selecting common carriers.	Up-to 7-digit character string
Fixed priority connection cancel number	Viewer	Must be added in case where fixed priority connection is temporarily invalidated	- 122 addition - No addition
Sender's number notification number	Viewer	Used for selecting to notify/not notify sender's telephone number.	- 184 addition - 186 addition - No addition
Outside line acquisition number	Viewer	Number to acquire outside line when being housed in PBX etc.	Up-to 4-digit character string
Dial type	Viewer	Dial type of telephone line	- DP10 pps - DP20 pps - PB

(2) TCP/IP-related information

1) ISP connection information

The content of ISP connection information is shown in Table 11-14.

Table 11-14 ISP connection information

Information element	Entity who sets	Content	Value
ISP name	Viewer	Name of ISP	UP-TO 64-DIGIT CHARACTER STRING
AP telephone number	Viewer	AP telephone number of ISP	UP-TO 30-DIGIT CHARACTER STRING
User ID	Viewer	User ID of ISP	Up-to 64-digit character string
Pass word	Viewer	Password of ISP	Up-to 32-digit character string
Compression of header	Viewer	Use/non-use of header compression function	- Used·Not used
With/without compression of software	Viewer	With/without compression of software	- Compression is used·No compression
DNS-IP address (primary)	Viewer	IP address of primary DNS server of ISP	Value represented with 32 bits
DNS-IP address (secondary)	Viewer	IP address of secondary DNS server of ISP	Value represented with 32 bits
No-communication cutting-off timer value	Viewer	Time to automatic cutting off when no-communication exists	Operational stipulation

2) Fixed IP connection information

The content of fixed IP connection information is shown in Table 11-15.

Table 11-15 Fixed IP connection information

Information element	Entity who sets	Content	Value
IP address	Viewer	Setting information by viewer with fixed IP address	Value represented with 32 bits
Sub-net mask	Viewer	Information necessary in the case of fixed IP address	Value represented with 32 bits
Default gateway address	Viewer	IP address of router or address of default gateway of ISP	Value represented with 32 bits

3) Connection mode information

The content of connection mode information is shown in Table 11-16.

Table 11-16 Connection mode information

Information element	Entity who sets	Content	Value
IP address gain instruction	Viewer	Protocol etc. to gain IP address in Ethernet connection	-DHCP protocol -Fixed IP address -PPP/PPPoE protocol

4) TCP/IP application setting information

The content of TCP/IP application setting information is shown in Table 11-17.

Table 11-17 TCP/IP application setting information

Information element	Entity who sets	Content	Value
SMTP server name/address	Viewer	SMTP server name/address of ISP	Up-to 128-digit character string or value represented with 32 bits
POP server name/address	Viewer	POP server name/address of ISP	Up-to 128-digit character string or value represented with 32 bits
Mail address	Viewer	Mail address registered in ISP	Up-to 70-digit character string
Mail password	Viewer	Mail password registered in ISP	Up-to 32-digit character string
HTTPProxy server name/address	Viewer	HTTPProxy server name/address of ISP	Up-to 128-digit character string or value represented with 32 bits
HTTPProxy server port number	Viewer	HTTPProxy server port number of ISP	Value represented with 16 bits
FTPProxy server name/address	Viewer	FTPProxy server name/address of ISP	Up-to 128-digit character string or value represented with 32 bits
FTPProxy server port number	Viewer	FTPProxy server port number of ISP	Value represented with 16 bits

11.5.7.2 Communication-related information

The content of communication-related information is shown in Table 11-18.

Table 11-18 Communication-related information

Information element	Entity who sets	Content	Value
Line type	DIRD	Line type that can be connected to DIRD	<ul style="list-style-type: none"> - PSTN - ISDN - PHS [PIAFS2.0/PIAFS2.1] - Portable phone [PDC/CDMACelluarSystem/DS-CDMA/MC-CDMA] - Ethernet
Physical layer protocol	DIRD	Type of protocol for physical layer implemented in DIRD	<ul style="list-style-type: none"> - V.22bis/V.34 or higher - PDC - CDMACellarSystem - PDC-P - PIAFS32k - PIAFS64k - DS-CDMA - MC-CDMA - Ethernet
Data link/transfer protocol	DIRD	Type of data link/transfer protocol implemented in DIRD	<ul style="list-style-type: none"> - PPP - BASIC system - PPPoE - IEEE802.3 - IEEE802.11
Security class	DIRD	Class of security implemented in DIRD	<ul style="list-style-type: none"> - No security - CAS - TLS1.0

11.5.7.3 Security communication-related information

The content of security communication-related information is shown in Table 11-19.

Table 11-19 Security communication-related information

Information element	Entity who sets	Content	Value
Implemented security	DIRD	Type of security implemented in DIRD	<p>Selected from among following algorithm sets according to operational stipulation</p> <ul style="list-style-type: none"> - TLS_NULL_WITH_NULL_NULL - TLS_RSA_WITH_NULL_MD5 - TLS_RSA_WITH_NULL_SHA - TLS_RSA_EXPORT_WITH_RC4_128_MD5 - TLS_RSA_WITH_RC4_128_MD5 - TLS_RSA_WITH_RC4_128_SHA - TLS_RSA_EXPORT_WITH_RC2_CBC_40_MD5 - TLS_RSA_WITH_IDEA_CBC_SHA - TLS_RSA_EXPORT_WITH_DES40_CBC_SHA - TLS_RSA_WITH_DES_CBC_SHA - TLS_RSA_WITH_3DES_EDE_CBC_SHA - TLS_DH_DSS_EXPORT_WITH_DES40_CBC_SHA - TLS_DH_DSS_WITH_DES_CBC_SHA - TLS_DH_DSS_WITH_3DES_EDE_CBC_SHA - TLS_DH_RSA_EXPORT_WITH_DES40_CBC_SHA - TLS_DH_RSA_WITH_DES_CBC_SHA - TLS_DH_RSA_WITH_3DES_EDE_CBC_SHA - TLS_DHE_DSS_EXPORT_WITH_DES40_CBC_SHA - TLS_DHE_DSS_WITH_DES_CBC_SHA - TLS_DHE_DSS_WITH_3DES_EDE_CBC_SHA - TLS_DHE_RSA_EXPORT_WITH_DES40_CBC_SHA - TLS_DHE_RSA_WITH_DES_CBC_SHA - TLS_DHE_RSA_WITH_3DES_EDE_CBC_SHA - TLS_DH_anon_EXPORT_WITH_RC4_40_MD5 - TLS_DH_anon_WITH_RC4_128_MD5 - TLS_DH_anon_EXPORT_WITH_DES40_CBC_SHA - TLS_DH_anon_WITH_DES_CBC_SHA - TLS_DH_anon_WITH_3DES_EDE_CBC_SHA

Information element	Entity who sets	Content	Value
Route CA certificate	DIRD	Certificate of CA that receiving set uses	Operational stipulation

11.5.7.4 Communication device information

The following pieces of information should be set before factory shipping.

(1) Modem

Modem content is shown in Table 11-20.

Table 11-20 Modem

Information element	Set value
Modulation mode	V.34 or higher
Automatic fall down	Set
V.8/V.8bis/V.32 AnnexA Auto mode	Set
Error correction mode	V.42
Data compression mode	V.42bis
Automatic answer	Not set
Dial-tone detection waiting time	3 s
Second dial-tone detection waiting time	3 s
After-dialing carrier waiting time	50 s
Escape code	+<0x2B>
CR code	CR<0x0D>
LF code	LF<0x0A>
BS code	BS<0x08>
Carrier-off detection time	1 s
No-communication cutting-off timer time	Not set
Management when negotiation fails	Cutting the line

(2) TA

TA content is shown in Table 11-21.

Table 11-21 TA

Information element	Set value
Communication speed of TA	64 kbps
Communication mode setting	Conversion between asynchronous and synchronous PPPs
No-communication cutting-off timer time	Not set
Communication system	Beh line exchange
Automatic dial-in	Not set
MP communication	Not used
After-dialing opposite party waiting time	50 s
Escape code	+<0x2B>
CR code	CR<0x0D>
LF code	LF<0x0A>
BS code	BS<0x08>

(3) Ethernet

Ethernet content is shown in Table 11-22.

Table 11-22 Ethernet

Information element	Set value (setting range)
Connection change-over	MDI
Communication method	Automatic detection (full duplex/half duplex)
Frame system	Automatic detection (IEEE802.3/DIX(Ethernet II))
MTU size	Automatic detection (1492 Byte /1500 Byte)

(4) Ethernet (Wireless LAN)

Ethernet (wireless LAN) content is shown in Table 11-23.

Table 11-23 Ethernet (wireless LAN)

Information element	Set value
Communication method	Half duplex
Frame system	IEEE802.11
MTU size	2312 Byte

Chapter 12: Downloading function

The downloading function used to update software/data stored in nonvolatile memory should possess certain characteristics as described below. First, an information transmission scheme is specified, along with preferable specifications for the receiver to be updated by this downloaded information.

12.1 Definitions of terms and service content

12.1.1 Definitions of terms

Notification information: Information used for notification such as the service ID for downloading, scheduling information thereof, and the targetted model of receiver to be updated. It is transmitted using SDTT.

Receiver information: Information on the receiving set, such as maker ID, model number, group number, version number, etc. These pieces of information are stored in nonvolatile memory such as flash memory before shipping.

Compulsory downloading: Downloading that must be executed.

Discretionary downloading: Executable downloading displayed on the screen, and executed in accordance with the viewer's content selections.

12.1.2 Service contents

12.1.2.1 Receiver built-in information update service

Receiver built-in information update service in this document includes the following services that are stored in memory.

- (1) Engineering service (see 12.1.2.2)
- (2) PNG logo service by CDT of TS in each broadcasting station of the digital terrestrial television broadcasting.
- (3) Simple logo service transmitted by the logo transmission description of TS's STD in each broadcasting station of the digital terrestrial television broadcasting.
- (4) Information transmission service related to necessity of updating the receiver software, method and re-packing for mobile receiver transmitted by the SDTT for strong hierarchy of TS for all the broadcasting stations in the digital terrestrial television broadcasting.

Services of EPG, data service, video/audio service to store in memory are not included in the receiver built-in information update service.

12.1.2.2 Engineering service

The engineering service means the following services transmitted by the data carousel. Generally, the engineering service is reported by the SDTT transmitted by the TS of the whole broadcasting station.

- (1) Function updating of the receiver software
Function updating and addition of the receiver software. (Digital terrestrial television, BS/broadband CS digital broadcasting)
- (2) Common data updating
Updating the data used commonly in the receiver.

- Genre code table, program characteristic code table, reservation term table (digital terrestrial television, BS/broadband CS digital broadcasting)
- Logo data (BS/broadband CS digital broadcasting)
- Frequency list, change information (digital terrestrial television broadcasting)

12.2 Transmission scheme relevant to downloading

In this section, stipulations of transmission scheme are provided for both notification information concerning download scheduling, etc., and download contents.

12.2.1 Transmission scheme of notification information

12.2.1.1 Software Download Trigger Table

To provide notice of download information, a Software Download Trigger Table is used. However, the software download trigger table is not used for the download content transmitted by the section format in 12.2.2.2.

Table 12-1 Data structure of Software Download Trigger Table

Data structure	Number of bits	Representation of bit string
Software_download_trigger_section0{		
Table_id	8	uimsbf
Section_syntax_indicator	1	bslbf
Reserved_future_use	1	bslbf
Reserved	2	bslbf
Section_length	12	uimsbf
Table_id_ext	16	uimsbf
Reserved	2	bslbf
Version_number	5	uimsbf
Current_next_indicator	1	uimsbf
Section_number	8	uimsbf
Last_section_number	8	uimsbf
Transport_stream_id	16	uimsbf
Original_network_id	16	uimsbf
Service_id	16	uimsbf
Num_of_contents	8	uimsbf
For(i=0;i<num_of_contents:I++){		
Group	4	bslbf
target_version	12	uimsbf
new_version	12	uimsbf
download_level	2	bslbf
version_indicator	2	bslbf
content_description_length	12	uimsbf
Reserved	4	bslbf
schedule_description_length	12	uimsbf
schedule_time-shift_information	4	uimsbf
for(i=0;i<N;i++){		
start_time	40	uimsbf
duration	24	uimsbf
}		
for(j=0;j<N2;j++){		
descriptors()		
}		
}		
CRC_32	32	rpchof
}		

Definitions for the Software Download Trigger Table:

table_id: 0xC3

section_syntax_indicator: 1

section_length: This field contains the number of bytes from immediately after the section-length field to a section end, including CRC. Section length must not exceed 4093.

table_id_extension:

Data structure	Number of bits	Representation of bit string
maker_id	8	uimsbf
model_id	8	uimsbf

version_number:

This field indicates a version number of a sub table. The version number is incremented, accompanied with a change of information in the Sub-Table. When the value reaches 31, it returns to 0.

current_next_indicator:

1

section_number:

This field indicates the section number.

last_section_number:

This field indicates the last section number of the sub table to which the section belongs.

transport_stream_id:

A label with which the transport stream is identified from other multiplexed transport streams in the network.

original_network_id:

A label that designates the network identification of the original delivery network.

service_id:

A label to discriminate the service by which the download content is transmitted.

num_of_contents:

This field indicates the number of download content notified in this table.

group:

This field contains group_id.

target_version:

This field indicates version number of the download content to be updated.

new_version:

This field indicates a version number of content to be downloaded.

download_level:

“01” indicates compulsory downloading, and “00” indicates discretionary downloading.

version_indicator:

- 00: All versions are targeted (Version specification is invalid).
- 01: Version(s) specified or later are targeted.
- 02: Version(s) specified or earlier are targeted.
- 03: Only specified version is targeted.

content_description_length():

This field indicates total byte length of a schedule loop and a descriptor loop.

schedule_description_length:

This field indicates byte length of the schedule loop. When this value is 0 in all receiver common data, it indicates that the intended download content is being transmitted.

schedule_time-shift_information: Explanation of the schedule time-shift information follows.

- 0: The same download content is transmitted by the same schedule with multiple service_id
- 1 to 12: The same download content is transmitted by shifting the time of 1 to 12 hours for each service_id with multiple service_id
- 13 to 14: Reserved
- 15: The download content is transmitted with a single service_id.

For detailed operation such as specification method of service_id when transmitting the download content in multiple service_id, see “Download Function” in Appendix 3 of this document and Operational Manual for Broadcasting Service Provider.

start_time: This field indicates time of distribution of download content, using Japan Standard Time (JST) and Modified Julian Date (MJD).

duration: This field indicates duration time of distribution in second.

descriptor(): Download Content Descriptor shown in Table 12-2 is placed.

Table 12-2 Structure of Download Content Descriptor

Data structure	Number of bits	Representation of bit string
<pre>Download_content_descriptor () { descriptor_tag descriptor_length reboot add_on compatibility_flag module_info_flag text_info_flag reserved component_size download_id time_out_value_DII leak_rate reserved component_tag if (compatibility_flag == '1') { compatibilityDescriptor() } if (module_info_flag == '1') { num_of_modules for (i=0; i<num_of_modules; i++) { module_id module_size module_info_length for (i=0; i< module_info_length; i++) { module_info_byte; } } } private_data_length for (i=0; i<private_data_length ; i++) { private_data_byte } if (text_info_flag == '1') { ISO_639_language_code text_length for(i=0;i<N;i++){ text_char } } }</pre>	<p>8</p> <p>8</p> <p>1</p> <p>1</p> <p>1</p> <p>1</p> <p>1</p> <p>3</p> <p>32</p> <p>32</p> <p>32</p> <p>22</p> <p>2</p> <p>8</p> <p>16</p> <p>16</p> <p>32</p> <p>8</p> <p>8</p> <p>8</p> <p>24</p> <p>8</p> <p>8</p>	<p>uimSBF</p> <p>uimSBF</p> <p>bslbf</p> <p>bslbf</p> <p>bslbf</p> <p>bslbf</p> <p>bslbf</p> <p>bslbf</p> <p>uimSBF</p> <p>uimSBF</p> <p>uimSBF</p> <p>uimSBF</p> <p>bslbf</p> <p>uimSBF</p> <p>uimSBF</p> <p>uimSBF</p> <p>uimSBF</p> <p>uimSBF</p> <p>uimSBF</p> <p>uimSBF</p> <p>uimSBF</p> <p>uimSBF</p> <p>uimSBF</p>

descriptor_tag:

A label with which the Download Content Descriptor is identified. The value is 0xC9.

reboot:

Flag indicating whether it is necessary to restart the receiver upon completion of downloading. “1” indicates restart, and “0” indicates continuous operation.

add_on:	Flag indicating whether an overwrite of an existing module or addition occurs. “1” indicates addition, and “0” indicates overwrite.
compatibility_flag:	Flag indicating the presence/absence of a compatibilityDescriptor() in the descriptor. “1” indicates that compatibilityDescriptor() is present, and “0” indicates that it is not.
module_info_flag:	Flag indicating the presence/absence of information for each module in the descriptor. “1” indicates that information for each module is present, and “0” indicates that it is not.
text_info_flag:	Flag indicating the presence/absence of service description at the end of the descriptor. “1” indicates that the service description is present, and “0” indicates that it is not.
component_size:	This field contains the sum of data sizes that are transmitted in the carousel in byte.
download_id:	This field specifies download identification for the purpose of identifying an application number for this download. The download identification specified here is also specified in DII/DDB when actual distribution is done.
time_out_value_DII:	This field indicates recommended time-out value in millisecond for all DII section reception of the corresponding carousel.
leak_rate:	Leak rate of the transport buffer of the receiver. Unit is bytes/s.
reserved:	This 3-bit field is reserved for future use.
component_tag:	This 8-bit field contains a component tag of a corresponding stream that is given by a stream identification descriptor in PMT.
compatibilityDescriptor():	This field contains compatibilityDescriptor which is the same as that in DII. Any target to be updated by this download which cannot be specified by table_id_ext/group in SDTT must be specified by using information here.
number_of_modules:	This field indicates the number of modules.
module_id:	Identification of a module in the carousel to download contents.
module_size:	This field indicates byte length of the module concerned. “0” indicates undefined length.
module_info_length:	Byte length of module_info_byte.
module_info_byte:	This field contains necessary descriptors, i.e., Type Descriptor, Name Descriptor, Info Descriptor, or Control Descriptor as described in DII.
private_data_length:	Byte length of private_data_byte.
private_data_byte:	Use of this area is beyond the scope of this specification.

ISO_639_language_code:	This field specifies language of character description used for the service description.
text_length:	Length of the service description in byte.
text_char:	Description concerning the service of the download content to be transmitted.

12.2.1.2 Transmission of SDTT

Digital terrestrial television broadcasting can make a hierarchy transmission which transmits a signal having multiple transmission parameters simultaneously. The signal can be transmitted to a mobile receiver unit using strong hierarchy with transmission scheme having strong error resistance, and the signal can be transmitted to a fixed receiver unit on weak hierarchy using a transmission scheme that can transmit a large capacity. In this case, different content of SDTT (Software Download Trigger Table) can be transmitted for each receiver unit that receives the signal. Therefore, a different PID is applied to each SDTT to discriminate the SDTT transmitted in strong hierarchy and weak hierarchy (see ARIB STD-B10). However, the data structure and Table_id of the SDTT should be the same.

12.2.2 Transmission scheme of the content

The download content can be transmitted by a data carousel and section table.

12.2.2.1 Download content data carousel transmission scheme

Additional specifications concerning download to the DSM-CC data carousel transmission regulations are described below.

The download content is transmitted through the use of DDB of the DSM-CC data carousel. A data format that relates to common data to all receivers is specified in Appendix A of “Appendix (Downloading Function).” No specification concerning other data formats is provided here.

(1) Addition of compatibility Descriptor in DII

It is necessary to use compatibility Descriptor in DII to specify the target receiver of download. It is assumed that the semantics and syntax of compatibilityDescriptor are used. The syntax is shown in Table 12-3.

Table 12-3 CompatibilityDescriptor format

Syntax	Number of bytes
CompatibilityDescriptor(){	
CompatibilityDescriptorLength	2
DescriptorCount	2
for (i=0 ; i<descriptorCount ; i++){	
descriptorType	1
descriptorLength	1
specifierType	1
specifierData()	3
model	2
version	2
subDescriptorCount	1
for (j=0 ; j< subDescriptorCount ; j++){	
subDescriptor()	
}	
}	
}	

Syntax	Number of bytes
<pre> SubDescriptor() { SubDescriptorType SubDescriptorLength for (k=0 ; k< subDescriptorLength ; k++){ additionalInformation } } </pre>	<p>1</p> <p>1</p> <p>1</p>

Additional specifications to original DSM-CC data carousel is described to specify the target receiver flexibly and in detail.

Maker identification (maker_id), model identification (model_id) and version identification (version_id) must be contained in compatibilityDescriptor in the header of DII (Download Info Indication).

By including a plurality of descriptors in this compatibilityDescriptor describing models that should download the software, it becomes possible for models from multiple makers to download the software at the same time. Note that if there are two or more Descriptors of the same DescriptorType, the models that should download the software must be specified by an OR (logical sum) operation of the Descriptors; however, if there are two or more Descriptors of each different DescriptorType, the models that should download the software must be specified by an AND (logical product) operation.

A method of specifying models of the target receivers of download must be specified by DescriptorType, and specification by hardware and/or by software must be possible.

Identification fields of the model information are shown in Table 12-4.

Table 12-4 Identification field

Field	Content	Number of bits
specifierType	0xFF	8
specifierData()	Code indicating "ARIB"(0x819282)	24
model	Equivalent to (maker_id)	8
	Equivalent to (model_id)	8
version	Assigned to (group_id)	4
	Equivalent to (version_id)	12

The version field is divided between a version_id of 12 bits and a group_id of 4 bits (group identification). Here, group_id is provided to divide the receivers that should download the software into several groups with the intention to mitigate power plant load.

It is also possible to consider Virtual Machine as a specific model, and hence, all receivers having Virtual Machine are made to download the same software.

(2) Addition of descriptor for DII Module Info

Information of the download content must be described in Module Information area in a DII message of DSM-CC data carousel. The information is transmitted using several descriptors that have already been defined in other ARIB specifications. DII (DownloadInfoIndication Message) format is shown in Table 12-5.

Table 12-5 DII (DownloadInfoIndication Message) format

Syntax	Number of bytes
DownloadInfoIndication(){	
DsmccMessageHeader()	
DownloadId	4
BlockSize	2
WindowSize	1
AckPeriod	1
TCDownloadWindow	4
TCDownloadScenario	4
CompatibilityDescriptor()	
NumberOfModules	2
for (i=0 ; i< numberOfModules ; i++){	
moduleId	2
moduleSize	4
moduleVersion	1
moduleInfoLength	1
for (j=0 ; j< moduleInfoLength ; j++){	
ModuleInfoByte	1
}	
}	
PrivateDataLength	2
for (i=0 ; i< PrivateDataLength ; i++){	
PrivateDataByte	1
}	
}	

Descriptors contained in ModuleInfoByte for the use of download will be described in the following.

Type Descriptor contains module type description that indicates the module carries download content. A receiver discriminates that whether the module carries content of the data services or content of the download by this descriptor. Notation of module type follows the “Media Type” notations in RFC2046.

Example: application/x-download indicates that it is the download content.

Though actual description of module type may vary by targeted receiver model, the notation must always follow that in RFC2046.

A module name is described in the Name Descriptor. The name should be unique in all the module names in a receiver system. For example, if all software components of a receiver system consist of module based manner on a file system, the path of the targeted module on the file system is described in this Name Descriptor.

Further additional information of the module to be downloaded is described in info Descriptor. The information content in Info Descriptor must be in Plain Text. When an optional byte data is added to the module, the Control descriptor should be operated.

download_data_id: This is a 16-bit field which identifies the download data identifier of the whole receiver common data. The download data identifier should be unique for each original network identifier (`original_network_id`). In the case of the service logo, this value coincides with the value of `download_data_id` denoted in the logo transmission descriptor, mentioned later, located in the STD.

version_number: This 5 bit field is a version number of sub-table. When there is any change in the information of sub-table, 1 is added to the version number. When the value becomes 31, it returns to 0. When the current next indication is “1”, version number is the actual sub-table version number defined by the table identifier and network identifier. When the current next indication is “0”, version number is the next sub-table version number defined by the table identifier and network identifier.

current_next_indicator: When the indication is “1”, it means that the sub-table is the actual sub-table. When the indication is “0”, the sub-table to be sent is not yet applied and is used as the next sub-table.

section_number: This 8 bit field indicates the section number. The section number of the first section in the sub-table is 0 x 00. Section number adds 1 whenever the section having the same table identifier and network identifier are added.

last_section_number: This 8 bit field specifies the number of the last section (section which has the maximum section number) of the sub-table in which the section belongs.

original_network_id: This is a 16-bit field and works as a label to specify the network identifier of the original distribution system.

data_type: This 8 bit field indicates the type of transmitted download data. 0x01 is the logo data. For operational detail, see “Download function” of Appendix 3 of this document and broadcasting service provider function. Others are for future extensions.

descriptors_length: This 12 bit field indicates all byte numbers of network descriptor that follows it.

data_module_byte: This field denotes the download data by the syntax defined for each `data_type`. In the case of service logo, see “Download function” in Appendix 3 of this document and broadcasting service provider function.

CRC_32: This is a 32-bit field, which includes CRC value with register output zero after processing overall section in the decoder defined in ARIB STD-B10 Appendix B.

(2) Download data specifying scheme

The downloaded data is specified by the download data identifier. The download data identifier specifies using identifier, etc., according to the content and purpose of the download data. For digital terrestrial television broadcasting, the service logo data is specified using the Logo transmission descriptor located in the SDT (Service Description Table).

For logo transmission descriptor, see also ARIB STD-B10. Data structure of logo transmission descriptor is as shown in Table 12-7.

Table 12-7 Logo transmission descriptor syntax

Data Structure	Bit Number	Bit String Notation
logo_transmission_descriptor(){		
descriptor_tag	8	uimsbf
descriptor_length	8	uimsbf
logo_transmission_type	8	uimsbf
if(logo_transmission_type == 0x01){		
reserved_future_use	7	bslbf
logo_id	9	uimsbf
reserved_future_use	4	bslbf
logo_version	12	uimsbf
download_data_id	16	uimsbf
}		
else if(logo_transmission_type == 0x02){		
reserved_future_use	7	bslbf
logo_id	9	uimsbf
}		
else if(logo_transmission_type == 0x03){		
for(i=0;i<N;i++){		
logo_char	8	uimsbf
}		
}		
else{		
for(j=0;j<M;j++){		
reserved_future_use	8	bslbf
}		
}		
}		

logo_transmit_type (Logo transmission type): This 8-bit field indicates the logo transmission type shown in Table 12-8.

Table 12-8 Logo transmission type

logo_transmit_type value	Explanation
0x1	CDT Transmission scheme 1 : When referring CDT directly with download data identifier.
0x2	CDT Transmission scheme 2 : When referring download data identifier indirectly using logo identifier of the CDT.
0x3	Simple logo scheme
Other than above	Reserved for future use

logo_id (Logo identifier): This 9 bit denotes the ID value of the logo data defined in this service.

download_data_id (Download data identifier): This 16 bit indicates the identifier of the downloaded data. It coincides with the table_id_extension value of CDT by which the logo data is located.

logo_version (Logo version number): This 12 bit denotes the version number of this logo_id. This field is given the same value as the logo version number of data_module_byte() in the CDT. (See “Download function” of Appendix 3 of this document and broadcasting service provider function.)

logo_char (Character line for simple logo): This 8 bit denotes character line of 8-unit code for simple logo.

12.3 Preferable specifications of the receiver

The necessary functions and capacity and performance of the receiver to achieve information revision service for the receiver are described below.

12.3.1 Necessary functions

The receiver should have following functions for information revision service for the receiver.

(1) To schedule the execution of download, the receiver should have abilities:

- to receive notification information with satisfying other receiver operations
- to decode and evaluate notification information
- to determine to schedule the execution or not in accordance with the result of evaluation, such as download of common data for all receivers or download of receiver content that meets receiver information etc.
- not to attract users' attention when notified download is compulsory download and users' permission was given beforehand
- to display selection list and to offer a control method to users to select content to be downloaded, then to follow the users' selection for scheduling when notified download is discretionary download

(2) When receiving download content, the receiver should:

(a) In case of data carousel format download content

- have the ability to receive the download content that is transmitted in DSM-CC data carousel according to the notification information and store the downloaded content in non-volatile memory¹⁾
- have the ability to evaluate the validity and compatibility of the received download content and store the downloaded content in non-volatile memory
- follow the notification information; i.e. When schedule information²⁾ is available, the receiver executes the downloading according to the schedule information while the receiver is on standby. When there is no schedule information, the receiver tries to perform the downloading when a switch-OFF operation is initiated.
- avoid any disturbances to current program viewing. For example, the receiver is permitted to execute the reception of downloading content when a service for download is found in a TS that is currently selected for users' program viewing, reboot of modified software in receiver memory is suspended until the receiver is turned off (on standby), etc.

(b) In case of section format download content

1 In compulsory downloading, the user must not be inconvenienced; proper caution in this regard is required. An example is shown in "Handling of the Compulsory Downloading," found in the "Appendix (Downloading Function)" section.

2 "When schedule information is available" refers to cases where the number of loops of the schedule information in SDTT is not 0; "when there is no schedule information" refers to a case where it is 0.

- (3) To recover the functions of a receiver in case of emergency, the receiver should:
 - have ability to detect emergency, such as turning off the receiver while receiving, error or exception while processing the downloaded content, or imperfection of received data etc.
 - have ability to start system recovery method
 - have ability to invalidate downloaded content and to secure system configuration necessary to reacquire the download content once emergency was detected while downloading
 - execute the program existed before downloading to start the receiver if it has two-bank memory system in which two memory areas to be used for overwriting through the downloading are equipped to enhance safety, or execute the inherit program to start the receiver if it has one-bank plus α memory system in which an inherit program area that cannot be overwritten and a memory area to be overwritten through downloading are equipped in order to secure minimum receiver functions.
- (4) To permit a receiver to execute download, the receiver should have abilities to:
 - offer a control method to users to choose whether it is granted or not
 - retain given permission information
- (5) A receiver should have abilities to control its power supply unit to:
 - turn on necessary circuits to receive download content by its own timer programmed by itself according to the notification information
 - turn off the circuits when download operation completed
 - keep necessary circuits functional to perform download when a receiver is turned off. After the completion of downloading, the circuits should also be turned off in this case.

12.3.2 Necessary capacity and performance of receiver hardware

A receiver, that satisfies the specification described in 12.3.1 should have the following capacity and performance.

- (1) A receiver should have enough buffer memory against transmission speed for both notification information and download contents.
- (2) For a memory area for common data to all receivers explained in detail in Appendix A of “Appendix (Download Function)”, the receiver should devote at least 10K byte for the BS receiver, 30K byte for the BS and broadband CS receiver, 10K byte for the terrestrial receiver, and 40K byte for the terrestrial/BS/broadband CS-compatible receiver. Various common use receivers shall be able to share the memory for the genre code table, the reserved word table and the like that are commonly used in all transmission media.

Furthermore, the data area storing the logo data used in EPG etc. should be secured.

- (3) To recover a receiver functions and maintain the ability to receive broadcasting services, the receiver must have one of the two following memory structures: a two-bank memory system (in which two banks of nonvolatile memory are used to enable backtracking to a state prior to the downloading); or a one-bank plus α memory system (in which one bank of memory area is assigned to be overwritten by the downloading and the inherent program is kept permanently in the memory).

Chapter 13: Signal processing functions of DIRD

13.1 Service information

DIRD must have a function of receiving and presenting several pieces of information that are stipulated as required to the service information as defined separately by an ARIB standard, including PSI provided by the Ministerial Ordinance.

13.2 Identification between broadcasting and non-broadcasting

DIRD must have a function of selecting signals that are defined as of broadcasting according to the flow shown in Fig. 13-1 with the use of the system management descriptor that is separately stipulated.

13.3 Number of PIDs to be simultaneously processed

Twelve or more including components of the main line system.

13.4 Number of scramble keys that can be set for scrambling

Eight pairs or more, where one pair is composed of one odd key and one even key.

13.5 Flow of program selection

Program selection must be performed according to the flow of Fig. 13-2.

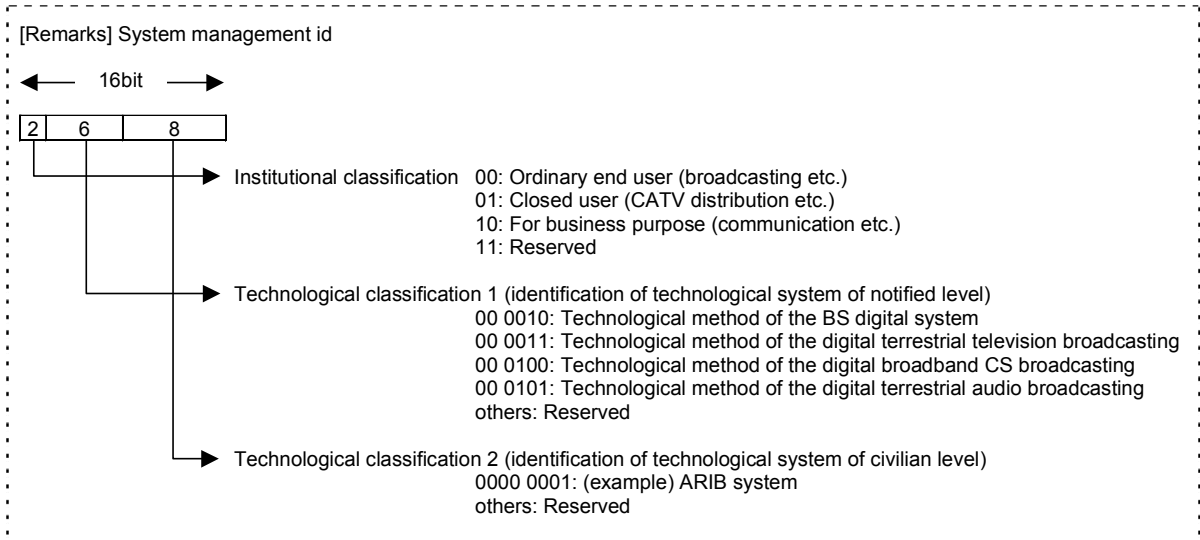
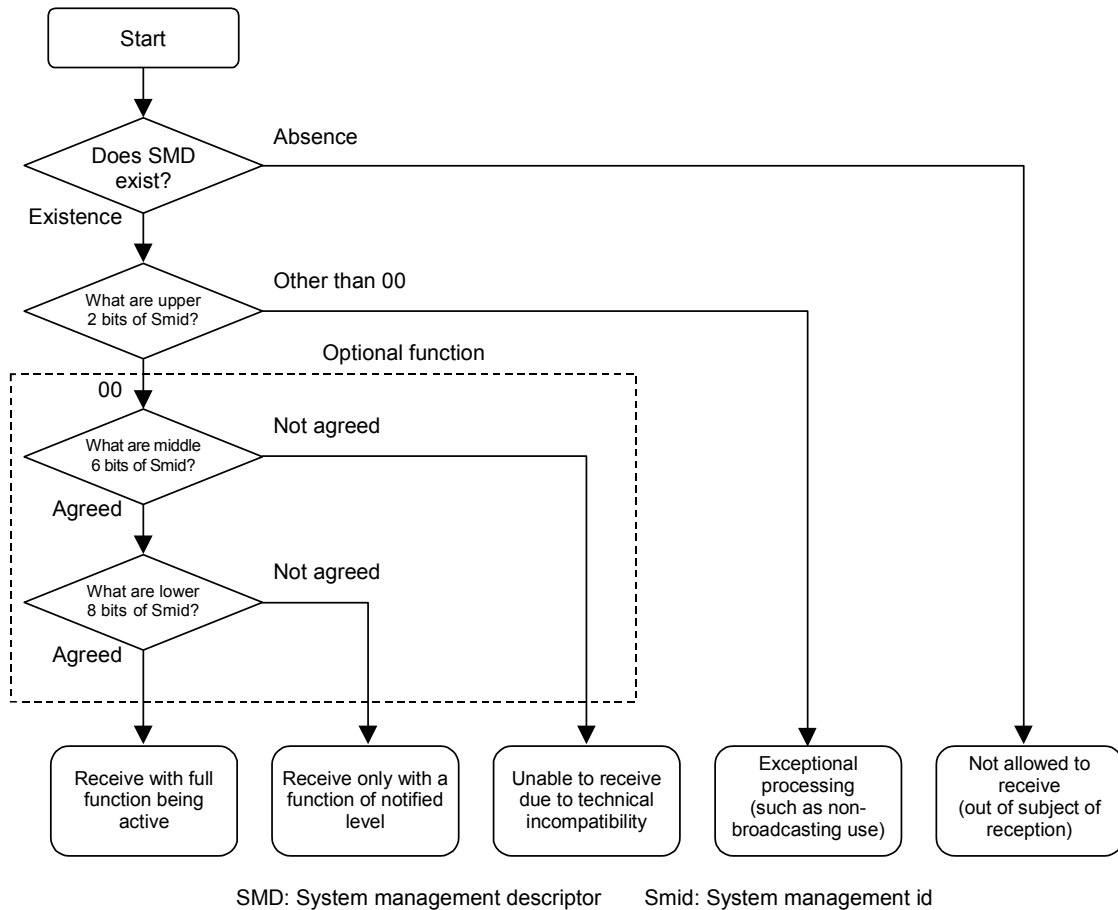
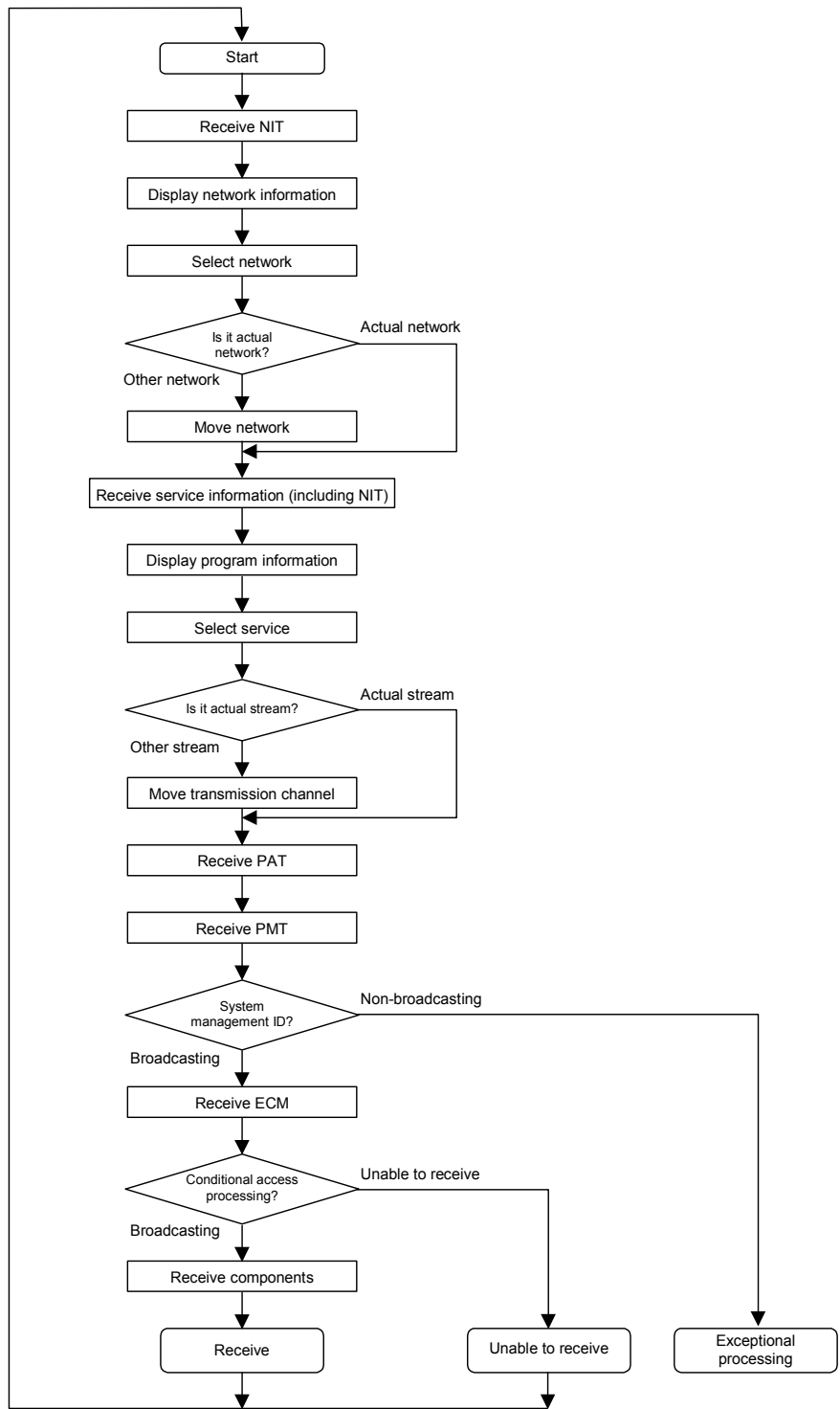

Fig. 13-1 Identification flow of broadcasting/non-broadcasting



[Notes]

- (1) Only basic flow is showed. It is also acceptable to provide branching/short-circuit routes, etc. as an additional receiver function.
- (2) After reception of a broadcast containing proper NIT and service information, the flow would not proceed into the exceptional processing.
- (3) In exceptional processing, processing such as re-setting to capture the broadcast wave correctly, or special processing when the receiver is used for non-broadcasting reception (uploading of the system management ID, etc.) is conducted.

Fig. 13-2 Basic flow of program selection

Chapter 14: Performance of receiver units

The performance of units of the digital satellite broadcast receiver must be as described in Tables 14-1 to 14-3.

Performance of units of the digital terrestrial television broadcast receiver is described in Chapter 5. See also Appendix-10, “About performance of the receiver for the digital terrestrial television broadcasting.”

14.1 Satellite receiving antenna

Table 14-1 Desirable performance of satellite receiving antenna

Item		Performance
G/T		Must be 13 dB/K or more
Directivity	Effective diameter of less than 90 cm	Must be not less than value of curve A in Fig. 14-2
	Effective diameter of 90 cm or more	Must be not less than value of curve A' in Fig. 14-2
Cross-polar characteristic		Must be not less than value of curve B in Fig. 14-2
VSWR		1.3 or less in receiving band, for antenna alone 2.5 or less at converter output, for all-in-one type with converter

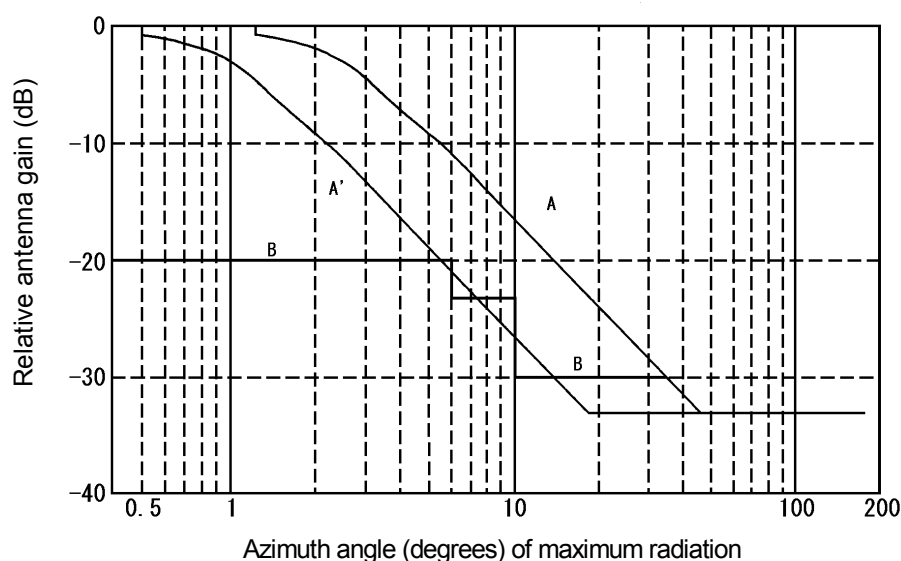

Fig. 14-1 Curves of directivity and cross-polar characteristic

In the future, interference from foreign satellites will likely affect domestic satellite broadcasting due to constraints on satellite orbits and resources. As part of international coordination to avoid such interference between domestic and foreign satellites, it is expected that antenna characteristics will have to meet Recommendation ITU-R BO.1213, a prerequisite of the present broadcasting satellite plan. Recommendation ITU-R BO.1213 is shown in Appendix-7.

14.2 Satellite converter

Table 14-2 Desirable performance of satellite converter

Item	Performance
Noise factor	1.2 dB or less
Input VSWR	2.5 or less in receiving band
Gain deviation in receiving band	4 dB(p-p) or less in receiving band of BS and in that of broadband CS 6 dB(p-p) or less in receiving bands of BS and broadband CS
Gain deviation in received channel	Within 1 dB(p-p) in received channel band
Output VSWR	2.5 or less in receiving band
Frequency drifting of local oscillator	Within ± 1.5 MHz (-30 to $+50^{\circ}\text{C}$)
Leakage of local oscillator output	-30 dBm or less at reception input terminal
Local oscillator phase noise	-52 dBc/Hz (1 KHz) or less -70 dBc/Hz (5 KHz) or less -80 dBc/Hz (10 KHz) or less
Intermodulation level	-55 dB or less for two input signals each of -70 dBm
Image interference suppression ratio	31 dB or more

14.3 Satellite DIRD

Table 14-3 Desirable performance of satellite DIRD

Item	Performance
Leaky electric power of local oscillator	-55 dBm or less at input terminal
Input VSWR	2.5 or less in receiving band
Required CN ratio	Reception impairment must not be detected under the condition of a CN ratio of 11 dB (noise bandwidth: 28.9 MHz, only white noise). Note that broadcasting signals, both desired wave and interfering wave, to be used in measurement must be signals that were transmitted through a transmission path equivalent to satellite repeater.
Interference suppression capability	Must meet the following conditions at 8PSK, with a CN ratio of 17 dB (Required CN +6 dB: noise bandwidth 28.9 MHz). Note that broadcasting signals, both a desired wave and an interfering wave, to be used for measurement must be signals that were transmitted through a transmission path equivalent to the satellite repeater. Co-channel* Adjacent channel (N \pm 1)* Adjacent channel (N \pm 2)* Intermodulation Spurious Second local oscillator image
AFC characteristic	For variation of input signal frequency of ± 1.5 MHz, no reception impairment is detected.

* The interfering wave must be a digital modulated wave having the same symbol rate and filter characteristic as those of the desired wave.

Note that if during measurement, the satellite repeater or the transmission path equivalent thereto cannot be prepared, the standard shown in Appendix-8 must be met instead.

Chapter 15: Receiver compatible with other media (option)

15.1 Making the digital broadcast receiver compatible with other media and the interoperability connection unit

This chapter outlines stipulations for digital broadcast receivers intended to be compatible with other media. Section 15.1.1 describes how to ensure compatibility between the digital satellite broadcast receiver and digital terrestrial television broadcast receiver, and introduces an interoperability connection unit equivalent to the TS interface. The concept of making the receiver compatible with narrow-band CS digital broadcasting and/or digital CATV is under considering, as is an interoperability connection unit that corresponds to the TS interface.

15.1.1 Enabling the digital satellite broadcast receiver to receive digital terrestrial television broadcasts receiving adapter and interoperability connection unit

15.1.1.1 Making the digital satellite broadcast receiver compatible with digital terrestrial television broadcasting

A “digital terrestrial television broadcasting compatible” dual-purpose BS digital broadcast/digital terrestrial television broadcasting compatible BS and broadband CS digital broadcast receiver (hereafter referred to as a “terrestrial-compatible BS/BS broadband CS receiver”) must be: a) previously equipped with a connection unit to a digital terrestrial television broadcast adapter (hereinafter referred to as a “terrestrial adapter”) and b) capable of receiving digital terrestrial television broadcasting. The range of standardization under this standard must be as follows.

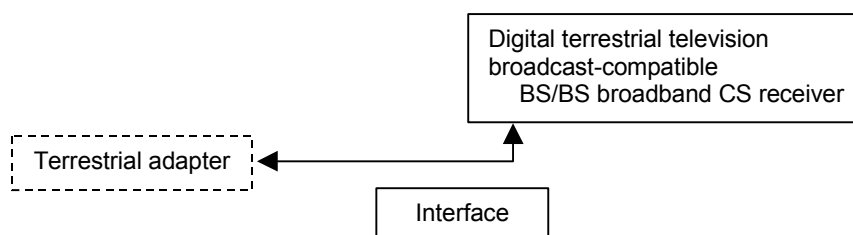

Fig. 15-1 Ensuring compatibility with digital terrestrial television broadcasts (block diagram)

This standard is intended to cover standardization issues for the above-mentioned terrestrial-compatible BS/BS broadband CS receiver and its interface. Note that the terrestrial adapter must conform to the standard for digital terrestrial television broadcast receivers. For more information on descriptor, command, and tuner model of the terrestrial adapter, refer to “Descriptor, command, and tuner model of terrestrial adapter” in Appendix 5.

15.1.1.2 Interface necessary for a digital terrestrial television broadcast-compatible receiver

(1) Specifications of the serial interface and input stream

The serial interface must adhere to IEEE1394 specifications, and more specifically, to IEEE Std 1394-1995, the “IEEE Standard for a High Performance Serial Bus.”

The terrestrial-compatible BS/BS broadband CS receiver must receive a full TS that is tuned in by the terrestrial adapter.

For the terrestrial-compatible BS/BS broadband CS receiver to enable the terrestrial adapter to tune in and perform a reception search, three parameters must be correct: the DSIT command, whereby the received frequency is transmitted; the Tuner Status Descriptor, whereby the

state of the terrestrial adapter is known; and the Tuner Subunit Identifier Descriptor, whereby the terrestrial adapter is recognized. These parameters are stipulated below.

(2) Commands

The terrestrial-compatible BS/BS broadband CS receiver must conform to several specifications in 1394 Trade Association, including the AV/C Descriptor Mechanism Specification (hereinafter, AV/C Descriptor), AV/C Tuner Model and Command Set (hereinafter, AV/C Tuner); the AV/C Tuner Broadcast System Specification — Digital Video Broadcast (DVB); and the Enhancements to the AV/C Broadcast System Specification — Digital Video Broadcast (DVB). Also, to control tuning the terrestrial adapter equipped with functions stipulated by Profile E0: Conformant_implementation of AV/C Tuner, must support the following commands. For details of the AV/C Descriptor commands, see AV/C Descriptor; for details of the AV/C Tuner commands, see AV/C Tuner.

The terrestrial-compatible receiver must support at least the AV/C General commands shown in Table 15-1.

Table 15-1 Essential AV/C Descriptor commands

Opcode	Value	Command Type	Description	Support
OPEN DESCRIPTOR	0x08	CONTROL	Acquires access right of Descriptor.	Required (Note 1)
OPEN DESCRIPTOR	0x08	STATUS	Checks access state of Descriptor.	Required
READ DESCRIPTOR	0x09	CONTROL	Reads data from Descriptor.	Required

Note 1: The OPEN DESCRIPTOR command supports only read_open subfunction(0x01) and close subfunction(0x00).

To enable the terrestrial adapter to perform tuning, the terrestrial-compatible receiver must support the AV/C Tuner commands in Table 15-2.

Table 15-2 Essential AV/C Tuner commands

Opcode	Value	Command Type	Description	Support
DIRECT SELECT INFORMATION TYPE (DSIT)	0xC8	CONTROL	Frequency tuning (replace subfunction is required)	Required (Note 1)

Note 1: The DIRECT SELECTION INFORMATION TYPE command must support the replace subfunction(0xD2).

(3) DIRECT SELECT INFORMATION TYPE (DSIT) command

The structure of the `system_specific_mux_selection` field of the DSIT command is shown in Table 15-3. The tuning of the terrestrial adapter is conducted using `center_frequency`.

Table 15-3 `System_specific_mux_selection` field

Structure	Number of bits
system_specific_mux_selection {	
system_specific_mux_attributes_valid_flags {	
reserved_field, center_frequency, bandwidth, constellation, hierarchy_info, code_rate-HP_stream, code_rate-LP_stream, guard_interval	8
network_id, transmission_mode, other_frequency_flag, reserved (5bit)	8
}	
system_specific_mux_selection_attributes {	
currently_available, selected, reserved (6bit)	8
center_frequency	32
bandwidth(3bits), reserved(5bits)	8
constellation(2bits), hierarchy_info(3bits), code_rate-HP_stream(3bits)	8
code_rate-LP_stream(3bits), guard_interval(2bits), transmission_mode(2bits), other_frequency_flag	8
network_id	16
}	
}	

- `system_specific_mux_attributes_valid_flags`
Since `center_frequency` is used in making the terrestrial adapter perform the tuning, the `center_frequency` field must be set to “1.”
- `center_frequency`
This specifies the center frequency of a broadcast to which the terrestrial-compatible receiver is tuned. The `center_frequency` is a 32-bit field, and values are expressed therein in increments of 10 Hz. (Refer to “Received frequency” in Appendix 5.)

The response of the terrestrial adapter to the DSIT command from the terrestrial-compatible BS/BS broadband CS receiver is shown in Table 15-4.

Table 15-4 DSIT command response

State of terrestrial adapter at the time of receiving DSIT command	Response code	Status (HEX) in response frame
Tuning according to command	ACCEPTED	0x00
Sending back ACCEPTED when tuning is not completed (Note 1)	ACCEPTED	0x01
Unable to tune in	REJECTED	0xFF
Command is not supported	NOT IMPLEMENTED	0xFF

Note 1: The terrestrial-compatible BS/BS broadband CS receiver can confirm the state of tuning of the terrestrial adapter using Tuner Status Descriptor according to the following procedure:

1. The receiver confirms that searching field of antenna_input_info becomes “0.” The confirmation of Tuner Status Descriptor is repeated until the searching field becomes “0.”
2. The receiver confirms a currently_available field of system_specific_multiplex_selection_attributes.
3. The receiver confirms the center frequency of the tuned broadcast by the center_frequency field of system_specific_multiplex_selection_attributes.
4. When receiving state information is necessary, the receiver confirms the value of signal_strength field of antenna_general_system_info.

(4) Descriptor

To identify the terrestrial adapter and learn its status, the terrestrial-compatible BS/BS broadband CS receiver must be able to access the two descriptors in Table 15-5. For details of the Tuner Subunit Identifier Descriptor and Tuner Status Descriptor, see AV/C Tuner.

Table 15-5 Descriptors

Descriptor	descriptor_type	Description	Support
Tuner Subunit Identifier Descriptor	0x00	Indicates capability/feature of Tuner Subunit.	Required
Tuner Status Descriptor	0x80	Indicates a state of Tuner Subunit.	Required

The terrestrial adapter must support the Tuner Subunit Identifier Descriptor, and must also support at least subsystem_label of the system_specification loop therein.

- subsystem_label
This field enumerates the broadcasting systems that can be received. Each label accommodates 9 characters. Each character is coded according to ASCII alphanumerics. This field takes a value shown in Table 15-6 for the terrestrial adapter. The terrestrial-compatible BS/BS broadband CS receiver identifies the terrestrial adapter by the subsystem_label field.

Table 15-6 Subsystem_label

Value	Meaning
JPNTBADPT	terrestrial adapter

In addition, the terrestrial adapter must support Tuner Status Descriptor, and must also support at least a searching field of antenna_input_info therein, signal_strength field of antenna_general_system_info therein, the currently_available field, and the center_frequency field of system_specific_multiplex_selection_attributes therein.

- searching
The function of a searching field is shown in Table 15-7.

Table 15-7 Searching field

Field	Meaning
searching	In operation of tuning = 1

When searching = 1 (during tuning operations), the terrestrial-compatible BS/BS broadband CS receiver must regard the fields currently_available and signal_strength as invalid.

- signal_strength
The function of signal_strength is shown in Table 15-8. The signal_strength indicates information on the receiving status of the terrestrial adapter. The higher the value is, the better receiving status it indicates. The maximum value is 255. When currently_available = 0, the terrestrial-compatible BS/BS broadband CS receiver regards signal_strength field as invalid.

Table 15-8 signal_strength field

Field	Meaning
signal_strength	Indicates receiving state of the terrestrial adapter.(0-255)

- currently_available field
The function of currently_available is shown in Table 15-9.

Table 15-9 currently_available field

Field	Meaning
currently_available	Normal operation of tuning is completed (under normal reception) = 1

- center_frequency
Center_frequency indicates the center frequency of a broadcast currently being received by the terrestrial adapter.

Table 15-10 Center_frequency field

Field	Meaning
center_frequency	Displays center frequency being received (in increments of 10 Hz).

15.1.1.3 Extended functions of the digital terrestrial television broadcast reception-compatible BS/BS broadband CS receiver

- (1) Directional adjustment of the receiving antenna and display of receiving status information

During directional adjustment of the receiving antenna, the receiver must specify the receiving channel using a remote controller, send the received frequency to the terrestrial adapter, acquire receiving-status information regularly from the terrestrial adapter using a READ DESCRIPTOR command, and display the information on receiving status.

Receiving-status information is transmitted as a value for the signal_strength field. By way of example, displayed content can be a “bar representation” in accordance with the receiving-status information (0-255), but the specific method of representation will be left for the product planning.

- (2) About EPG

See ARIB technical documents. Though memory in addition to that for BS-EPG and broadband CS-EPG may become necessary, this will be left for product planning.

- (3) Receiving function based on reception search and Service-ID

In response to a “reception search” command from the remote controller, etc., the receiver must prepare a “frequency table based on Service-ID” by receiving all receivable channels at a reception location using a searching function. The remote controller must possess the ability to direct re-search efforts to handle installation of new stations and new repeater stations. An example of the procedure for a reception search is shown below.

- 1) In response to the “reception search” command, the terrestrial-compatible BS/BS broadband CS receiver displays “Search in Progress (displayed content is arbitrary)”, and a center frequency of the lowest physical channel is set in a terrestrial adapter using the DSIT command.
- 2) A “ready-to-receive (tuning)” status and “receiving-status information” are acquired from the terrestrial adapter by using the READ DESCRIPTOR command. The receiver waits while the “Search in Progress” message is being sent. When the search state is ended and the ready-to-receive state initiated, the receiver forms a “frequency table based on Service-ID (consisting of frequency, Service-ID, the receiving state information, etc.)” and moves to the next frequency. When the unable-to-receive state initiated (i.e., incapable of tuning), the receiver moves to the next frequency.
- 3) The terrestrial-compatible BS/BS broadband CS receiver specifies the next frequency and sets it in the terrestrial adapter using the DSIT command.
- 4) The reception search is conducted in this manner sequentially, and if a frequency with the same network_id as that of the previously received frequency is identified and yields

better receiving status information than the previous frequency, the terrestrial-compatible BS/BS broadband CS receiver must delete part of the former frequency table and replace it with the new part of the frequency table, thus updating the table.

- 5) When the search at the highest frequency ends, the terrestrial-compatible BS/BS broadband CS receiver deactivates the “Search In Process” display and terminates the search operation.

During normal reception, the receiver transmits a received frequency containing a service specified by Service ID to the terrestrial adapter and receives a full TS from the terrestrial adapter. During the “Search in Progress” phase, the receiver must display this message, and if an “unable to receive” status occurs (including cases in which the service in question is halted), the receiver must display “unable to receive” and direct the next selection.

- (4) About memory

Since the digital terrestrial television broadcast receiving function is an addition to the BS digital broadcast receiving function and broadband CS digital broadcast receiving function, it is anticipated that it will require expanded memory; however, this will be left for product planning.

- (5) About the remote controller

The remote controller will be left for the product planning stage, but commonality between the receiving operations for BS digital broadcasting and broadband CS digital broadcasting is required. The receiver should at minimum be able to select between “BS”, “broadband CS” and “terrestrial” when directed by the remote controller, then display the results on-screen. For more information on other functions, refer to “Remote-control function” in Appendix 5.

15.2 Baseband unit

The baseband unit at and downstream of the TS interface must meet, in addition to this ARIB standard, certain other requirements:

- For the narrow-band CS digital broadcast-compatible receiver, ARIB standard B1 and B16; and
- For the digital CATV broadcast-compatible receiver, JCTEA standard STD-007.

Chapter 16: Server-type broadcast receiving function

To allow reception of the "server-type broadcast" defined in the STD-B38 standard specification, receiver specifications such as communication and content accumulation functions to be added to the previously-described receiver functions are defined below.

16.1 Basic configuration of the server-type broadcast receiver

The basic configuration of the "server-type DIRD" for receiving the server-type broadcast defined in STD-B38 is shown in Fig. 16-1.

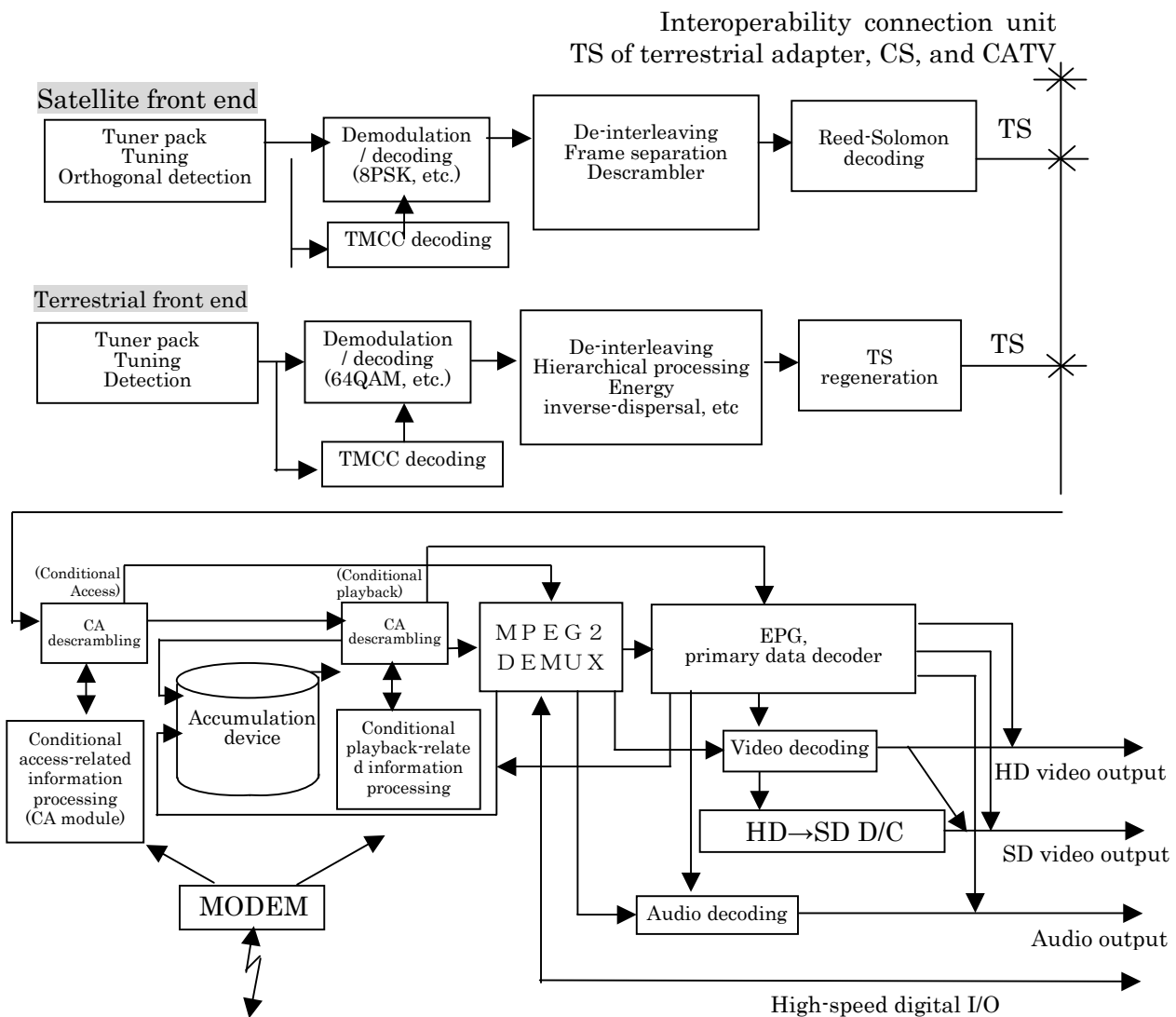

Figure 16-1 Basic configuration of server-type DIRD

16.2 Specifications of server-type broadcast receiver components

16.2.1 Accumulation function

The receiver must have an accumulation function to receive the server-type broadcast defined in STD-B38. It also must have a rights protection function defined in Chapter 17.

16.2.2 Video signal processing and output types

There are two types of video signal accumulation in the server-type broadcast receiver:

- (1) accumulating stream-type video contents to allow real-time viewing;
- (2) other than the case of (1), accumulating video files in accordance with the media type defined in ARIB STD-B24 Part 3.

Sections 6.1.1 and 6.1.2 apply to type (1).

The specification is beyond the scope of this document in type (2).

16.2.3 Audio decoding and output

There are two types of audio signal accumulation in the server-type broadcast receiver:

- (1) Accumulating stream-type audio contents to allow real-time viewing;
- (2) Other than the case of (1), accumulating audio files in accordance with the media type defined in ARIB STD-B24 Part 3.

Sections 6.2.1, 6.2.2, and 6.2.3 apply to type (1).

The specification is beyond the scope of this document in type (2).

16.2.4 Specifications of bidirectional communication function

As protocols with which stream-type contents are referred to, the RTP, RTCP, RSVP, and RTSP protocols are added to the application layers of the following functions: binary transfer HTTP, ISDN-DSU-TA connection protocol B channel, ISDN-DSU-(with built-in TA) connection protocol B channel, protocol for direct connection to Ethernet communication network terminating sets, protocol for Ethernet communication router connection, and protocol for binary transfer data communication using portable phone/PHS (PIAFS).

16.3 Signal processing function of the server-type broadcast receiver

Stream- and file-type contents described in ARIB STD-B25 are received, and after their accumulation, selected contents are played back. The procedures are described below.

16.3.1 Flow of content accumulation

Contents shall be accumulated according to the flowchart of Fig. 16-2.

16.3.2 Flow of selecting accumulated contents

16.3.2.1 Flow of selecting stream-type contents

Accumulated stream-type contents shall be selected according to the flowchart of Fig. 16-3.

16.3.2.2 Flow of selecting file-type contents

Accumulated file-type contents shall be selected according to the flowchart of Fig. 16-4.

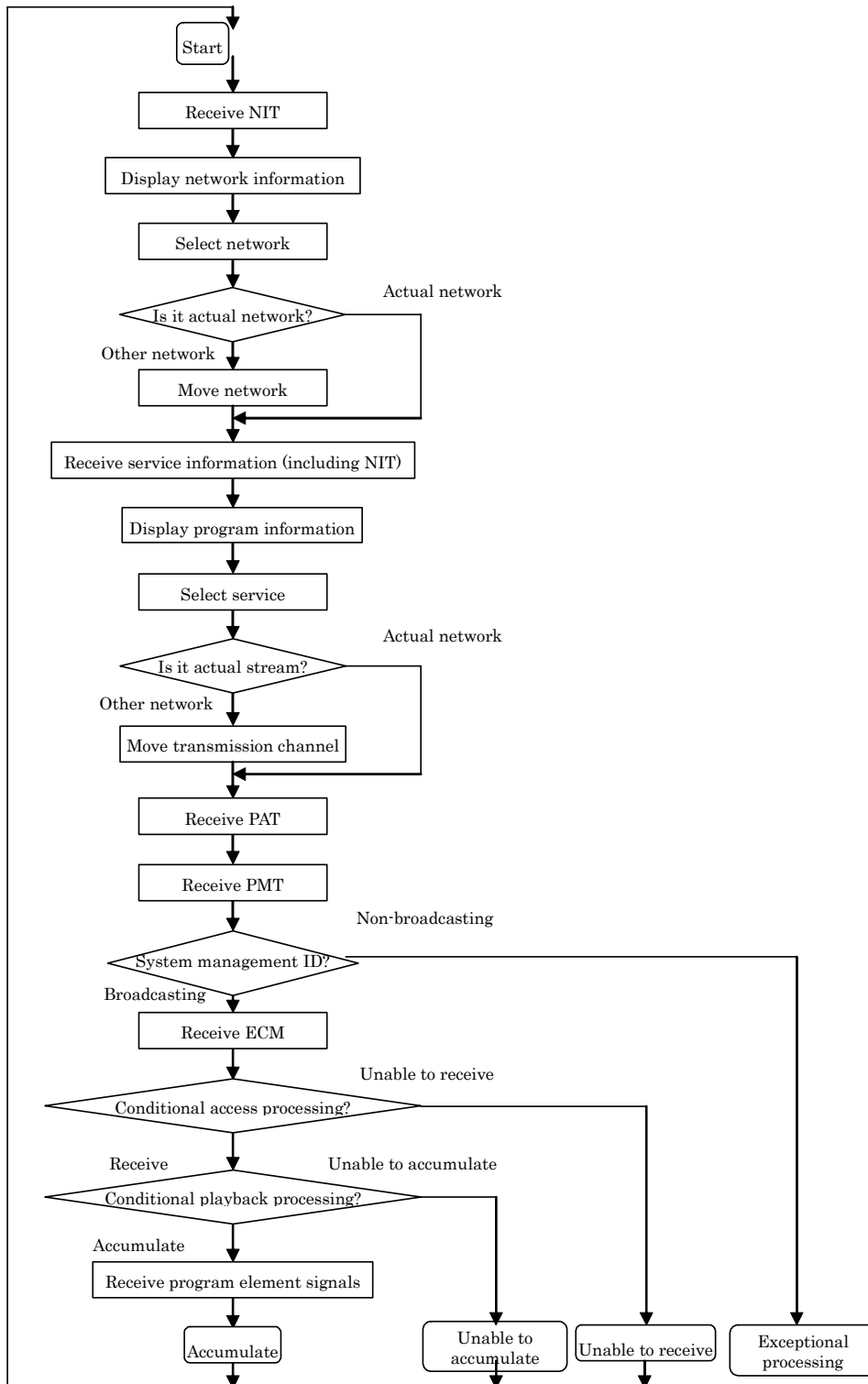

Notes:

- (1) Only the basic flow is described. Branching/shortcut routes can be provided as additional receiver functions.
- (2) When receiving a broadcast containing proper NIT and service information, the flow would not proceed into exceptional processing.
- (3) Exceptional processing includes re-setting to capture the broadcast wave correctly and special processing for non-broadcasting use (uploading of the system management ID, etc.).

Fig. 16-2 Basic flow of accumulating contents

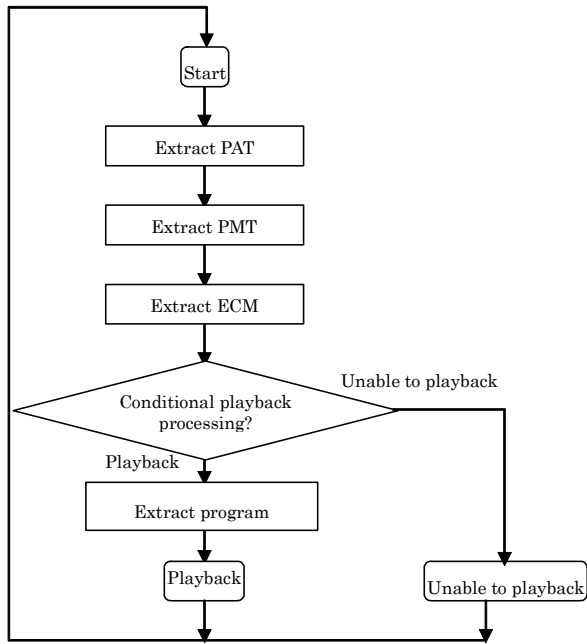

Note:

- (1) Only the basic flow is described. Branching/shortcut routes can be provided as additional receiver functions.

Figure 16-3 Basic flow of selecting stream-type contents

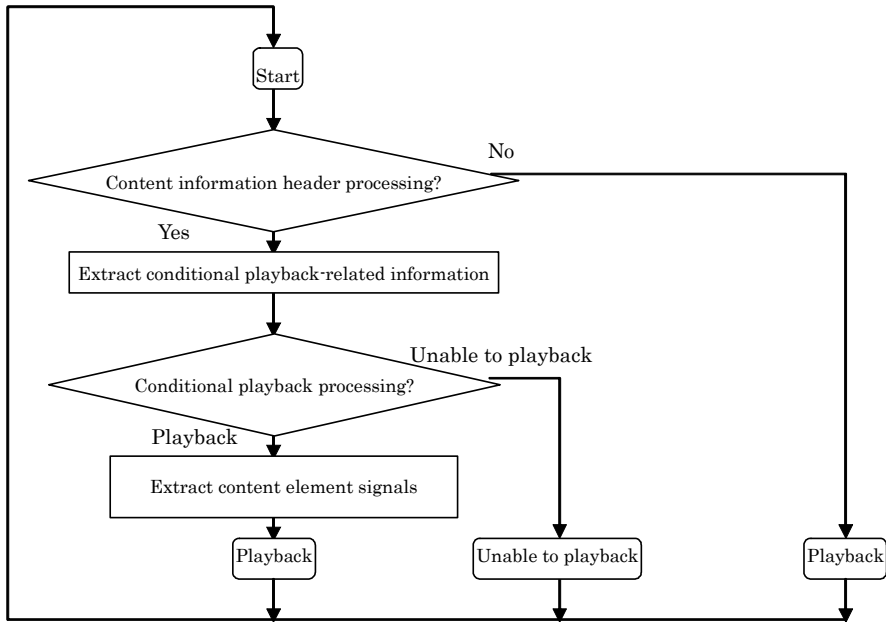

Note:

- (1) Only the basic flow is described. Branching/shortcut routes can be provided as additional receiver functions.

Figure 16-4 Basic flow of selecting file-type contents

Chapter 17: Rights protection function

Technical requirements on rights protection information for contents, etc., and its function were reported by the technical section group of the Telecommunications Council in March and September, 2002. ARIB has been working on standardization basically according to these reports, and the digital copy control descriptor and the content availability descriptor are defined in the STD-B10 standard specification.

The reports of the Telecommunications Council, including future policies on standardization and operational standards, are annexed to this document.

APPENDIX Commentary and Guidelines

Contents

Appendix 1	Method of switching the video format	167
Appendix 2	High-speed digital interface	177
Appendix 3	Downloading function	192
Appendix 4	Down-mix processing in the AAC decoder.....	193
Appendix 5	Making the BS/BS and broadband CS broadcasting receiver compatible with digital terrestrial television broadcasting.....	195
Appendix 6	Receiving antenna system for broadband CS digital broadcasting and notices regarding the system.	218
Appendix 7	Satellite receiving antenna system described in Rec. ITU-R BO.1213.	219
Appendix 8	Desired performance standard of satellite DIRD	220
Appendix 9	Bidirectional communications.....	221
Appendix 10	Performance of the receiver for digital terrestrial television broadcasting.....	238
Appendix 11	Signal processing for different types of server-type broadcast services.....	247
Annex 1	251
6	Technical conditions on rights protection schemes.....	252
7.	Next challenges	266
V.	Results of consultation.....	266

Reference 1	267
Reference 2	274
Annex 2	277
1. Enforcement.....	278
2. Rights protection information	278
3. Maintenance of the rights protection scheme used by receivers	285
4. Protection of meta-data against alteration, and handling of meta-data provided by third parties.....	288
Reference 8	289
1. Purpose and timing of digital watermarking in broadcasting systems	289
2. Verification of effects.....	289
3. Standardization of inserting method of digital watermarks	290
4. On the management of digital watermarking	290

Appendix 1 Method of switching the video format

Described in this section is a method of realizing seamless display, or display that causes the viewer to feel only the slightest sense of incongruity when a format (1080i, 720p, 480p, 480i, etc.) of the video stream is changed to another format for a particular service ID.

Since the signal-processing on the transmitting side is closely related to that on the receiving side in order to achieve seamless display, operation procedures on both the receiving side and transmitting side are described here. Separate descriptions will be given of two different methods on the transmitting side: (A) procedure that can realize completely seamless switching; and (B) a simplified procedure; as well as of desirable methods on the receiving side, each of which corresponds to each procedure described above. Note, however, that methods (A) and (B) are based on the assumption that the transmitting side conducts the operation described below that is recommended by ARIB standard STD-32. Also note that although the description here is of cases in which SDTV is changed to HDTV, in cases involving switching from HDTV to SDTV, switching between SDTVs (480i \longleftrightarrow 480p), and switching between HDTVs (1080i \longleftrightarrow 720p), both the transmitting and receiving sides can conduct similar processing.

In switching between any two video formats, such as SDTV-HDTV, SDTV-SDTV, or HDTV-HDTV, it is recommended that the ES_PIDs of the video streams in different formats always use different numbers before and after switching, and that they be transmitted using the procedure described here. The procedure for switching from SDTV to HDTV is described below.

[Condition]

Any broadcasting station that intends its broadcasts to be displayed seamlessly during switching from an SDTV 3-channel program to an HDTV 1-channel program, or from an HDTV 1-channel program to an SDTV 3-channel program, should transmit as follows:

- The station should transmit the same number of PMTs, each specifying the same service_ID as that of SDTV.
- The station should set ES_PID of HDTV to a value different from those of the PIDs of all components that are being transmitted when transmission of a new PMT is started.
- PMTs of an SDTV program and of an HDTV program each should contain a video-decoding control descriptor.

As an example of a case satisfying these conditions, in this appendix, the values of the service-id and ES-PID for each program are set as follows.

SDTV1 program: service_id = 01 ES_PID = 101 \rightarrow HDTV program: service_id = 01 ES_PID = 104

SDTV2 program: service_id = 02 ES_PID = 102 → HDTV program: service_id = 02 ES_PID = 104

SDTV3 program: service_id = 03 ES_PID = 103 → HDTV program: service_id = 03 ES_PID = 104

Video-decoding control descriptor

Data structure	No. of bits	Mnemonic
video_decode_control_descriptor(){		
descriptor_tag	8	uimsbf
descriptor_length	8	uimsbf
still_picture_flag	1	bslbf
sequence_end_code_flag	1	bslbf
video_encode_format	4	bslbf
reserved	2	bslbf
}		

still_picture_flag: 1: A still picture (MPEG-I frame) is being transmitted.

0: A moving picture is being transmitted.

sequence_end_code_flag: 1: A stream in which sequence_end_code is transmitted

0: A stream in which no sequence_end_code is transmitted

video_encode_format: 0000: 1080p

0001: 1080i

0010: 720p

0011: 480p

0100: 480i

0101: 240p

0110: 120p

0111: reserved

1000–1111: For extension of video_encode_format

reserved 2 bit: For future extension

[A] Operation procedure that can realize completely seamless switching (method of transmitting sequence_end_code)

• Transmitting-side operations

1. Assume the SDTV/HDTV switching time to be time T1. PMT of SDTV should contain video_decode_control_descriptor (sequence_end_code_flag: 1; video_encode_format: 0100(480i), 0011(480p)).
2. For three SDTV encoders and one HDTV encoder, PCRs and PTSs (DTSs) are synchronized, and PCRs are set continuously during switching.
3. Transmission of PMT of an HDTV program (specifying ES_PID = 104) is begun one second (standard time) before switching time T1. PMT of HDTV should contain video_decode_control_descriptor (sequence_end_code_flag: 1; video_encode_format: 0001 (1080i), 0010 (720p)). (Note 1)
4. The transmission of an SDTV stream is ended in the end of GOP just before the switching time, and sequence_end_code is added at the end. (Note 2)

5. At the switching time, the multiplexing of TSs for SDTV is halted and multiplexing of TSs for HDTV started in the multiplexer. It is desirable that sequence_header of HDTV be transmitted as quickly as possible after having been switched to an HDTV stream. The first GOP is “closed GOP”. Null data is multiplexed at a position between sequence_end_code of the SDTV set to be stream and sequence_header_code of the HDTV stream. (Note 2)

(Note 1): Timing for starting transmission of the new PMT

- With free broadcasts only, if the new PMT is transmitted 0.5 seconds or more before program-switching time T1, the receiver can fully respond to the PMT. Since it is common for any transmitting-side operation to be executed on the second, it is standard practice for the new PMT to be transmitted one second before T1. The receiver side is only limited in that it must begin transmitting the new PMT at any time between 0.5 seconds and 2 seconds before T1.
- With pay broadcasts, if many keys must be switched, there may be cases in which transmission of the new ECM must be started more than two seconds before T1, due to the response time of an IC card. However, transmission of the new PMT more than the two seconds before T1 may involve the disadvantage of the picture not appearing for an extended period for viewers who tune in at this timing. Therefore, it is desirable that transmission of the new PMT be performed some time in the interval between 0.5 seconds and 2 seconds before T1, and that the CAS operations be performed in such a way that no problem occurs, even with this timing due to the instrumentation, such as making the keys common, temporal non-scrambling.

(Note 2): When the schedule is controlled in increments of exactly one second in the broadcasting station, the timing of the end of GOP and the timing in increments of one second normally differ due to the length of GOP and the frame/field frequency of 59.94 Hz. As a result, the timing of the end/start of the stream varies to some degree from the control timing. This requires special attention, as the gap between the end of an SDTV stream and the start of an HDTV stream must be sufficiently small to ensure that the decoder buffer on the receiving side will not cause underflow.

• Receiver-side operations

A-1) Case of a seamless-switching-capable receiver

1. The receiver acquires the PMT of a new version.
2. When it is determined from the content of the PMT descriptor that a stream is such that `sequence_end_code` is transmitted due to the switching from SDTV to HDTV, the DEMUX is configured so as to input ES_PID streams of SDTV and HDTV to the AV decoder. Note that two pieces of real data are not input at the same time due to the transmission timing; after transmission of the stream data of SDTV is completed, the stream data of HDTV is stored in the buffer.
3. When the video decoder has acquired `sequence_end_code`, the receiver displays a frozen image and mutes the audio.
4. When the decoder has acquired `sequence_header` of the stream for HDTV, the decoder conducts appropriate decoding with automatic tracking. When the decoder reaches a state that enables the output of normal images and audio, it releases the image-freezing and the audio muting. (If the image is to be displayed in an apparently seamless manner, the HDTV stream must be received immediately after the end of the SDTV stream so that the buffer does not underflow. In this case, the image is not frozen. If the length of time between the end of the SDTV stream and the start of the HDTV stream is not sufficiently small and the buffer underflows as a result, the image transmitted just before `sequence_end_code` is freeze-displayed.)
5. When the decoder has confirmed that the HDTV decoding has begun, it restricts the ES_PIDs that are input into the AV decoder to those for HDTV.

A-II) Case of a seamless-switching-noncapable receiver

1. The receiver acquires the PMT of a new version.
2. When it is determined from the content of the PMT descriptor that the stream is being switched from SDTV to HDTV (regardless of the presence of `sequence_end_code`), the receiver displays a frozen image and mutes the audio.
3. The video decoder stops SDTV decoding.
4. The DEMUX is configured to halt the reception of streams having ES_PID of SDTV, and to input a stream having ES_PID of HDTV into the decoder buffer.
5. The receiver monitors the `sequence_header` monitor register of the video decoder using a host CPU, and waits input of the HDTV stream.
6. When `sequence_header` of the stream for HDTV is acquired, the decoder starts HDTV decoding; when the decoder can output normal images and audio, it releases the image-freezing or display of the black screen and the audio muting.

- **Remarks**

It is desirable that seamless-switching-noncapable receiver models that freeze the image when they receive a new PMT, transmit an image such that flicker is unobservable even when the receiver is in a frozen state, 0.5 seconds (equivalent to the delay at the buffer) or more before the start of transmission of the new PMT.

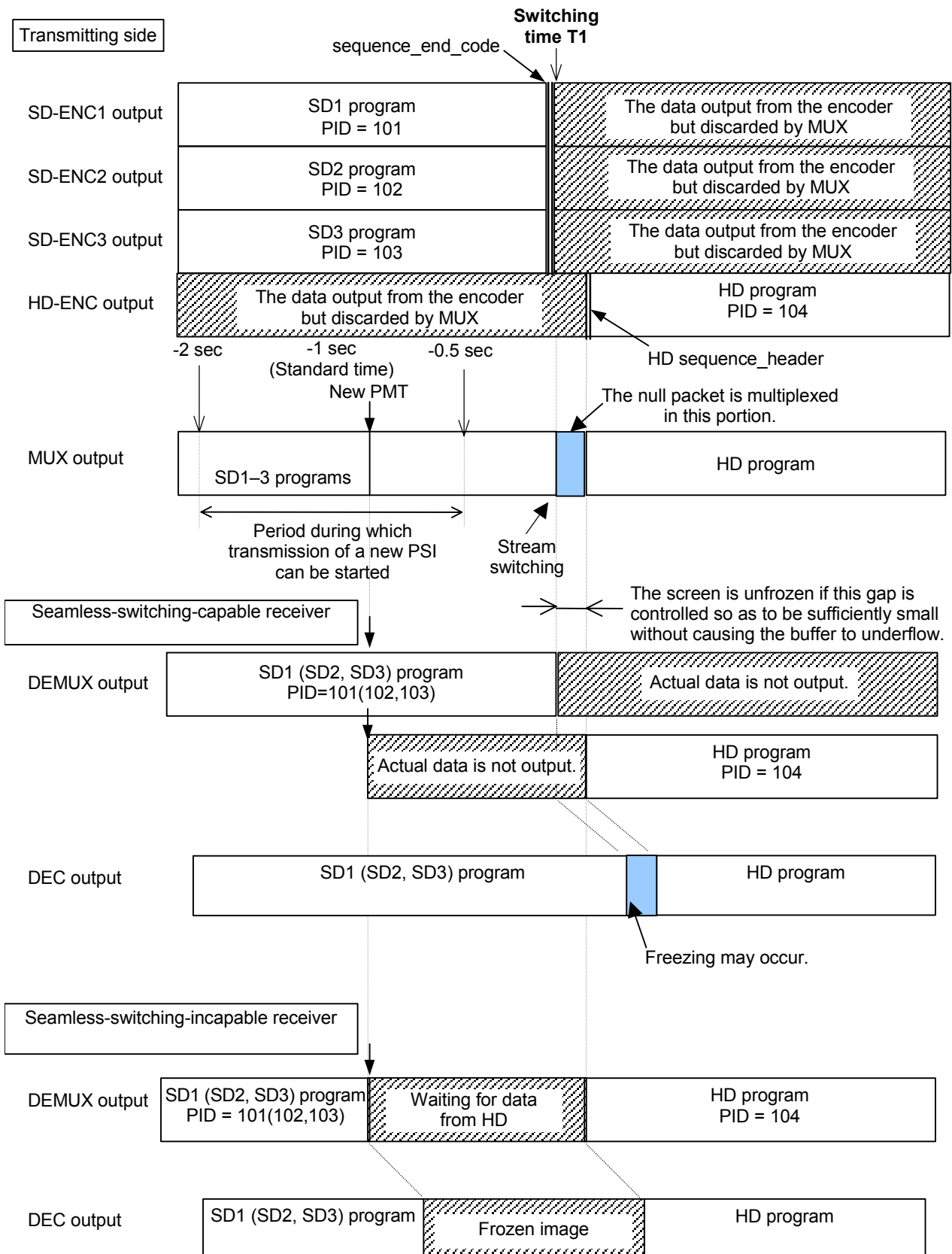

Fig. 1-1 Conceptual diagram of the timing of the transmitting and receiving sides that enables SDTV/HDTV completely seamless switching

[B] Simplified operation procedure for switching SDTV/HDTV (method of not transmitting sequence_end_code)

Here, it is assumed that three SDTV encoders and one HDTV encoder are being operated asynchronously, that PCR shows discontinuity at the time of switching SDTV/HDTV. However, a system in which these encoders are operated in a synchronous manner and PCR maintains continuity is desirable.

• transmitting operations

1. The time one second before an actual HDTV program is started up is considered to be the SDTV/HDTV switching time, T1. PMT of SDTV should contain video_decode_control_descriptor (sequence_end_code_flag: 0; video_encode_format: 0100(480i), 0011(480p)).
2. In the SDTV stream, a black screen or still image that may be freeze-displayed is transmitted 0.5 seconds or more before the scheduled PMT transmission time of an HDTV program, with switching time T1 set as the reference zero time. No audio is transmitted.
3. The encoder for the HDTV stream starts to output an image of a still picture but no audio one second or more before switching time T1.
4. The encoder starts to transmit PMT of the HDTV program (specifying ES_PID = 104) 0.2 seconds to 1 second before switching time T1. PMT of HDTV must contain video_decode_control_descriptor (sequence_end_code_flag: 0; video_encode_format: 0001(1080i), 0010(720p)). (Note 1)
5. At switching time T1, multiplexing of TSs for SDTV is halted and multiplexing of TSs for HDTV is started in the multiplexer. It is desirable that transmission of the SDTV stream end at the end of GOP just before the switching time (sequence_end_code may be added at the end). It is desirable that sequence_header of HDTV be sent as quickly as possible after being switched to the HDTV stream.
6. Until the start time of the HDTV program (1.0 second after the switching time), the image of a still picture and no audio continue to be transmitted. The actual HDTV program starts one second after time T1.

(Note 1): Refer to Note 1 of “[A] Operation procedure that can realize completely seamless switching.”

• Receiver-side operations

If signal processing is conducted in accordance with the method described in A-I in the seamless-switching-capable receiver, the SDTV stream ends abruptly during processing, and the same situation occurs as when there is a major transmission error. As cases are expected to arise in which the receiver is unable to freeze-display the image that was decoded just before the occurrence of the error, and displays a screen with a block error in accordance with the performance of the decoder, it is recommended that the seamless-switching-capable receiver conduct signal processing as follows, in the same manner as the non-capable receiver in cases in which sequence_end_code_flag is 0:

1. The receiver acquires the PMT of a new version is.

2. When it is determined from the content of the PMT descriptor that the stream is being switched from SDTV to the HDTV, the receiver displays a frozen image and mutes the audio.
3. The video decoder stops SDTV decoding.
4. The DEMUX is configured to halt the reception of streams having ES_PID of SDTV, and to input a stream having ES_PID of HDTV into the decoder buffer.
5. The receiver monitors the sequence_header monitor register of the video decoder using a host CPU, and awaits input of the HDTV stream.
6. When sequence_header of the stream for HDTV is acquired, the decoder starts HDTV decoding; when the decoder can output normal images and audio, it releases the image-freezing or display of the black screen and the audio muting.

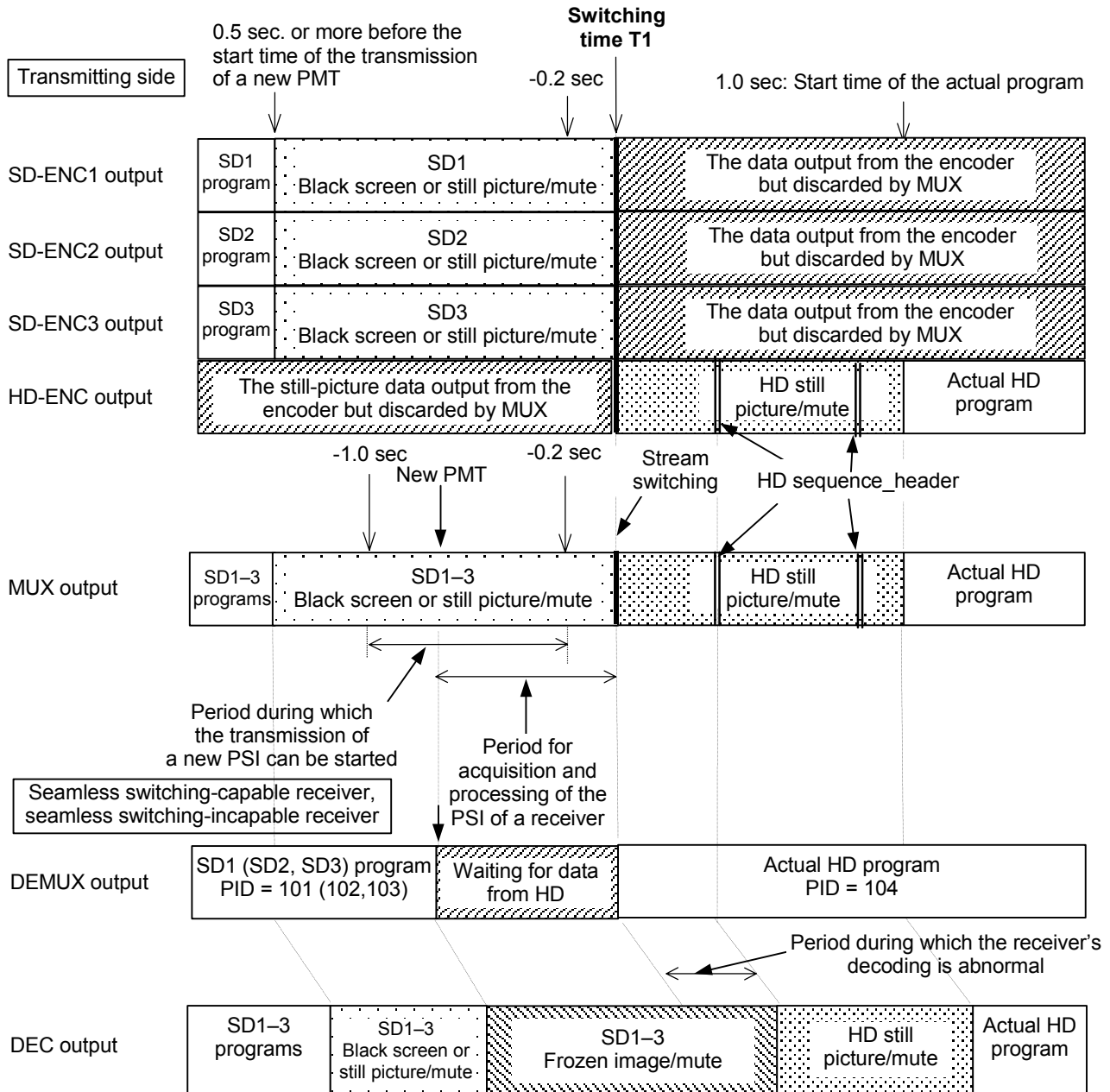

Fig. 1-2 Conceptual diagram of the timing of the transmitting and receiving sides in the simplified method of switching SDTV/HDTV (processing in cases in which sequence_end_code_flag of video_decode_control_descriptor is 0)

Appendix 2 High-speed digital interface

The high-speed digital interface is intended for connection to terminal devices that receive broadcasts other than television broadcasts, such as data broadcasts, as well as for connection to an extended decoder. For this purpose, it is desirable that the standard of the interface be suitable for distribution of the digital stream in the home, and also that it be compatible with the interfaces of future peripheral digital devices. We have also discussed a study of domestic and foreign digital receivers and interfaces that are used in peripheral devices for personal computers and the like.

Interfaces are currently being developed that will enable high-speed, large-capacity transfers of MPEG data, and a technical specification is emerging that will be suited to both the composition of the receiver and a peripheral device to which DIRD is connected.

The selection conditions of the interface specification, containing the following terms; “ease of connection,” “transferability of large data volumes,” “cost-effectiveness of the interface,” “compatibility with personal computers,” “extendibility to home networks,” “bidirectionality,” “openness of technical standards,” “feasibility as a potential standard,” and “connectability between multiple devices,” among others. Further, it has been decided that the receiver will be compatible with the standard of the digital receivers for CS broadcasting (ARIB STD-B1) currently in use. As a result, IEEE1394 (in conformity with IEEE Std 1394-1995) was selected, and IEC61883-1 and 4 were adopted as protocols. It has been decided that the commands and descriptors will conform to the “AV/C Digital-Interface-Command Set Specification” and “AV/C Descriptor Mechanism Specification” deliberated at 1394TA.

In order to enable external devices to control the receiver, Tuner (DIRD) commands have been stipulated. That is, it was determined that the commands will conform to 1394TA, “AV/C Tuner Model and Command” and “Enhancements to the AV/C Broadcast-System Specification—Digital Video Broadcast (DVB)” and support the functions defined in Profile 1: Simplest Tuner without Lists and Selection by DSIT of Enhancements to the AV/C Broadcast-System Specification. The “Tuner Subunit Identifier Descriptor” and “Tuner Status Descriptor” have also been defined as descriptors to be supported. Furthermore, a connection model has been stipulated for connection of the I/O plug of the Tuner Subunit. In addition, a problem about the command (external device command) for programming using EPG of the DIRD has been pointed out. Basically, we consider it possible to ensure interoperability between external devices, due to the fact that DIRD is

equipped with command functions in conformity with the 1394TA command standard for external-device commands. However, it has been determined that the command stipulations for the external devices that are necessary for the EPG programming function will be left as an issue for the future. This decision was made based on the fact that it is difficult to determine the necessary product planning and applications at the present time, and also that programming-related commands have not been stipulated at 1394TA. For reference, examples of commands in a system configuration of DIRD-VCR are described in the attached paper. As the support level of the described commands may differ depending on the product planning, only the commands are enumerated. The commands were formed with reference to 1394TA “AV/C Tape Recorder/Player Subunit Specification.”

With respect to the specifications of the signal of the serial interface, the output signal is specified as an all-transport stream or a partial transport stream before demuxing, as are the input signals from an external device to DIRD. With respect to the signal content, an output all-transport stream shall have the current parallel interface specifications, and an output partial transport stream shall be descrambled. For scrambled output, the problem was pointed out that when individual information related to the contract is put to secondary use (such as recording and reproduction), the contract information or the like undergoes processing; therefore, the scrambled output of the partial transport stream will be left as an issue for the future. However, with respect to scrambled output, DIRD is also equipped with a function for controlling the signal output of the high-speed digital interface on the basis of service information, and the broadcast service carrier can now address the issue of output control from an operational standpoint.

The connector conforming to IEEE Std 1394 shall be a connector with 4 pins or 6 pins.

The IEEE1394 interface was selected as an interface with which content data such as MPEG data and the like could be transferred, and a sufficient copy-protection function is required to ensure copyright protection of the content. It has been decided that a digital-copy-protection scheme for the IEEE1394 interface of DIRD be used as the broadcast service carrier's specifications.

The Internet protocol (IP) network for home use is now being spread remarkably. To make digital broadcasting receivers more attractive and to accelerate their use against this backdrop, it is hoped that such products as home servers on home networks will become more widespread.

Home networks are intended for improving the convenience of users by interconnecting devices at home and exchanging content, control, and other data. The IP interface was therefore selected as a new transmission route for home networks.

Compliance with the Digital Living Network Alliance Home Networked Device Interoperability Guidelines Version 1.0 specified by the Digital Living Network Alliance (DLNA) was assumed for device connection, channel selection, content transmission and other control specifications. In particular, properties to be supported and added for tuner description, which is used for channel selection etc., were specified. As for the character code used for tuner description, rules of conversion from the 8-unit code used for SI information to the UTF-8 used for content directory service (CDS) were specified.

The output signals of the IP interface were specified to be in the form of a partial transport stream, and their transmission format was defined.

Regarding the physical interface, provision of a wiring interface of 10BASE-T, 100BASE-TX, or 1000BASE-T with an 8-pin modular jack (RJ-45) was specified. As for the wireless interface, compliance with the RCR STD-33, ARIB STD-T66, or ARIB STD-T71 was specified as ARIB specifications compatible with 802.11a/b/g.

The transmission protocol shall be the Hypertext Transfer Protocol (HTTP). Use of HTTP/1.1 is recommended in the digital media player (DMP) that receives a stream from the digital broadcasting receiver. The real-time transport protocol (RTP) is to be discussed when the application to be used becomes clear.

As is the case with the IEEE1394 interface, a sufficient capability of copy protection is required in

the IP interface to protect the copyright of content. It has been decided that the digital-copy-protection scheme for the IP interface of DIRD be based on the broadcaster's specifications.

Next, examples of system configurations with a high-speed digital interface (serial interface) are shown in Figs. 1 to 5, and the references of commands in an example of a DIRD–Tape Recorder/Player system configuration are shown in Fig. 6, and in Tables 1 to 4.

Examples of high-speed digital interface (IP interface) system configuration are shown in Figs. 2-7 to 2-9.

Example of IRD (High-Speed Digital Interface) System Configuration

Examples of system configurations of the high-speed digital interface (serial interface) are shown.

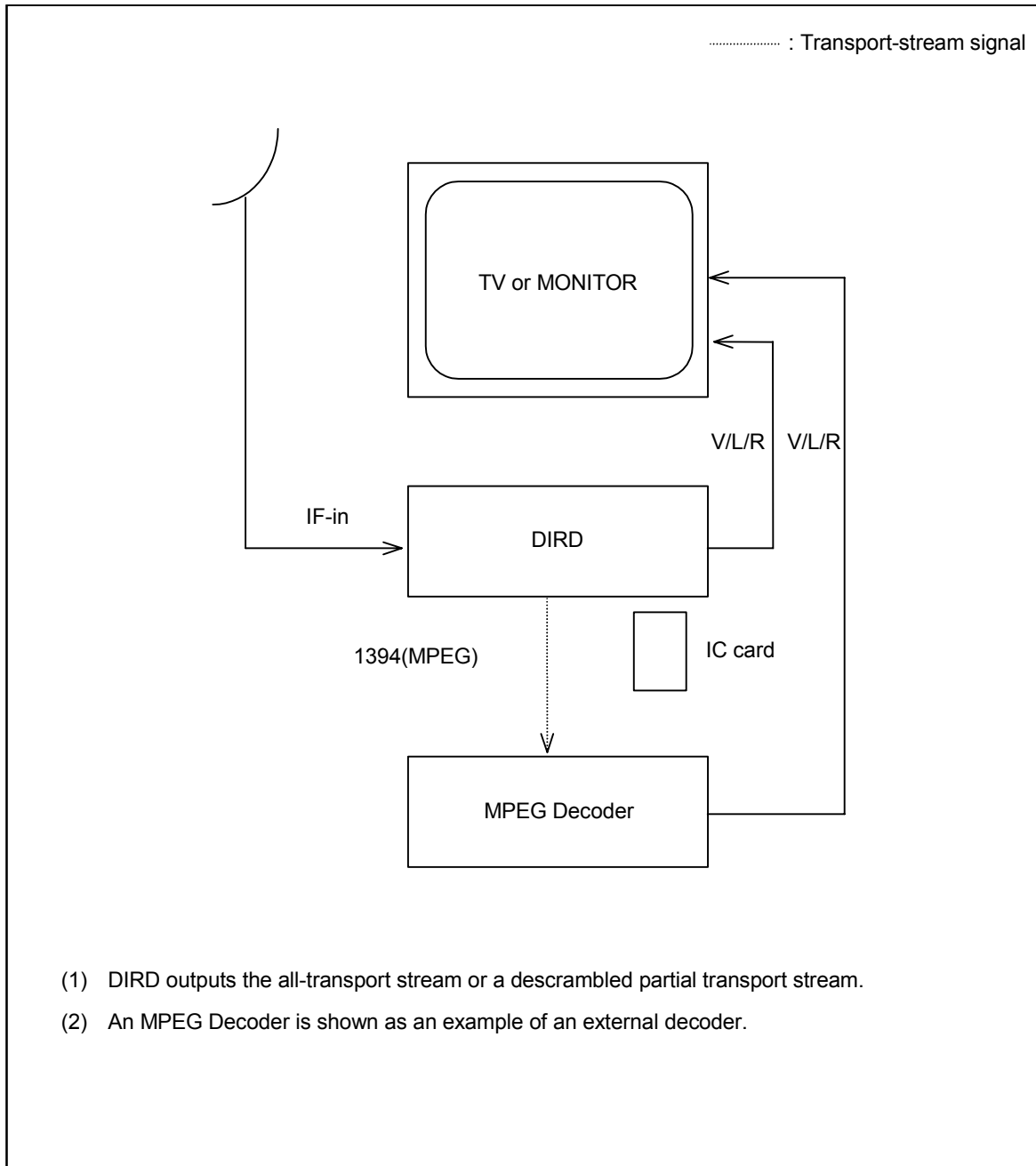

Fig. 2-1 Connection with an external decoder

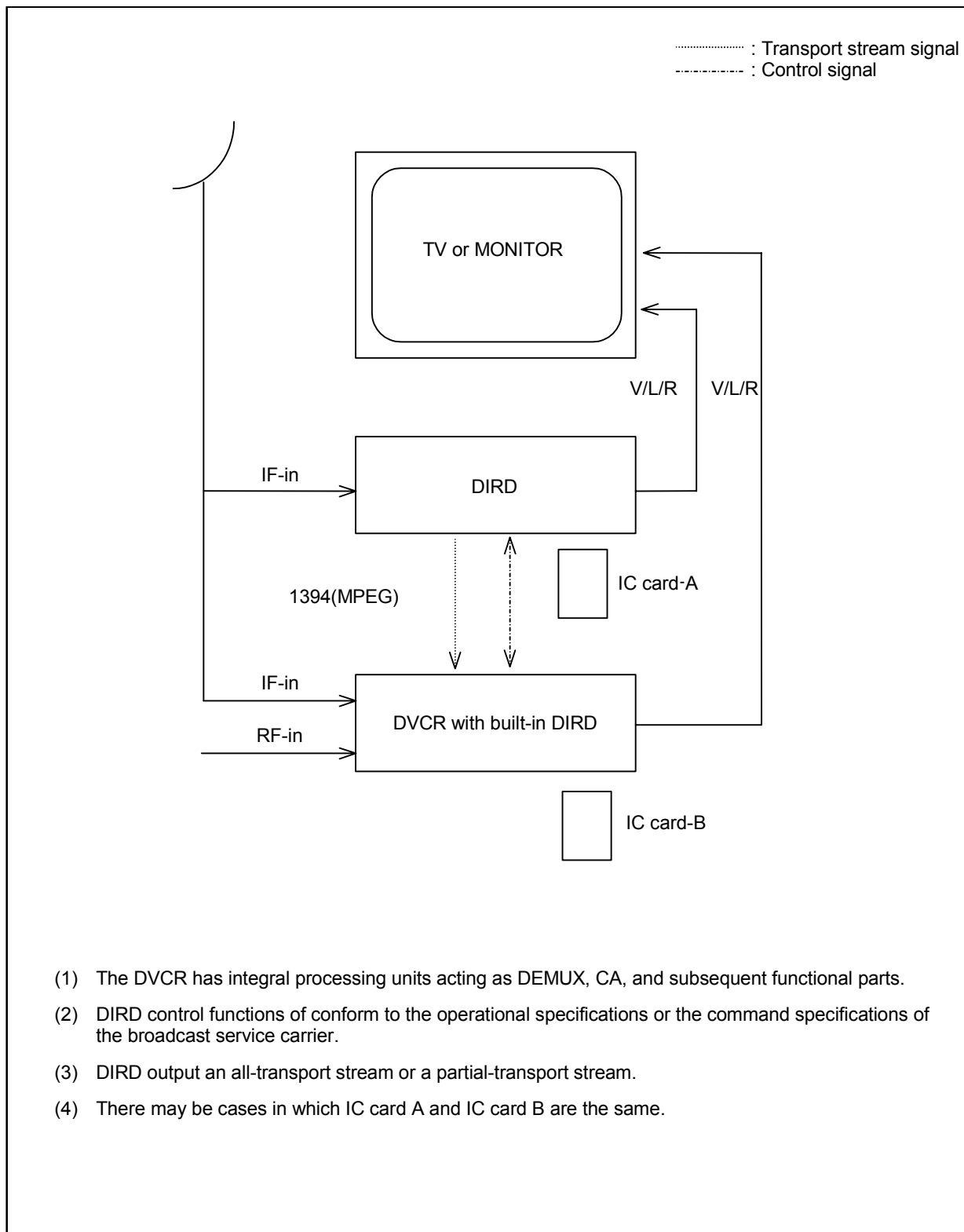

Fig. 2-2 Connection with DVCR (with a reproduction function)

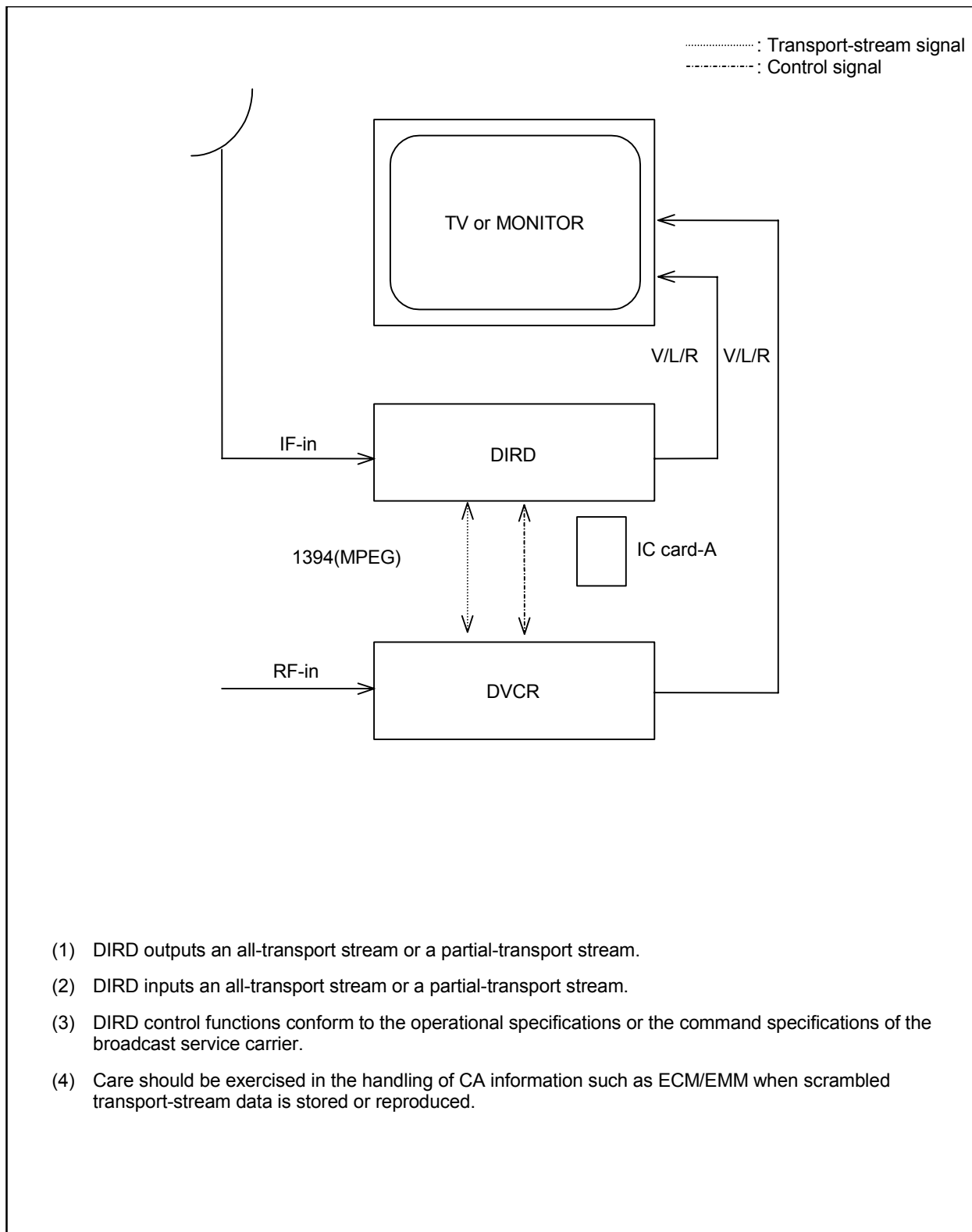

Fig. 2-3 Connection with DVCR (storage)

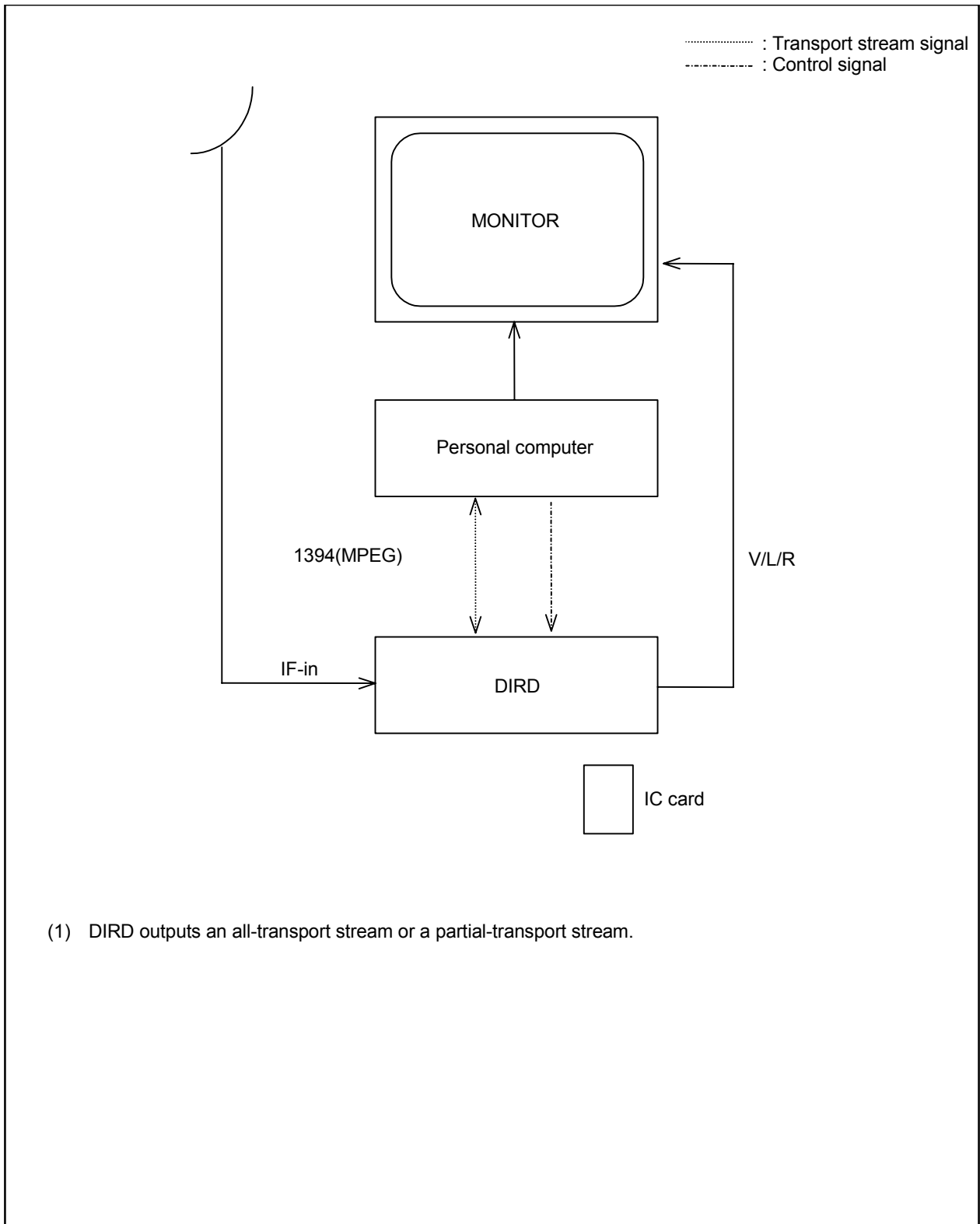

Fig. 2-4 Connection with a personal computer

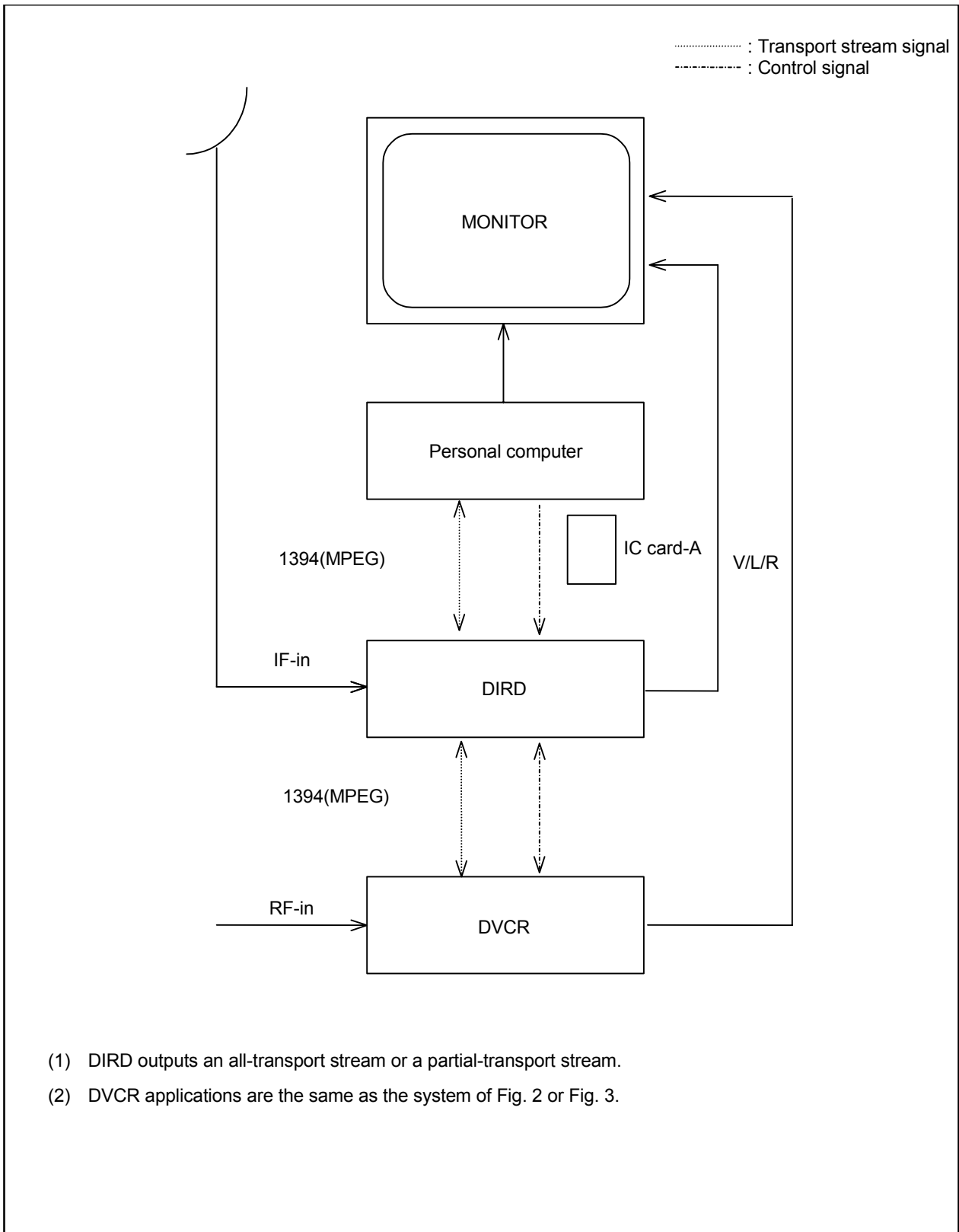

Fig. 2-5 Connection with DVCR + personal-computer system

Attached paper 1: Commands in a DIRD-Tape Recorder/Player connection system (example)

An example of a system configuration of a DIRD–Tape Recorder/Player is shown in Fig. 6. In the following section, which control the Tape Recorder/Player Subunit in the example of the system configuration is shown. These commands must conform to the AV/C Digital-Interface Command Set of the 1394 Trade Association, and refer to 1394TA “AV/C Tape Recorder/Player Subunit Specification Version 2.1 FC1,” as necessary.

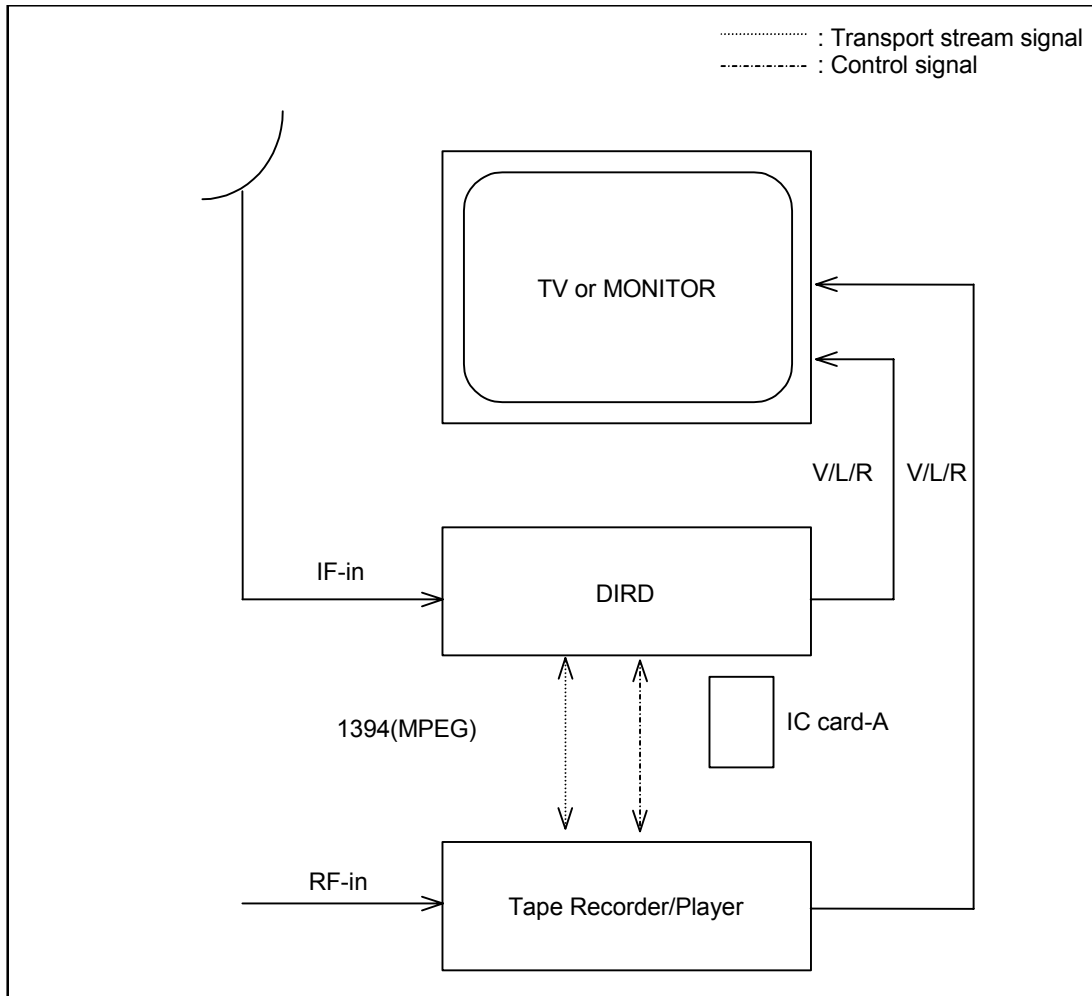

Fig. 2-6

1. Commands that shall be supported by the Tape Recorder/Player Subunit

The receiver can control the basic functions of the Tape Recorder/Player, such as REPRODUCTION, RECORDING, and STOP, through commands that shall be supported by the Tape Recorder/Player Subunit, as described below (refer to Tables 1 and 2).

Table 2-1 Unit commands

Opcode	Value	Command Type	Comments
UNIT INFO	30	STATUS	–
SUBUNIT INFO	31	STATUS	–

Table 2-2 Tape Recorder/Player Subunit commands (mandatory commands)

Opcode	Value	Command Type	Comments
PLAY / FASTEST FORWARD	C3 [3F]	CONTROL	Fast-forward reproduction (CUE)
PLAY / FASTEST REVERSE	C3 [4F]	CONTROL	Rewinding reproduction (REVIEW)
PLAY / FORWARD	C3 [75]	CONTROL	Reproduction (standard speed)
PLAY / FORWARD PAUSE	C3 [7D]	CONTROL	Reproduction pause
RECORD / RECORD	C2 [75]	CONTROL	Recording
RECORD / RECORD PAUSE	C2 [7D]	CONTROL	Recording pause
WIND / STOP	C4 [60]	CONTROL	Stop
WIND / REWIND	C4 [65]	CONTROL	Rewind
WIND / FAST FORWARD	C4 [75]	CONTROL	Fast-forward
INPUT SIGNAL MODE	79	STATUS	Checking the status of the input signal format of the Tape Recorder/Player Subunit
OUTPUT SIGNAL MODE	78	STATUS	Checking the status of the output signal format of the Tape Recorder/Player Subunit
TRANSPORT STATE	D0	STATUS	Checking the transport state of the Tape Recorder/Player (in reproduction, recording, etc.)

[]: operand 0

2. Command for conducting more reliable control

If the receiver uses the commands specified below in addition to the mandatory commands specified in Paragraph 1 above, it is possible to perform recording and reproduction of the program with greater assurance. Note that the support levels described in the comment column are those specified by 1394TA. The commands with support levels of “recommendation” or “option,” some may not be supported by the Tape Recorder/Player Subunit (refer to Tables 3 and 4).

Table 2-3 Common unit and Subunit commands

Opcode	Value	Command Type	Comments
POWER	B2	CONTROL	Power supply control (option)

Table 2-4 Tape Recorder/Player Subunit commands
(commands for conducting more reliable control)

Opcode	Value	Command Type	Comments
TAPE RECORDING FORMAT (D-VHS)	D2	CONTROL	For setting the recording format (option)
TAPE RECORDING FORMAT (D-VHS)	D2	STATUS	For checking the status of the recording format (mandatory in D-VHS)
TAPE PLAYBACK FORMAT (D-VHS)	D3	STATUS	For checking the status of the playback format (mandatory in D-VHS)
INPUT SIGNAL MODE	79	CONTROL	For setting the input-signal format of the Tape Recorder/Player Subunit (option)
TRANSPORT STATE	D0	NOTIFY	For providing notification of changes in the transport state (in reproduction, recording, etc.) of the Tape Recorder/Player Subunit (option)
MEDIUM INFO	DA	STATUS	For acquiring media information (recommended)

The POWER command is used to control the power supply of the Tape Recorder/Player. This command enables the receiver to control the power supply of the Tape Recorder/Player with program recording and other tasks.

The TAPE RECORDING FORMAT/TAPE PLAYBACK FORMAT command is used to set the recording mode of the D-VHS, such as STD/HS/LS.

The INPUT SIGNAL MODE command is used for digital/analog input mode setting of the D-VHS and to set the DV recording mode.

Use of these commands enables the receiver to confirm the recording mode currently set and to set a recording mode suitable for the transmission rate of a program.

The TRANSPORT STATE (NOTIFY) command is used to provide notification of changes in the transport state of the Tape Recorder/Player Subunit. This command enables the receiver to recognize the occurrence of a change in the transport state of the Tape Recorder/Player Subunit. For example, it enables the receiver to recognize that the transport state of Tape Recorder/Player Subunit has changed from RECORDING to STOP because the tape has reached its end. Note that the TRANSPORT STATE (STATUS) command (required command) should be used to confirm the transport state after the change has occurred.

The MEDIUM INFO (STATUS) command is used to acquire information on the currently-inserted cassette. The information of media contained in the cassette includes its general type (DVCR/VHS/8 mm, etc.) and specific type (if it is a VHS type, whether it is S-VHS/D-VHS, etc.), as well as the write protection state. This command allows the receiver to confirm the state of the cassette (whether it is in the record-enabled state) when the receiver issues instructions to perform recording by issuing a RECORD command.

Examples of high-speed digital interface (IP interface) system configuration are presented.

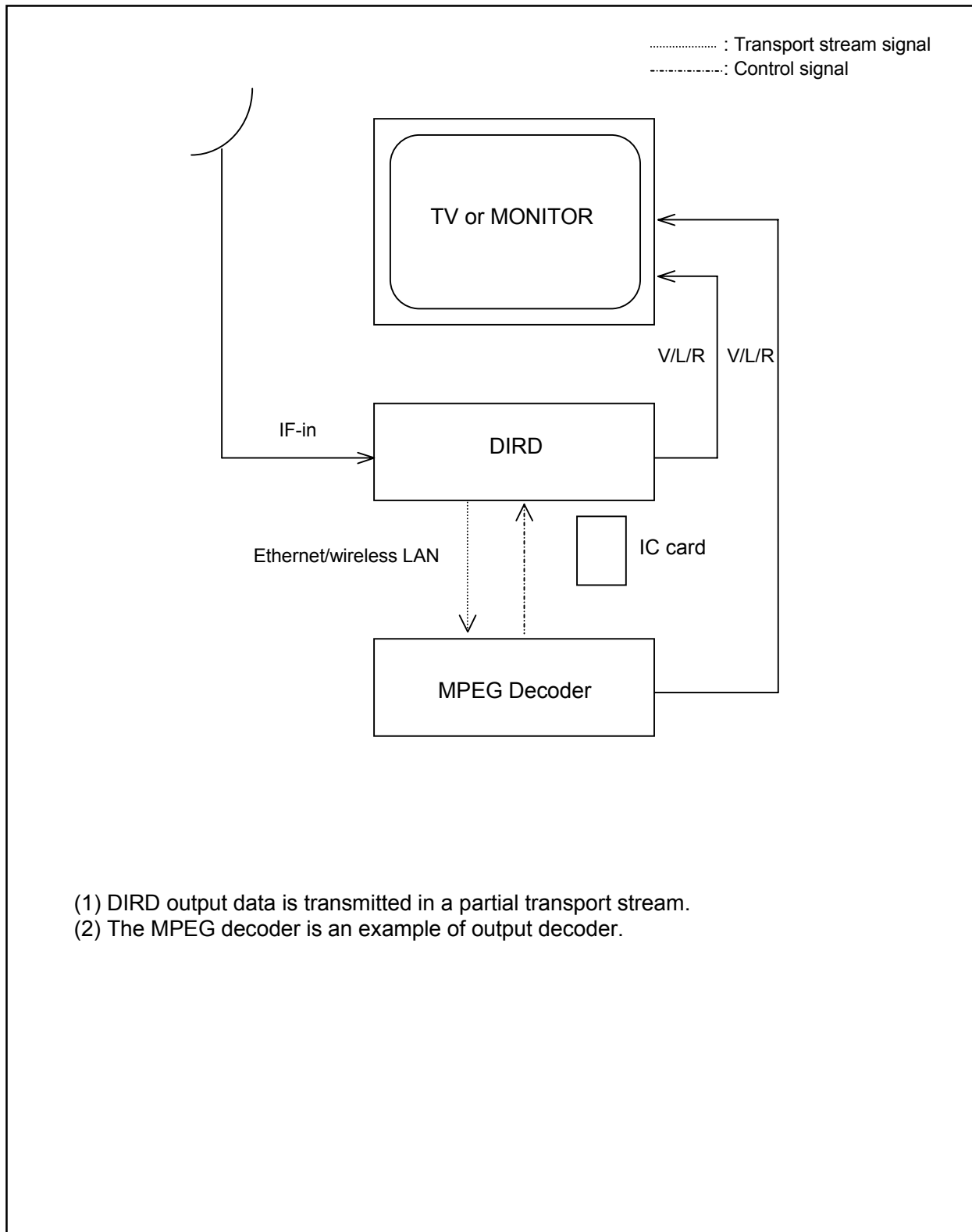

Fig. 2-7 Output decoder connection

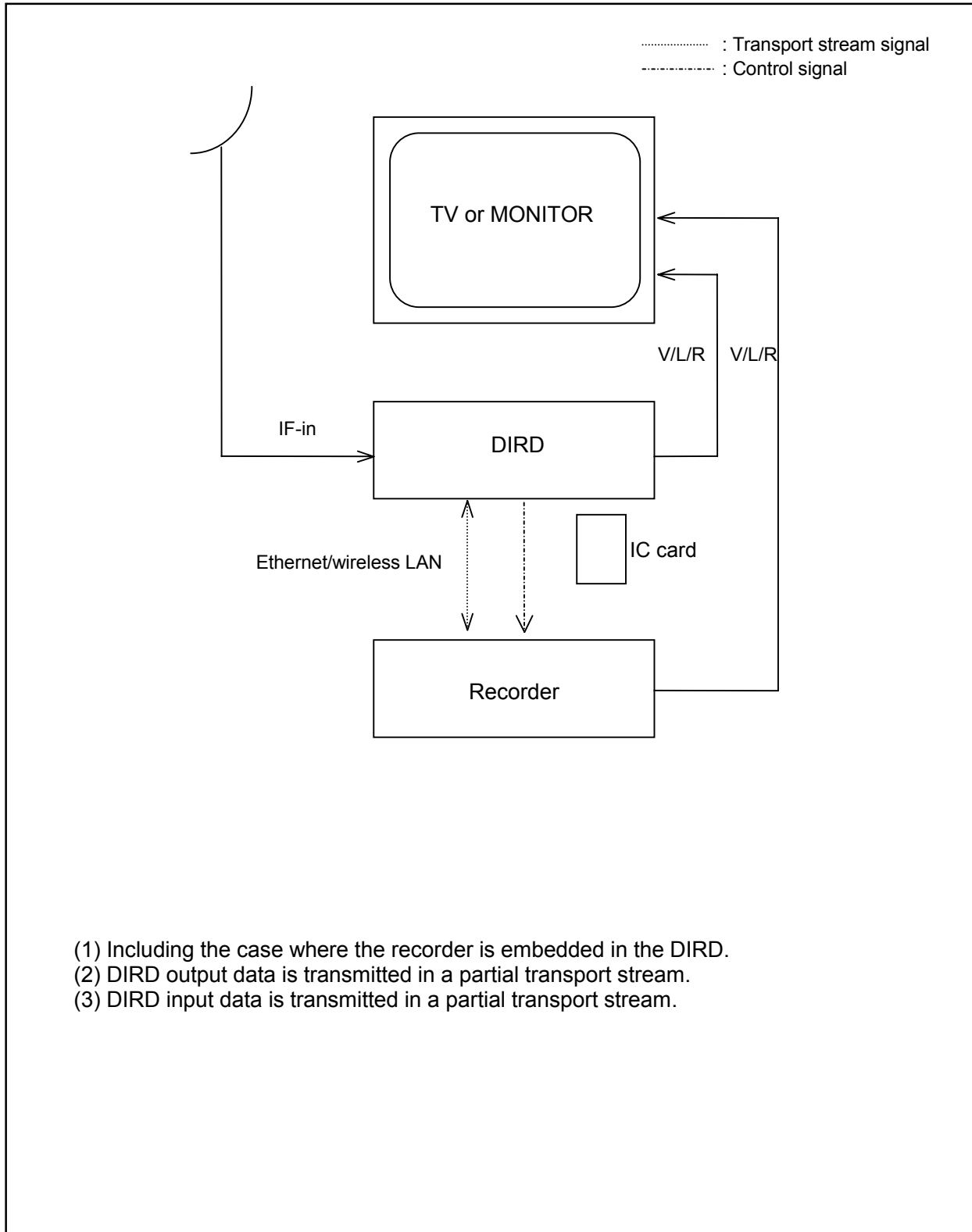

Fig. 2-8 Recorder connection 1 (control of recorder from DIRD)

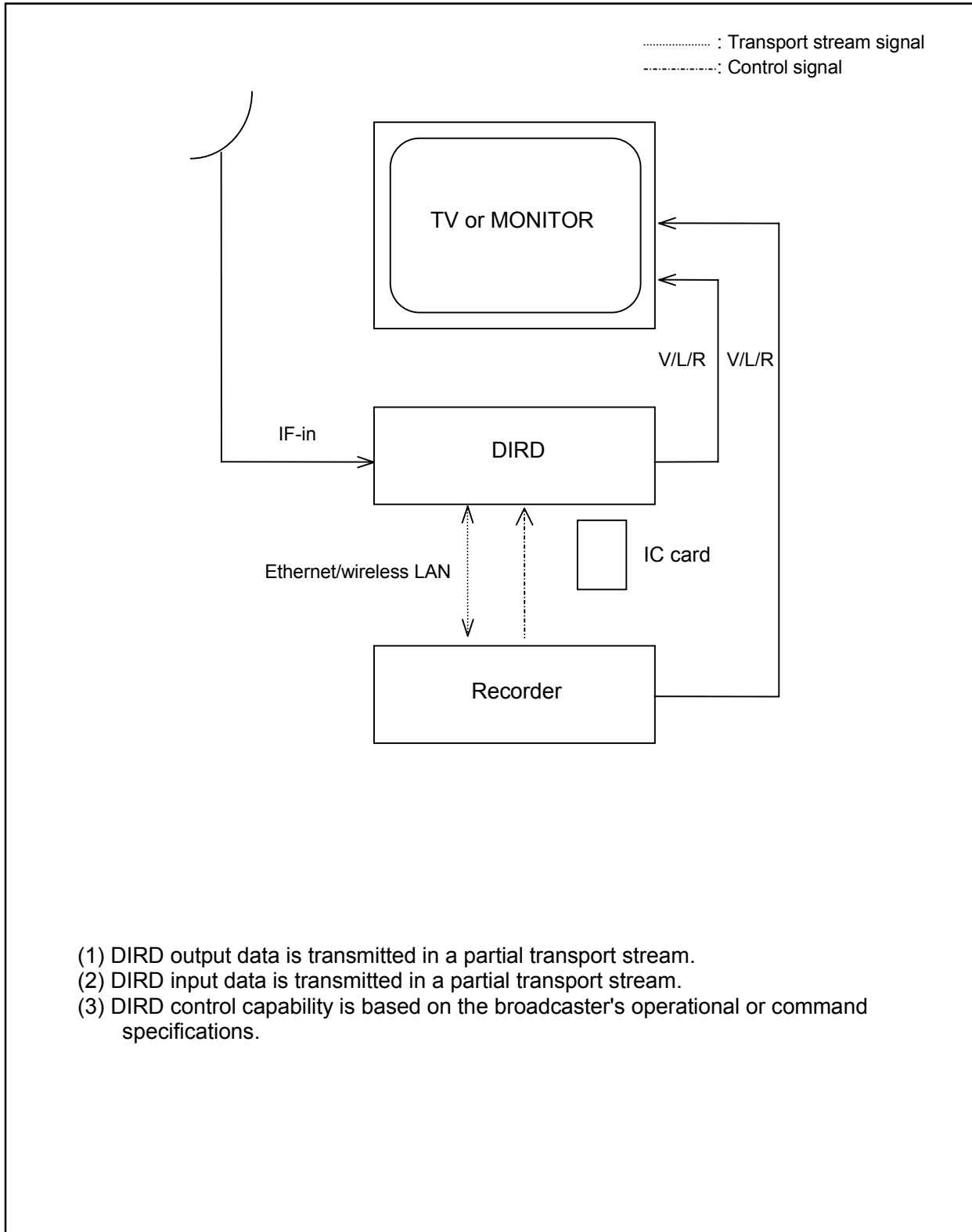

Fig. 2-9 Recorder connection 2 (control of DIRD from recorder)

Appendix 3 Downloading function

(Appendix 3 is only available in the Japanese version.)

Appendix 4 Down-mix processing in the AAC decoder

A down-mixing equation to avoid bit overflow for the AAC decoder is described in Clause 3.3.8.3 "Matrix-mixdown process" of the ISO/IEC 13818-7 standard. However, when the equation is used to down mix a 5-channel program to stereo audio in a 2-channel stereo playback system, the difference in the sound levels of stereo audio generated by down mixing 2- and 5-channel programs becomes significant. Unlike the case of DVD playback in which active adjustment by the user can be expected, volume adjustment for each program by the user is difficult to expect in the case of broadcast reception. For broadcast receivers, therefore, a down-mixing equation to minimize the volume difference is required instead of the ISO/IEC equation. To find a way to easily ensure that the stereophonic audio of a 2-channel stereophonic program and the stereophonic audio generated through the down-mix processing of a multi-channel stereophonic program can be made to have virtually the same loudness, the values of down-mix coefficients were examined, and it has come to describe $a = 0.707 (= 1/\sqrt{2})$ in Clause 6.2.1. A short history of this description is given below.

- Requirements
 - (1) Dynamic range: The bits must be used effectively.
 - (2) Overflow: The probability of the occurrence of overflow must be low.
 - (3) Uniformity of loudness: There must be little discrepancy in loudness between the reception of a 2-ch stereophonic program and the reception of a 5-ch stereophonic program using a 2-ch stereophonic receiver.
- Conformability of the adoption of $a = 0.707(1/\sqrt{2})$ to the above requirements
 - (1) Effective use of the dynamic range

Assuming $a = 0.707$, when 5 channels of L, R, C, Sl, and Sr are added with mutually independent signals each having a root-mean-square value of -18 dB (for example, independent white noise), Lt and Rt each take a root-mean-square value of -18 dB. Therefore, the dynamic range is properly used for general program audio signals.

* If in-phase 1-kHz signals of -18 dB are used as signals to be added, Lt and Rt each become -12.4 dB.
 - (2) Overflow
 - To guarantee that the audio of each channel is free from overflow in any case, the value must be $a = 1/(1 + 0.707 + 0.707) = 0.414$ or less. However, this setting causes a decrease in the level of the normal program audio, with higher-order bits going virtually unused.
 - In the case of $a = 0.707$, when high-level, in-phase signals are added to 5 channels simultaneously, Lt and Rt suffer overflow. However, such a situation is an extremely unlikely event in actual program audio.
 - In the case of $a = 1$, overflow occurs more frequently, and subjectively audible distortion may be generated.
 - If the overflow is rare, adoption of a coding scheme in which clipping occurs in the waveform in the event of overflow (i.e., a non-folding scheme) will prevent significant distortion of the audio.

(3) Difference in loudness between programs of different audio forms

In the case of $a = 0.707$, the listening level decreases by 3 dB. However, in the production of programs, the audio is recorded with a reference level set for each channel, whether 2-channel or 5-channel audio. Therefore, we conclude that this reduced listening levels within a permissible range.

- Conclusion

Although not all requirements can be satisfied, it is thought that $a = 0.707(1/\sqrt{2})$ is almost appropriate.

Appendix 5 Making the BS/BS and broadband CS broadcasting receiver compatible with digital terrestrial television broadcasting

1. Rating for interoperability and for the interface and terrestrial adapter

It is an object of this standardization to enable viewers to receive basic digital terrestrial television broadcasting in the future using a digital terrestrial television broadcasting-compatible BS/BS and broadband CS digital receiver, which is expected to penetrate the market even before the start of digital terrestrial television broadcasting, simply by connecting the terrestrial adapter. Fixed reception and mobile reception are expected to be developed for digital terrestrial television broadcasts but in terms of compatibility with BS/BS and broadband CS digital broadcast reception, fixed reception is assumed.

In the standardization of digital broadcasting in Japan, it has been a basic policy that “the information source coding unit must be media-transversal.” In addition, in the standardization of digital terrestrial television broadcasting, examinations have been conducted based on the standards of BS/BS and broadband CS digital broadcasting. Therefore, in this compatibility standard, we have also confirmed that “The information source decoding unit for digital terrestrial broadcasting was basically the same as that for BS/BS and broadband CS digital broadcast reception.” On this basis, we conducted an examination to determine in which part of the receiving function the interoperability interface should be placed, considering various interface points ranging from a “full TS interface” and a “partial TS interface” to a “baseband interface of moving picture, audio, and data after decoding.” We have adopted the “full TS interface” based on the assumption that “the selected interface must permit receivers already equipped with BS/BS and broadband CS digital receiver’s functions to receive digital terrestrial television broadcasts,” as uncertainties remain regarding some aspects of digital terrestrial television broadcasting service. As a result of this decision, digital terrestrial television broadcasting-compatible BS/BS and broadband CS digital broadcast receivers must be equipped in advance with a connection unit to the terrestrial adapter, and a receiving function for the digital terrestrial television broadcasting. For information on the terrestrial adapter, refer to Chapter 5, Chapter 15, and Appendix 10.

2. Functions and control of terrestrial adapters

For information on the functions and control of the terrestrial adapter, refer to Chapter 5, Chapter 15, and Appendix 10. However, some of the requirements for the interface design must be as

follows:

- 1) The terrestrial adapter conducts frequency fine-tuning to correct the frequency drift of its own local oscillator and in accordance with received frequency information from the terrestrial-compatible BS/BS and broadband CS digital receiver, and receives signals at this frequency. If the parameters of this frequency are stored in advance in a “received-frequency-parameter table” in the terrestrial adapter, the adapter attempts to receive signals using the reception parameters stored in the table. When reception is possible as with the parameters, the terrestrial adapter transmits the received full TS together with the “ready-to-receive” status and the “receiving-status information” to the terrestrial-compatible BS/BS and broadband CS digital receiver. If the parameters corresponding to this frequency are not stored in the table, or when reception is not possible using the parameters in the table, the terrestrial adapter attempts to search this frequency using sequentially altered parameters of the mode and guard interval. During this search, in response to the acquisition of the tuner status information from the terrestrial-compatible BS/BS and broadband CS digital receiver, the terrestrial adapter responds with the “Search in Process” status. When reception is possible using a certain combination of parameters, the terrestrial adapter stores the parameters and the frequency in the “received-frequency-parameter table,” and transmits the full TS to the terrestrial-compatible BS/BS and broadband CS digital receiver. Further, in response to acquisition of the tuner status information from the terrestrial-compatible BS/BS and broadband CS digital receiver, the terrestrial adapter responds with the “ready-to-receive” status and the “receiving-status information.” When reception is impossible even after searching using parameters, the terrestrial adapter responds with the “unable-to-receive” status and “receiving-status information” in response to the acquisition of tuner status information from the ground-compatible BS/BS and broadband CS digital receiver. The TS must not be transmitted.

For more information on the parameters, refer to ARIB technical documents.

- 2) In accordance with a request from the terrestrial-compatible BS/BS and broadband CS digital receiver, the terrestrial adapter sends “receiving-status information” to the terrestrial-compatible BS/BS and broadband CS digital receiver.
- 3) When the “emergency alert broadcasting startup flag” of the TMCC information is set to ON, the terrestrial adapter indicates the existence of the emergency information with its buzzer and LED display.

3. Commands and other operations at the interface

- (1) Tuning and reception search

It has been decided that the tuning and reception search operations instructed to adapter by the terrestrial-compatible BS/BS and broadband CS digital receiver will be performed using the commands standardized thus far to ensure compatibility. In the tuning operation, the terrestrial-compatible BS/BS and broadband CS digital receiver must transmit the received frequency to the terrestrial adapter, and the terrestrial adapter must perform tuning at the received frequency independently, with the mode, the guard interval, etc. being altered sequentially. It has been decided that the terrestrial-compatible BS/BS and broadband CS digital receiver will perform the reception search operation using the tuning operation of the terrestrial adapter, since a reception search start command has not been standardized. The method is described in the main body and in Appendix 5, Clause 2.

- (2) Commands

For the DSIT command for transmission from the terrestrial-compatible BS/BS and broadband CS digital receiver to the terrestrial adapter, the Tuner Status Descriptor shall be used to recognize the receiving status of the terrestrial adapter, and the Tuner Subunit

Identifier Descriptor shall be used to enable the terrestrial-compatible BS/BS and broadband CS digital receiver to recognize the terrestrial adapter.

For the detailed information, refer to Section 11 in Appendix 5.

(3) Receiving-status information

The terrestrial adapter must send receiving-status information to the terrestrial-compatible BS/BS and broadband CS digital receiver, which must then be displayed by the receiver. The receiving-status information must be transmitted as “signal_strength” information from the terrestrial adapter to the terrestrial-compatible BS/BS and broadband CS digital receiver, and then be displayed in the form of a bar graph or the like by the terrestrial-compatible BS/BS and broadband CS digital receiver, as shown in the example in the main body. For more information on “signal_strength”, refer to Section 11 in Appendix 5.

(4) Establishing connection and TS output

Point-to-Point Connection between the terrestrial adapter and the common use receiver shall be established from the terrestrial-compatible BS/BS and broadband CS digital receiver side and not from the terrestrial adapter side. In addition, the terrestrial adapter shall not use Broadcast-out Connection.

The terrestrial adapter does not output full TS when it only has Point-to-Point Connection. It outputs full TS when it makes tuning with the tuning command (DSIT) issued after establishing the connection. Therefore, full TS is not output in the case where the tuning is made with the tuning command issued to the terrestrial adapter and then Point-to-Point Connection is established.

(5) Copy protection

Adequate copy protection for copyrights on content is required when data is transferred from the terrestrial adapter to the terrestrial-compatible BS/BS and broadband CS digital receiver. It has been decided that the copy-protection scheme specified in this appendix will serve as the broadcast service carrier’s specifications.

(6) Example of high-speed digital interface system configuration

The example of high-speed digital interface system configuration in connection between the terrestrial-compatible BS/BS and broadband CS digital receiver and the terrestrial adapter is shown below.

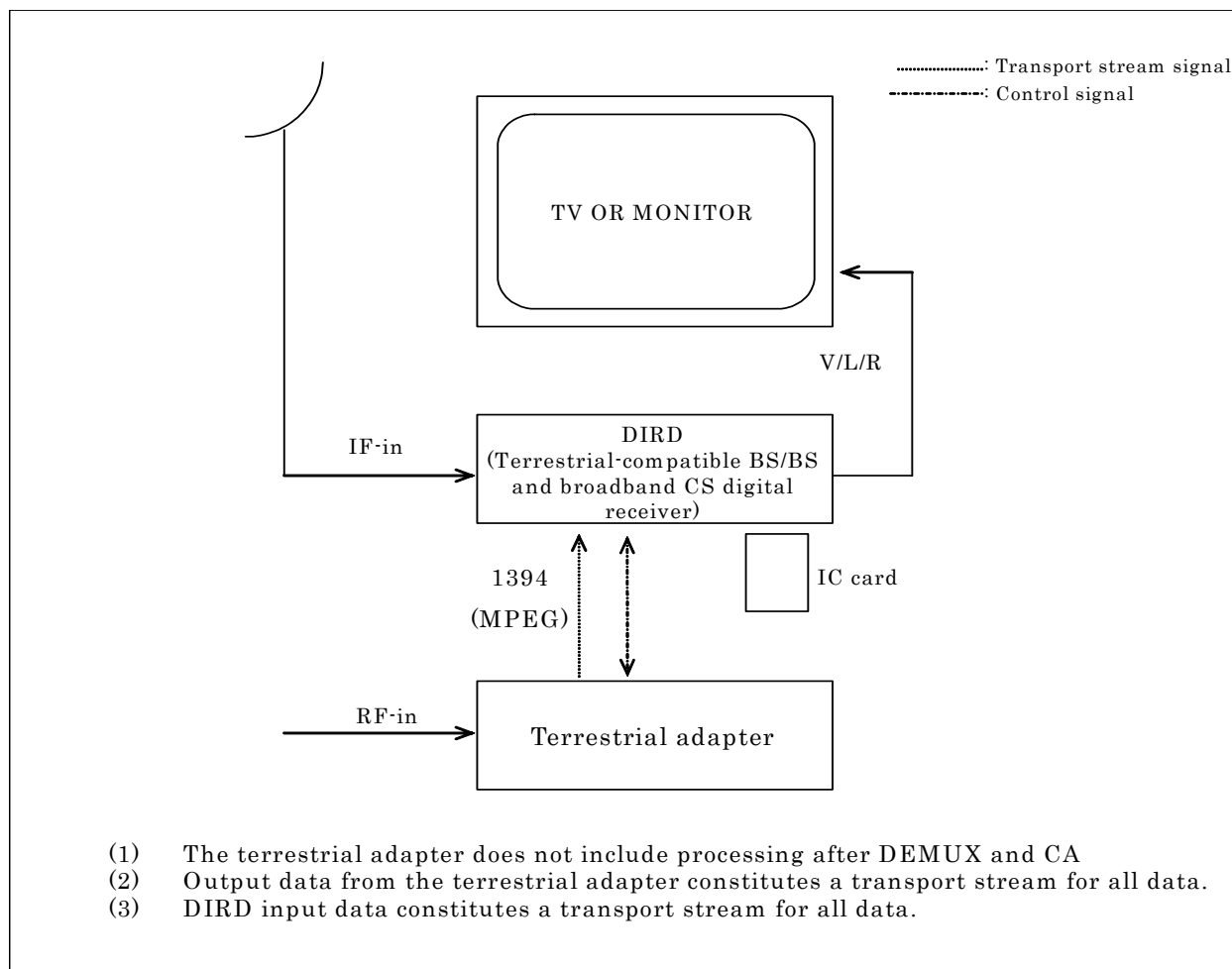

Fig. 5-1 Terrestrial adapter connection

4. EPG, service_id, network_id, etc.

(1) EPG

For the detailed information on EPG, refer to ARIB technical documents. The scanning method for SI information, EPG composition method, display method, EPG functions, and the like are left to product planning of the terrestrial-compatible BS/BS and broadband CS digital receiver.

(2) Assignment of a service_id

Refer to ARIB technical documents.

(3) Assignment of a Network ID and operation of NIT

Refer to ARIB technical documents.

5. Half-rate audio

The “half-rate audio” has been proposed in the field of digital terrestrial television broadcasting. It was decided that it was not a requirement that the terrestrial-compatible BS/BS and broadband CS digital receiver be equipped with half-rate audio.

6. Transmission of TMCC information

The necessity of the “emergency alert broadcasting startup flag” and an “indicator for switching transmission parameters” was examined for the transmission of TMCC information. IEEE1394 provides standards for neither, so if either or both are necessary, new standardization is required. Since the transmission of the flag to the terrestrial-compatible BS/BS and broadband CS digital receiver is unnecessary provided that the terrestrial-compatible BS/BS and broadband CS digital receiver is not ON or for other reasons, we have concluded for the “emergency alert broadcasting startup flag” that a scheme in which a change in this flag from OFF to ON in the terrestrial adapter triggers the operation of the buzzer or the LED to so notify the viewer was preferable. Therefore, the transmission of this flag through the interface is not particularly defined. For the “indicator for switching transmission parameters,” we acknowledge that its use on the terrestrial-compatible BS/BS and broadband CS receiving side is useful, however, its transmission through the interface is not particularly defined, since it is not deemed as a required level of the standard for the terrestrial-compatible BS/BS and broadband CS digital receiver.

7. Received frequency

The center frequencies of channels transmitted from the terrestrial-compatible BS/BS and broadband CS digital receiver to the terrestrial adapter are center frequencies of the analog television channel plan, plus 1/7MHz.

8. Remote-control function

Details of the remote controller are left to those in charge of product planning. However, the remote controller should have the following functions:

- 1) It should be possible to set each of the channels received through the reception search to a remote control button, be deleted therefrom, and be changed as desired.
- 2) It should be possible to make a repeated reception search.
- 3) It should be possible to make directional adjustments of the antenna and a received channel.

9. Example of the flow of frequency scanning in the reception search

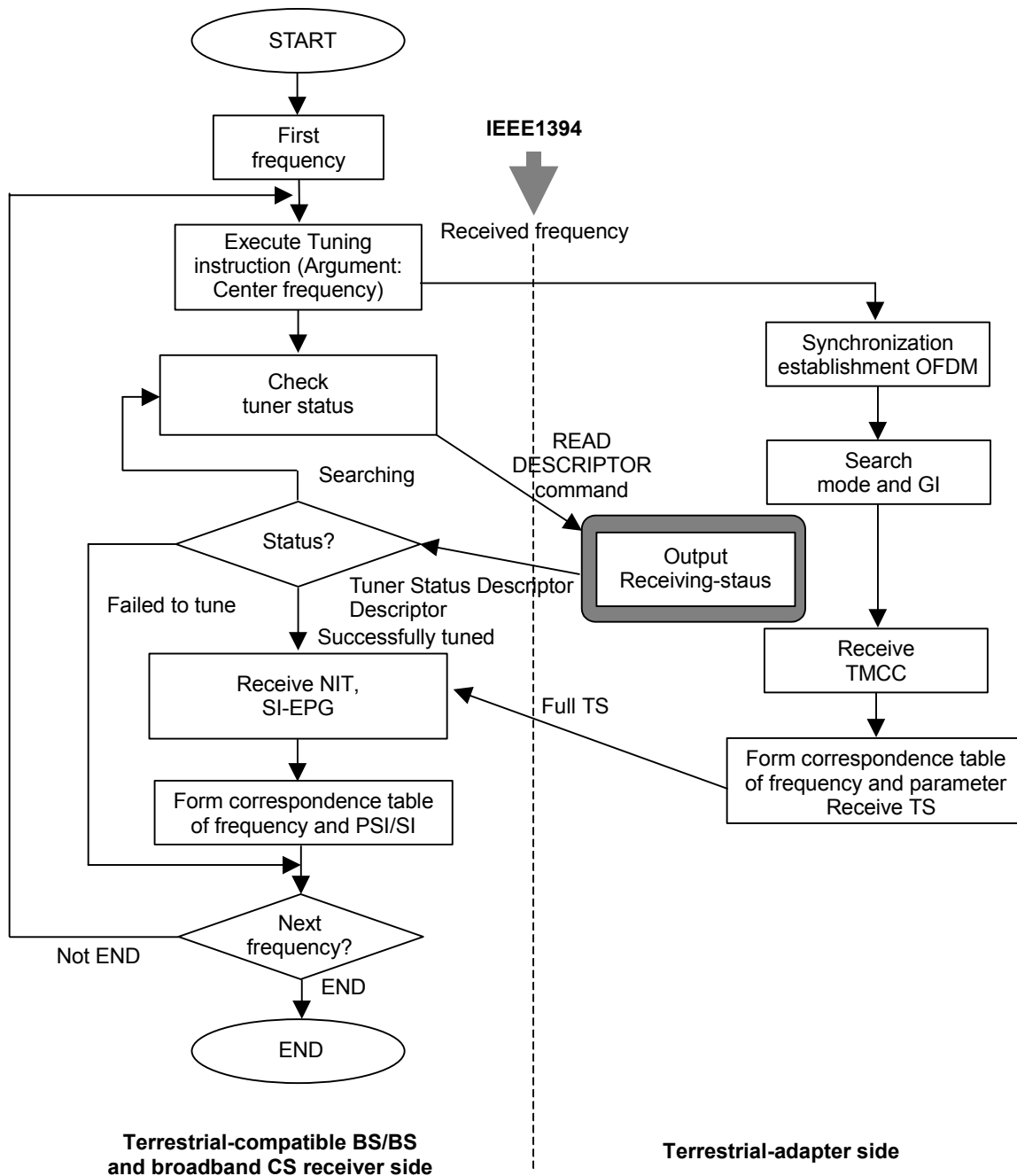

Fig. 5-2 Example of the flow of frequency scanning in the reception search

10. Parameter information to be accumulated by the terrestrial-compatible BS/BS and broadband CS digital receiver and by the terrestrial adapter

Table 5-1 Parameter information to be accumulated by the terrestrial-compatible BS/BS and broadband CS digital receiver and by the terrestrial adapter

Parameter	Terrestrial-compatible receiver	Terrestrial adapter	Remarks
Frequency	○	○	Center frequency (including offset)
Receiving-status information	○		signal_strength
Mode		○	
Guard interval		○	
NIT	○		network_id/version_number/service_id for each frequency that can be received (all that were contained)
SI-EPG	○		Collection and storage of each station's SI through full-frequency scanning

11. Descriptor, command, and tuner model of terrestrial adapter

Terrestrial adapters are equipped with the following features of AV/C Tuner Subunit described in 1394 Trade Association (hereinafter referred to as “1394TA”).

Specifications of Tuner Subunit in 1394TA comply with AV/C Digital Interface Command Set General Specification Version4.1 (hereinafter referred to as “AV/C General”), AV/C Descriptor Mechanism Specification Version1.0 (hereinafter referred to as “AV/C Descriptor”), AV/C Tuner Model and Command Set Version2.0 (hereinafter referred to as ”AV/C Tuner”), AV/C Tuner Broadcast System Specification-Digital Video Broadcast (DVB) Version1.0 (hereinafter referred to as “Tuner DVB”), and Enhancements to the AV/C Broadcast System Specification-Digital Video Broadcast (DVB) Version1.0 (hereinafter referred to as “Enhancements Tuner DVB”), and support features defined in the Profile 1: The Simplest Tuner Without Lists and Selection by DSIT of the Enhancements Tuner DVB.

(1) Descriptor

The terrestrial adapter compliant with Profile1 of Enhancements Tuner DVB must support two descriptors shown in Table 5-2 which are defined in the AV/C General, AV/C Descriptor and AV/C Tuner.

For the detailed information of Tuner Subunit Identifier Descriptor, refer to the AV/C General and AV/C Tuner.

For the detailed information of Tuner Status Descriptor, refer to the AV/C Tuner.

Table 5-2 Mandatory descriptors

Descriptor	descriptor_type	Description	Support
Tuner Subunit Identifier Descriptor	0x00	Shows capability/features of Tuner Subunit	mandatory
Tuner Status Descriptor	0x80	Shows status of Tuner Subunit	mandatory

Structure of each descriptor is shown below.

Tuner Subunit Identifier Descriptor

The structure of Tuner Subunit Identifier Descriptor shall be as shown in Table 5-3. The basic structure is defined in the AV/C Descriptor and the structure of subunit_dependent_information is defined in the AV/C Tuner.

Table 5-3 Tuner Subunit Identifier Descriptor

Structure	Number of bits	Value ^(Note 1)
descriptor length	16	0x002B
generation_ID	8	0x02
size_of_list_ID	8	0x02
size_of_object_ID	8	0x06
size_of_object_position	8	0x02
number_of_root_object_lists	16	0x0000
subunit_dependent_length	16	0x0021
subunit_dependent_information{		
number_of_systems	8	0x01
for (i=0; i<number_of_systems; i++) {		
system[i]_specification{		
specification_length	16	0x001E
system_id	8	0x20

implementation_profile_id	8	0x10
number_of_subsystem_labels	8	0x01
for (j=0; j<number_of_system_labels; j++) {		
subsystem_label_length	8	0x09
subsystem_label[1-9]	72	JPNTBAD PT
}		
multiplex_preferred_selection_flags	16	[0x4000]
service_preferred_selection_flags	8	[0x00]
number_of_antennas	8	0x01
for (k=0; k<number_of_antennas; k++) {		
antenna[k]_specification {		
mobile, movable, reserved(3bits),	8	0x03
transport(3bits)		
external_input_plug_number	8	[0x9D]
system_specific_antenna_range_specification_length	16	0x0007
system_specific_antenna_range_specification		
selection_attribute_range_specification_for_A{		
list_flag, range_flag, size_of_attribute(s)	8	0x00
}		
selection_attribute_range_specification_for_B{		
list_flag, range_flag, size_of_attribute(s)	8	0x00
}		
selection_attribute_range_specification_for_C{		
list_flag, range_flag, size_of_attribute(s)	8	0x00
}		
selection_attribute_range_specification_for_D{		
list_flag, range_flag, size_of_attribute(s)	8	0x00
}		
selection_attribute_range_specification_for_E{		
list_flag, range_flag, size_of_attribute(s)	8	0x00
}		
selection_attribute_range_specification_for_F{		
list_flag, range_flag, size_of_attribute(s)	8	0x00
}		
selection_attribute_range_specification_for_G{		
list_flag, range_flag, size_of_attribute(s)	8	0x00
}		
}		
}		
system_specific_info_length	8	0x01
system_specific_info{		
DVB_specification_version	8	0x11
}		
}		
}		
manufacturer_dependent_length	16	0x0000

Note 1: Values to be set are described for fields in which a fixed value is specified and for fields in which a value can be set optionally but a default value is defined (default values are indicated in []). See also the following description of fields.

- generation_ID

This field is defined in the AV/C Descriptor and the value shall be as shown in Table 5-4.

Table 5-4 generation_ID

Value	Meaning
0x02	The descriptor structure compliant with the AV/C Descriptor (AV/C Descriptor Mechanism Specification Version 1.0)

- size_of_list_ID, size_of_object_position

These fields are defined in the AV/C Tuner and the values shall be as shown respectively in Table 5-5.

Table 5-5 size_of_list_ID, size_of_object_position

Field	Value
size_of_list_ID	0x02
size_of_object_position	0x02

- size_of_object_ID

The value of size_of_object_ID shall be determined by the service object ID restriction (6 bytes) defined in the Tuner DVB as shown in Table 5-6.

Table 5-6 size_of_object_ID

Field	Value
size_of_object_ID	0x06

- number_of_root_object_lists

The value of number_of_root_object_lists shall be set to 0x0000 because Profile 1 has in principle no object list.

- number_of_systems

The value of number_of systems shall be set to 0x01 because the terrestrial adapter can receive

only digital terrestrial television broadcasting.

- system_id

This field is defined in the AV/C Tuner and the value shall be as shown in Table 5-7.

Table 5-7 system_id

Value	Meaning
0x20	Broadcasting system compliant with DVB

- implementation_profile_id

This field indicates Profile 1 and is defined in the Enhancements Tuner DVB. The value shall be as shown in Table 5-8.

Table 5-8 implementation_profile_id

Value	Meaning
0x10	Profile1: The Simplest Tuner without Lists and Selection by DSIT

- number_of_subsystem_labels

The value of number_of system_labels shall be set to 0x01 that indicates the number of digital terrestrial television broadcasting networks because the terrestrial adapter can receive only digital terrestrial television broadcasting.

Table 5-9 number_of_subsystem_labels

Field	Value
number_of_subsystem_labels	0x01

- subsystem_label

This field lists broadcasting systems that can be received and describes them in 9-character label length with ASCII alphanumeric code characters. For the terrestrial adapter, the value shall be

set as shown in Table 5-10.

Table 5-10 subsystem_label

Value	Meaning
JPNTBADPT	Terrestrial adapter

- multiplex/service_preferred_selection_flags

The default values of multiplex_preferred_selection_flags and service_preferred_selection_flags shall be as shown respectively in Table 5-11 because the terrestrial adapter supports the tuning by specifying center frequency (DSIT command).

Table 5-11 multiplex/service_preferred_selection_flags

Field	Value
multiplex_preferred_selection_flags	[0x4000]
service_preferred_selection_flags	[0x00]

- number_of_antennas

The AV/C model of terrestrial adapters shall be regarded to have only one antenna, i.e., switching of antennas shall not be performed.

Table 5-12 number_of_antennas

Field	Value
number_of_antennas	0x01

- transport

For digital terrestrial television broadcasting, the “transport” is defined in the AV/C Tuner and the value shall be as shown in Table 5-13.

Table 5-13 transport

Value	Meaning
011	Terrestrial broadcasting

- external_input_plug_number

Because the use of 0x9D is recommended for external_input_plug_number in digital terrestrial

television broadcast receivers, it is also recommended to use the same value (0x9D) in the terrestrial adapter.

- system_specific_info

In this field, DVB_specification_version defined in the Enhancements Tuner DVB shall be described.

The value of system_specific_info shall be as shown in Table 5-14.

Table 5-14 system_specific_info

Field	Value
system_specific_info	0x11

Tuner Status Descriptor

The structure of Tuner Status Descriptor in the terrestrial adapter shall be as shown in Table 5-15.

The basic structure is defined in the AV/C Tuner.

Table 5-15 Tuner Status Descriptor

Structure	Number of bits	Value ^(Note1)
descriptor_length	16	0x0021
general_tuner_status{		
antenna_input_info_length	8	0x0C
antenna_input_info{		
active_system_id	8	0x20
searching, moving, no_RF, reserved(5bits)	8	
input(=0), selected_antenna(7bits)	8	0x00
antenna_general_system_info{		
BER	32	[0x00000000 0]
signal_strength	8	
raster_frequency(2bits)	2	0x2
RF_frequency(22bits)	22	0x000000
manufacturer_dependent_info_length	8	0x00
}		
}		
system_specific_mux_selection_length	8	0x0C
system_specific_mux_selection{		
system_specific_mux_attributes_valid_flags{		
reserved_filed, center_frequency, bandwidth,	8	[0x40]
constellation, hierarchy_info, code_rate_HP_stream,		
}		

code_rate_LP_stream, guard_interval network_id, transmission_mode, other_frequency_flag, reserved(5bits) }	8	[0x00]
system_specific_mux_selection_attributes{ currently_available, selected, reserved(6bits) center_frequency	8	[0x40]
bandwidth(3bits), reserved(5bits)	32	[0x00000000]
constellation(2bits), hierarchy_info(3bits), code_rate_HP_stream(3bits)	8	[0x00]
code_rate_LP_stream(3bits), guard_interval(2bits), transmission_mode(2bits), other_frequency_flag	8	[0x00]
network_id }	16	[0x0000]
demux_input_info_length demux_input_info{}	8	0x00
number_of_source_plugs for (i=0; i<number_of_source_plugs; i++) { source_plug_status[i]{ source_plug_number	8	0x01
Attributes	8	0x00
input, reserved(7bits)	8	0x00
data_status_length	8	0x00
data_status{}		
info_type_status_length	8	0x00
info_type_status{}		
}		
}		

Note 1: Values are described for fields in which a fixed value is specified and for fields in which a value can be set optionally but a default value is defined (default values are indicated in []). See also the following description of fields.

- active_system_id

The value of system_id corresponding to the broadcasting system to be received shall be set in this field.

For the setting of active_system_id, refer to the system_ID of the Tuner Subunit Identifier Descriptor.

- searching, moving, no_RF

The functions of "searching", "moving", and "no_RF" flags are described in Table 5-16.

The value (status) of no_RF indicates the front-end lock status of the terrestrial adapter; no_RF=1

when the adapter is unlocked or not operated.

When searching=1, the terrestrial-compatible BS/BS broadband CS receiver shall regard currently_available and signal_strength as invalid.

Table 5-16 Indication flags of antenna_input_info

Flag	Meaning of flag
searching	Under tuning operation = 1
moving	Always "0" (antenna of terrestrial adapter is fixed type)
no_RF	No antenna signal input (including the period in which no wave is transmitted) = 1

- antenna_input_info

The antenna destination plug shall always be connected, and antenna_input_info shall always exist.

- selected_antenna

This indicates the index value of antenna_specification specified by the Tuner Subunit Identifier Descriptor of the connected antenna.

In the terrestrial adapters, selected_antenna has a value of "0x00" because only one antenna_specification is defined.

- antenna_general_system_info

The value of each field of antenna_general_system_info is shown in Table 5-17.

When the "searching" or "no_RF" is set to "1", each field of antenna_general_system_info shall be invalid.

Values may be set and output for devices that use BER.

Any of received C/N, received electric-field strength, and BER information can be used for the value of signal_strength; higher values, up to 255, indicate better reception status.

Table 5-17 antenna_general_system_info

antenna_general_system_info	Value	Description
BER (bit error rate)	[0x00000000]	Set the default value as left or a correct value
signal_strength		Reception status of the terrestrial

		adapter (0~255) (the maximum value should be 255)
{raster_frequency(2bits), RF_frequency(22bits)}	0x800000	For the terrestrial adapter, this field shall not be used and the value as left shall be set. However, raster_frequency=0x2 (4kHz) shall be fixed.
manufacturer_dependent_info_length	0x00	This field shall not be used for the terrestrial adapter.

- raster_frequency

Allocation of the value of raster_frequency is defined in the Tuner DVB. In the terrestrial adapter, raster_frequency shall be fixed to 0x2 (4 kHz) for the antenna_general_input_info of the Tuner Status Descriptor, and the RF_frequency shall not be used.

- system_specific_multiplex_attributes_valid_flags

The status of the terrestrial adapter is set for attributes that are set to "1" by the multiplex/service_preferred_selection_flags of the Tuner Subunit Identifier Descriptor and for attributes that can be dealt with by the terrestrial adapter using the DSIT command. Examples of setting are shown in Table 5-18.

Attributes that are set to "0" by system_specific_multiplex_attributes_valid_flags shall be regarded as invalid.

Table 5-18 system_specific_multiplex_attributes_valid_flags

Field	Value
reserved_filed, center_frequency, bandwidth, constellation, hierarchy_info, code_rate_HP_stream, code_rate_LP_stream, guard_interval,	[0x40]
network_id, transmission_mode, other_frequency_flag, reserved(5bits)	[0x00]

- currently_available, selected

The function of currently_available is shown in Table 5-19. The same information as that of the no_RF of antenna_input_info (values are reversed between "0" and "1") is set in the currently_available of system_specific_multiplex_selection_attributes. However, when the Tuner Subunit is incapable of normal tuning operation for some reason (e.g., the terrestrial adapter may

not respond to external channel operation for the sake of internal operation), currently_available can be set to "0" to indicate a condition that differs from no_RF.

In the terrestrial adapter, "selected" is always set to "1".

Table 5-19 currently_available

Field	Meaning
Currently_available	Normal tuning operation has been completed (receiving correctly) =1

- center_frequency

This specifies the center frequency of the broadcast being received by the terrestrial adapter.

Table 5-20 center_frequency

Field	Meaning
center_frequency	Center frequency being received (in 10Hz)

(2) Commands

Terrestrial adapters compliant with Profile 1 of the Enhancements Tuner DBV must support the commands described below. They are divided into AV/C General, AV/C Descriptor, and AV/C Tuner commands.

For the detailed information on each command, refer to AV/C General, AV/C Descriptor, and AV/C Tuner.

AV/C General commands

The terrestrial adapter supports the AV/C General commands listed in Table 5-21.

Table 5-21 Mandatory AV/C General commands

Opcode	Value	Command Type	Description	Support
UNIT INFO	0x30	STATUS	-	mandatory (Note 1)
SUBUNIT INFO	0x31	STATUS	-	mandatory
POWER	0xB2	CONTROL/ STATUS	Power control (CONTROL)/ Status (STATUS)	Mandatory (Note 2)

Note 1: The unit_type of UNIT INFO status response shall be Tuner (00101b).

Note 2: Support of the POWER command is mandatory for the Unit and optional for the Tuner Subunit. When the POWER command is supported also for the Tuner Subunit, the same internal operation shall be carried out by the command for both the Unit and the Tuner Subunit and the same condition shall be given after the transition. The POWER ON CONTROL command may not be received by the terrestrial adapter, because its power could be completely turned off depending on the product planning. The CONTROL command is considered to be supported even in such a case, as long as the command is accepted when the power of the terrestrial adapter is on.

AV/C Descriptor commands

The terrestrial adapter supports the AV/C Descriptor commands listed in Table 5-22.

Table 5-22 Mandatory AV/C Descriptor commands

Opcode	Value	Command Type	Description	Support
OPEN DESCRIPTOR	0x08	CONTROL	Obtains an access right of the Descriptor	mandatory (Note 1)
OPEN DESCRIPTOR	0x08	STATUS	Checks the access status of the Descriptor	mandatory
READ DESCRIPTOR	0x09	CONTROL	Loads data from the Descriptor	mandatory

Note 1: For the OPEN DESCRIPTOR command, only read_open subfunction (0x01) and close subfunction (0x00) are supported.

AV/C Tuner command

The terrestrial adapter supports the AV/C Tuner commands listed in Table 5-23.

Table 5-23 Mandatory AV/C Tuner commands

Opcode	Value	Command Type	Description	Support
DIRECT SELECT INFORMATION TYPE (DSIT)	0xC8	CONTROL	Frequency tuning (however, “replace” subfunction is mandatory)	mandatory (Note 1)

Note 1: DIRECT SELECT INFORMATION TYPE command must support “replace” (0xD2) subfunction.

1) DIRECT SELECT INFORMATION TYPE command

DIRECT SELECT INFORMATION TYPE command is defined in the AV/C Tuner.

Structure of the DSIT command is shown in Table 5-24.

Table 5-24 DIRECT SELECT INFORMATION TYPE command

Structure	Number of bits	Value ^(Note 1)
DIRECT SELECT INFORMATION TYPE	8	0xC8
source_plug	8	
subfunction	8	[0xD2]
status	8	0xFF
system_id	8	0x20
input, antenna_number(7bits)	8	0x00
system_specific_search_flags{ orb_pos, main_freq_up, main_freq_down, service_id, reserved(4bits) }	8	[0x00]
system_specific_multiplex_selection_length	8	0x11
system_specific_multiplex_selection{ system_specific_multiplex_attributes_valid_flags{ reserved_field, center_frequency, bandwidth, constellation, hierarchy_info, code_rate_HP_stream, code_rate_LP_stream, guard_interval network_id, reserved(7bits) }	8	[0x40]
	8	[0x00]
system_specific_multiplex_selection_attributes{ currently_available, selected, reserved(6bits) center_frequency bandwidth(3bits), reserved(5bits) constellation(2bits), hierarchy_info(3bits), code_rate_HP_stream(3bits) code_rate_LP_stream(3bits), guard_interval(2bits), transmission_mode(2bits), other_frequency_flag network_id }	8	[0x00]
	32	[0x00000000]
	8	[0x00]
	8	[0x00]
	8	[0x00]
	8	[0x00]
	16	[0x0000]
number_of_dsit_selection_specifications	8	0x00

Note 1: Values are described for fields in which a fixed value is specified and for fields in which a value can be set optionally but a default value is defined (default values are indicated in []). See also the following description of fields.

- source_plug

This field indicates the number of the source plug that outputs the service selected by the Tuner Subunit.

- subfunction

Support of "replace" (subfunction=0xD2) is mandatory, and other subfunctions (clear, remove,

append, new) are optional.

- input

To select input from the antenna destination plug, set the value of this field to "0". To select input from the demux destination plug, set the value to "1". For the terrestrial adapter, which does not have a demux destination plug, set the value to "0".

- antenna_number

Because the value of the input field is fixed to "0", antenna_number indicates the index value of antenna_spec specified by the Tuner Subunit Identifier Descriptor of the connected antenna.

Normally, antenna_number=0x00 because only one antenna_spec is defined.

- system_specific_search_flags

For system_specific_multiplex/service_selection_attributes corresponding to a flag set to "1," search operation starts from a set value.

In the terrestrial adapter, specification of up-search (main_freq_up) and down-search (main_freq_down) by center frequency (center_frequency) can be supported optionally. The values of system_specific_search_flags are 0x40 and 0x20 in up-search and down-search, respectively.

Search operation shall start from the center frequency specified in the center_frequency of system_specific_multiplex_selection_attributes.

- system_specific_multiplex_attributes_valid_flags

Because tuning by center frequency is supported in the terrestrial adapter, the center_frequency of system_specific_multiplex_attributes_valid_flags must be set to "1" (effective).

Table 5-25 system_specific_multiplex_attributes_valid_flags

Field	Value
reserved_field, center_frequency, bandwidth, constellation,	[0x40]

hierarchy_info, code_rate_HP_stream, code_rate_LP_stream, guard_interval	
network_id, reserved(7bits)	[0x00]

- center_frequency

This specifies the center frequency of the broadcast to be received. The center_frequency field has a length of 32 bits, and values therein are expressed by increments of 10 Hz.

2) DIRECT SELECT INFORMATION TYPE command response

- Response code

When returning a response of "NOT IMPLEMENTED", the opcode and operand of the DSIT command received from the controller are added to the response without change. (Note: the DSIT command of the AV/C Tuner is vaguely described.) INTERIM shall not be used as a response when receiving the DSIT command.

If an unsupported parameter is specified by the DSIT command, tuning operation is not performed. If the receiver can determine within 100 msec that the parameter is not supported, it returns a "NOT IMPLEMENTED" response. If the receiver cannot determine within 100 msec, it may return an "ACCEPTED" response regardless of the support state without waiting till the end of tuning operation. However, the receiver should ideally be designed to be able to make the necessary judgement within 100 msec.

When "ACCEPTED" is returned in response to the DSIT command from the controller without waiting till the end of tuning operation, the status field described in the next paragraph should be set to "0x01" and the "searching" of the Tuner Status Descriptor should immediately be set to "1", and then to "0" when the tuning is finished.

Some terrestrial adapters may not be able to perform tuning operation even when "ACCEPTED" is returned in response to the DSIT command because, for example, an invalid parameter has been specified. Thus, to determine with certainty whether the target has completed the assigned operation, the terrestrial-compatible BS/BS broadband CS receiver should check not only the currently_available flag but also center_frequency.

- status

Table 5-26 shows the response of the terrestrial-compatible BS/BS broadband CS receiver upon the

DSIT command and the expected operation of the receiver thereafter.

Table 5-26 DSIT command response

Status of the terrestrial adapter when DSIT command is received	Response code	Status field in the Response frame	Controller operation
Tuning is performed according to the DSIT command	ACCEPTED	0x00	-
Tuning is performed after the receiver determines some parameters	ACCEPTED	0x01	If the tuning status is required to be checked, see the Tuner Status Descriptor. (Note 1)
Returns “ACCEPTED” before completing the tuning	ACCEPTED	0x01	If the tuning status is required to be checked, see the Tuner Status Descriptor. (Note 1)
Tuning impossible	REJECTED	0xFF	-
Not supported	NOT IMPLEMENTED	0xFF	-

Note 1 The terrestrial-compatible BS/BS and broadband CS digital receiver shall check the tuning status of the terrestrial adapter in the following operation procedure.

1. Waits until the Tuner Status descriptor has the status of searching=0.
It repeats checking until the “searching” bit becomes "0".
2. Checks the currently_available field of System_specific_multiplex_selection_attributes.
3. Checks the center frequency of the broadcasting selected in the center_frequency field of System_specific_multiplex_selection_attributes.
4. Checks the value of the signal_strength field of antenna_general_system_info if reception status information is needed.

(3) Tuner model

Connection model of the terrestrial adapter is shown in Fig. 5-3.

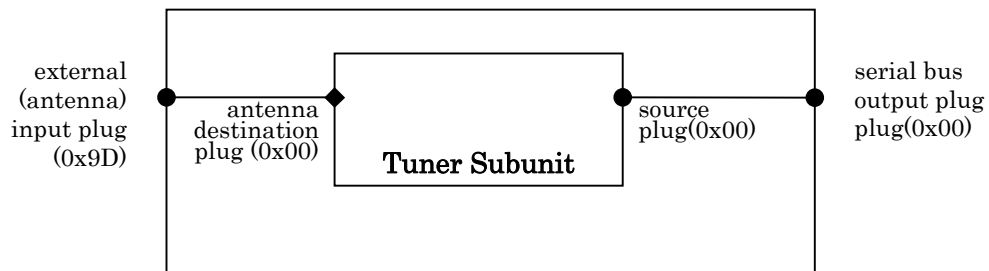

Fig. 5-3 Tuner Subunit connection model (example)

The Tuner subunit shall have an antenna destination plug for input and a source plug for output.

The antenna destination plug and the source plug shall always be connected to the external (antenna) input plug and the serial bus output plug, respectively.

In the terrestrial adapter, use of "0x9D" is recommended for the external (antenna) input plug number.

Because all the connections are fixed, it is recommended that the receiver does not support the CONNECT control command and returns NOT IMPLEMENTED. The CONNECT Status command may be implemented in the receiver.

Appendix 6 Receiving antenna system for broadband CS digital broadcasting and notices regarding the system.

(Appendix 6 is only available in the Japanese version.)

**Appendix 7 Satellite receiving antenna system described in Rec. ITU-R
BO.1213.**

(Appendix 7 is only available in the Japanese version.)

Appendix 8 Desired performance standard of satellite DIRD

(Appendix 8 offers alternative standards that must be performed, if during measurement the satellite repeater of the transmission path equivalent thereto cannot be prepared. Appendix 8 is only available in the Japanese version.)

Appendix 9 Bidirectional communications

1. Line connection modes and functions/protocols necessary for the receiver

In bidirectional communications, the devices to be connected to the receiver, the protocols, and the retained content of the connection information differ, depending on the connection mode between the receiver and the line. Accordingly, an explanation will be given for each type of line that will be used in bidirectional communications and for each connection mode.

1.1 PSTN line

1.1.1 Connection mode

For PSTN lines, there are low-speed modem connections, a high-speed modem connection, and a high-speed modem connection (with TCP/IP), the connection modes for which are shown in Figs. 1.1.1 to 1.1.3.

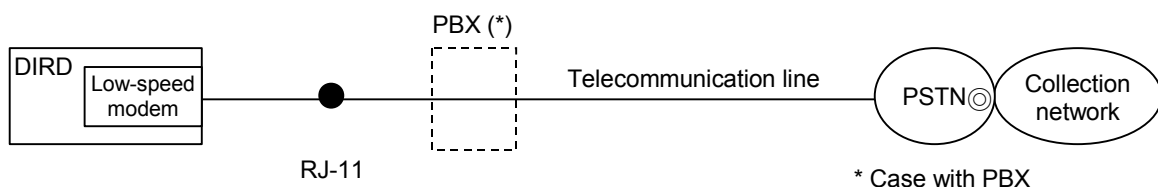

Fig. 9.1.1 Low-speed modem connection

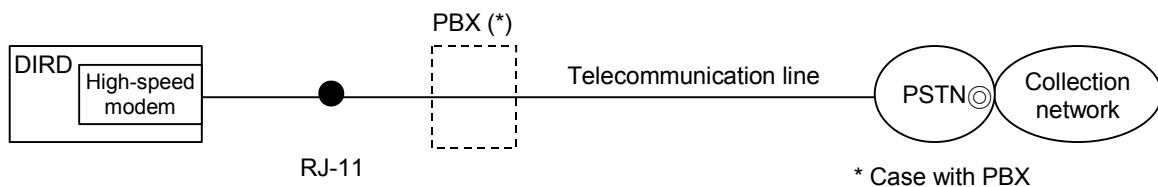

Fig. 9.1.2 High-speed modem connection

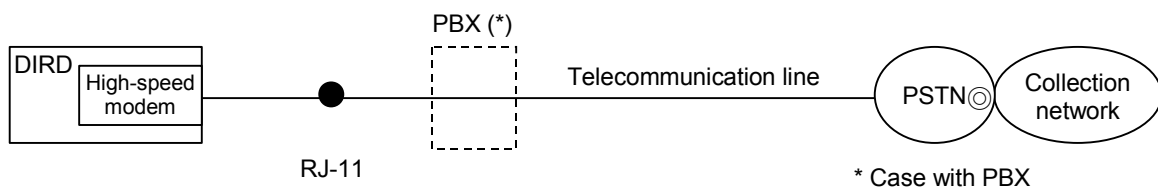

Fig. 9.1.3 High-speed modem connection (with TCP/IP)

1.1.2 Connection modes and necessary receiver functions/protocols

The correspondence between the connection mode with the PSTN line and the necessary receiver functions/protocols are as shown in Table 1.1.1. The protocol that corresponds to an access point to which a connection is to be made must be selected.

Table 9.1.1 Connection mode with a PSTN line and necessary functions/protocol for the receiver

	Location at which ISP connection information is retained	Specifying-destination telephone number from BML	Necessary protocol for DIRD
Low-speed modem connection	–	○	Partially compliant with X.28 Free transmission (TTY procedure), BASIC system procedure, BASIC procedure (JISX5002), HDLC procedure (JISX5104, X5105, X5106), PPP in HDLC-like Framing (RFC1662), HTTP1.0 subset
High-speed modem connection	–	○	Partially compliant with X.28 Free transmission (TTY procedure), BASIC system procedure, BASIC system procedure (JISX5002), HDLC procedure (JISX5104, X5105, X5106), PPP in HDLC-like Framing (RFC1662), HTTP1.0 subset
High-speed modem connection (with TCP/IP)	DIRD	○	PPP IPCP PAP CHAP PPP IPCP Extensions for Name Server Address (RFC1877)

1.2 Portable phone (PDC/PDC-P), PHS, and IMT2000

1.2.1 Connection modes

For portable phone lines, there are PDC-MODEM, PHS-PTE, PHS, PDC, PDC-P, and IMT-2000 connections, the connection modes for which are shown in Figs. 1.2.1 to 1.2.6.

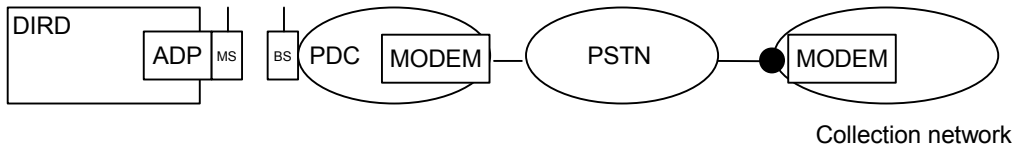

Fig. 9.2.1 PDC-MODEM connection

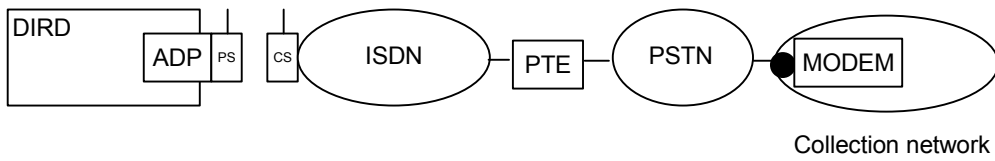

Fig. 9.2.2 PHS-PTE connection

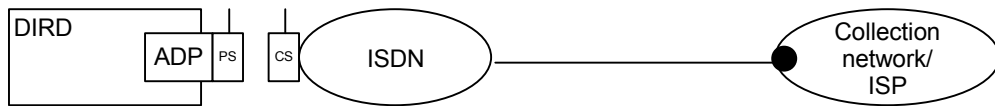

Fig. 9.2.3 PHS connection

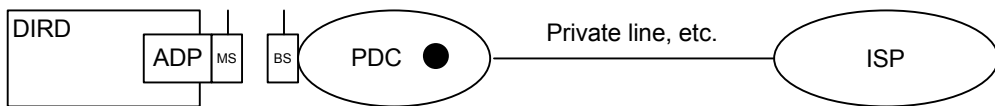

Fig. 9.2.4 PDC connection

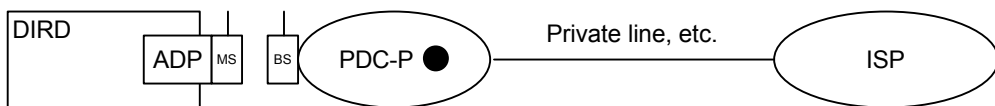

Fig. 9.2.5 PDC-P connection

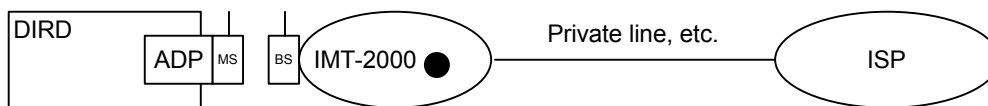

Fig. 9.2.6 IMT-2000 connection

- : Access point, etc.
- BS: Base Station
- CS: Cell Station
- MS: Mobile Station
- PS: Personal Station
- PTE: Protocol Transfer Equipment
- ADP: ADaPter

1.2.2 Connection modes and necessary receiver functions/protocols

The correspondence between the connection mode with a portable telephone line and the necessary receiver functions/protocols is as shown in Table 1.2.1.

Table 9.2.1 Connection mode with a portable telephone line and necessary functions/protocol for the receiver

	Location at which ISP connection information is retained	Specifying-destination telephone number from BML	Necessary protocol for DIRD + ADP
PDC·MODEM connection PHS-PTE connection PHS connection	DIRD	○	Partially compliant with X.28 Free transmission (TTY procedure), BASIC system procedure, BASIC procedure (JISX5002), HDLC procedure (JISX5104, X5105, X5106), PPP in HDLC-like Framing (RFC1662), HTTP1.0 subset
PDC connection PDC-P connection PHS connection	DIRD	○	PPP LCP Extension (RFC1570) IPCP PAP CHAP PPP IPCP Extensions for Name Server Address (RFC1877)

	Location at which ISP connection information is retained	Specifying-destination telephone number from BML	Necessary protocol for DIRD + ADP
	Location at which ISP connection information is retained	Specifying-destination telephone number from BML	Necessary protocol for DIRD + ADP
IMT-2000 connection	DIRD	○	PPP LCP Extension(RFC1570) IPCP(RFC1332) PAP(RFC1334) CHAP PPP IPCP Extensions for Name Server Address (RFC1877)

1.3 ISDN line

1.3.1 Connection modes

For ISDN lines, there are R-point, S/T-point, dial-up router, and TA analog port connections, the connection modes for which are shown in Figs. 1.3.1 to 1.3.4.

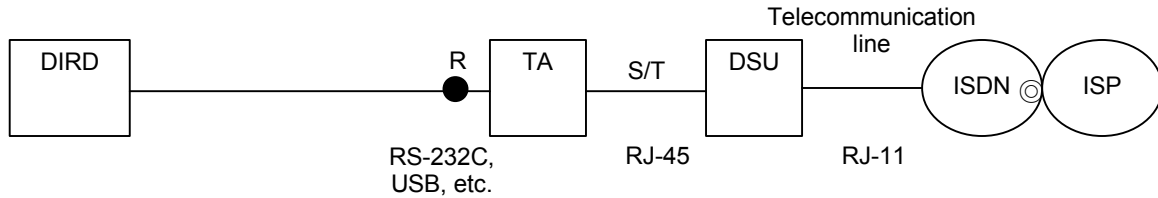

Fig. 9.3.1 R-point connection

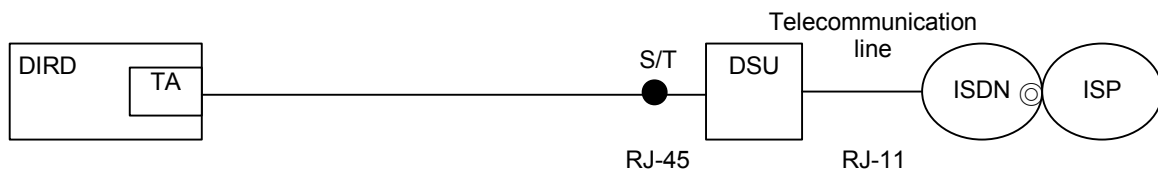

Fig. 9.3.2 S/T-point connection

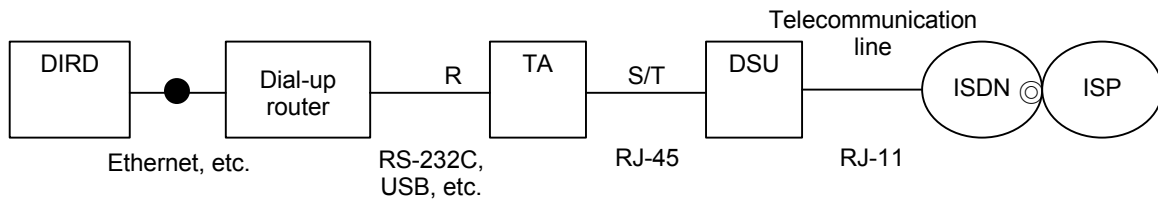

Fig. 9.3.3 Dial-up router connection

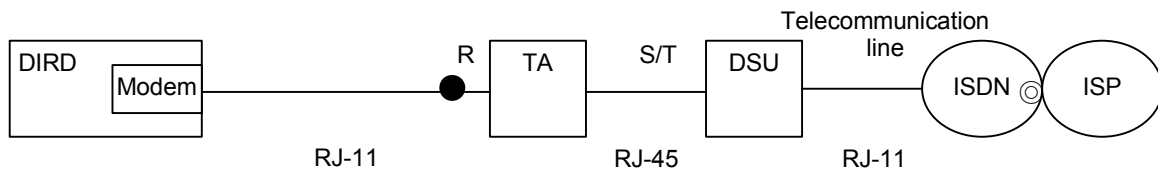

Fig. 9.3.4 TA analog port connection

1.3.2 Connection modes and necessary receiver functions/protocols

The correspondence between the connection mode with the ISDN line and the necessary receiver functions/protocols is as shown in Table 1.3.1.

Table 9.3.1 Connection mode with the ISDN line and necessary functions/protocol for the receiver

	Location at which the ISP connection information is retained	Specifying-destination telephone number from BML	Compatibility with the always-on connection ISDN	Compatibility with D-ch packet (*)	Location at which the always-on connection AP number is retained	IP acquisition-related protocol necessary for DIRD	Call-control protocol necessary for DIRD
R-point connection	DIRD	○	○	○	DIRD	PPP IPCP PAP CHAP PPP IPCP Extensions for Name Server Address (RFC1877)	X.25 packet level (*)
S/T-point connection	DIRD	○	○	○	DIRD	PPP IPCP PAP CHAP PPP IPCP Extensions for Name Server Address (RFC1877)	I.430, Q.921, Q.931, X25 packet level (*)
Dial-up router connection	Dial-up router	×	○	×	Dial-up router	IEEE802.2 IEEE802.3, IEEE802.11 ARP DHCP	
TA analog port connection	DIRD	○	×	×	–	PPP IPCP PAP CHAP PPP IPCP Extensions for Name Server Address (RFC1877)	

1.4 ADSL line

1.4.1 Connection modes

For ADSL lines, there are ADSL **modem** connection (shared with the telephone line), an ADSL **modem** connection (not shared with the telephone line), router connection, and analog port connection, the connection modes for which are shown in Figs. 1.4.1 to 1.4.4.

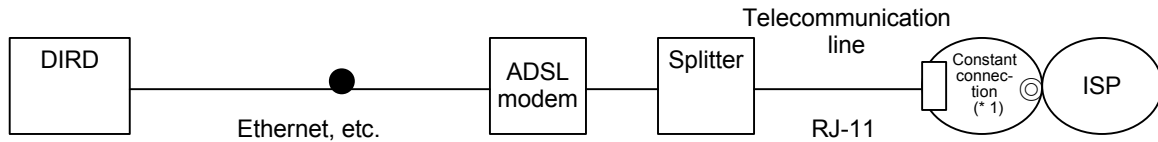

Fig. 9.4.1 ADSL modem connection (shared with the telephone line)

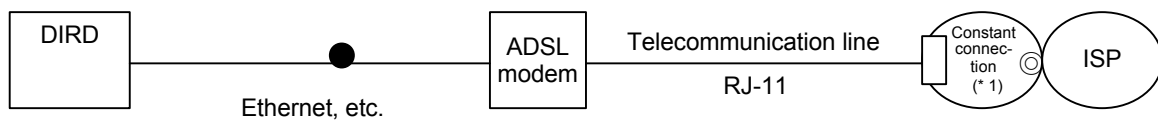

Fig. 9.4.2 ADSL modem connection (not shared with the telephone line)

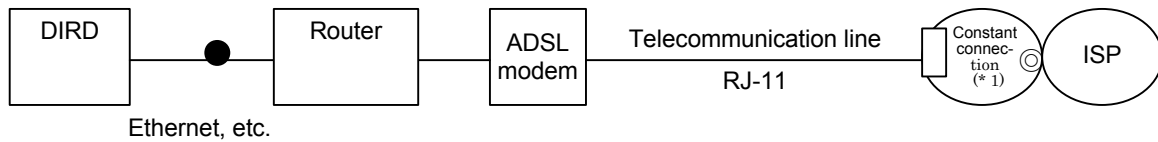

Fig. 9.4.3 Router connection

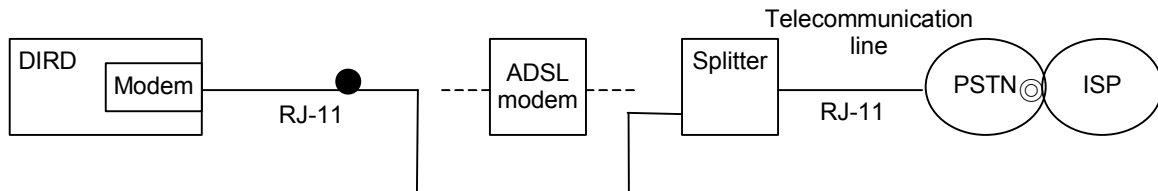

Fig. 9.4.4 Analog port connection (shared with the telephone line)

(* 1) There is a format of constant connection by ISP direct connection, not using the “constant connection service”.

1.4.2 Connection modes and necessary receiver functions/protocols

The correspondence between the connection mode with the ADSL line and the necessary receiver functions/protocols is as shown in Table 1.4.1.

Table 9.4.1 Connection mode with the ADSL line and necessary functions/protocol for the receiver

	Location at which ISP connection information is retained	Specifying destination telephone number from BML	ADSL compatibility	IP acquisition-related protocol necessary for DIRD
ADSL modem connection (shared)	DIRD	×	○	IEEE802.2 IEEE802.3 ARP PPP PPPoE IPCP PAP CHAP PPP IPCP Extensions for Name Server Address (RFC1877) DHCP (* 1)
ADSL modem connection (not shared)	DIRD	×	○	IEEE802.2 IEEE802.3 ARP PPP PPPoE IPCP PAP CHAP PPP IPCP Extensions for Name Server Address (RFC1877) DHCP (* 1)
Router connection	Router	×	○	IEEE802.2 IEEE802.3, IEEE802.11 ARP DHCP
Analog port connection	DIRD	○	×	PPP IPCP PAP(RFC1334) CHAP(RFC1994) PPP IPCP Extensions for Name Server Address (RFC1877)

(* 1) In the case of using DHCP, PPP/PPPoE/IPCP/PAP/CHAP/PPP/PPP/PPP Extensions for Name Server Address (RFC1877) is not used.

1.5 FTTH line

1.5.1 Connection modes

For FTTH lines, there are ONU and router connections, the connection modes for which are shown in Figs. 1.5.1 and 1.5.2.

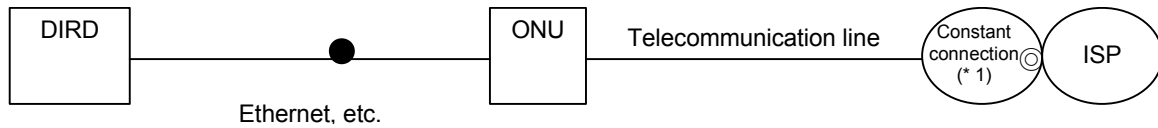

Fig. 9.5.1 ONU connection

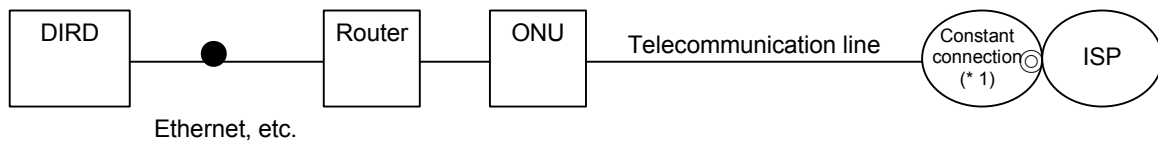

Fig. 9.5.2 Router connection

(*1) There is a format of constant connection by ISP direct connection, not using the “constant connection service”.

1.5.2 Connection modes and necessary receiver functions/protocols

The correspondence between the connection mode with the FTTH line and the necessary functions/protocol for the receiver is as shown in Table 1.5.1.

Table 9.5.1 Connection mode with the FTTH line and necessary functions/protocol for the receiver

	Location at which ISP connection information is retained	Specifying destination telephone number from BML	Compatibility with optical IP connection	IP acquisition-related protocol necessary for DIRD
ONU connection	DIRD	×	○	IEEE802.2 IEEE802.3 ARP PPP PPPoE IPCP PAP CHAP PPP IPCP Extensions for Name Server Address (RFC1877) DHCP (* 1)
Router connection	Router	×	○	IEEE802.2 IEEE802.3, IEEE802.11 ARP DHCP

(*1) In the case of using DHCP, PPP/PPPoE/IPCP/PAP/CHAP/PPPIPCP Extensions for Name Server Address (RFC1877) is not used.

1.6 CATV line

1.6.1 Connection modes

For CATV lines, there are cable modem and router connections, the connection modes for which are as shown in Figs. 1.6.1 and 1.6.2.

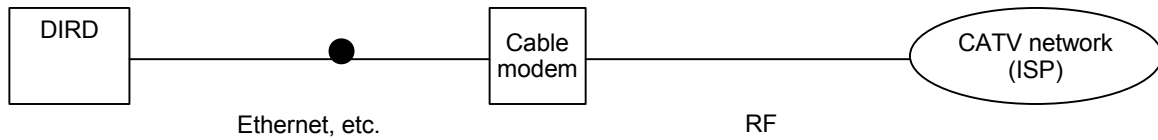

Fig. 9.6.1 Cable modem connection

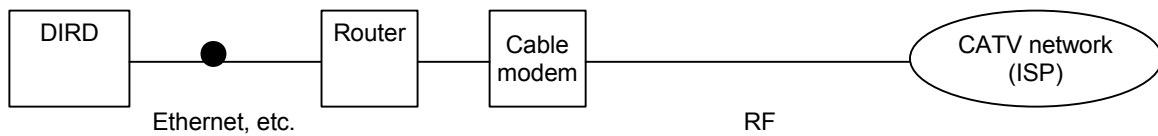

Fig. 9.6.2 Router connection

1.6.2 Connection modes and necessary receiver functions/protocols

The correspondence between the connection mode and the necessary receiver functions/protocols of the CATV line is as shown in Table 1.6.1.

Table 9.6.1 Connection mode with the CATV line and necessary functions/protocol for the receiver

	Location at which ISP connection information is retained	Specifying connection destination telephone number from BML	IP acquisition-related protocol necessary for DIRD
Cable modem connection	DIRD	×	IEEE802.2 IEEE802.3 ARP DHCP PAP CHAP PPP IPCP Extensions for Name Server Address(RFC1877)
Router connection	Router	×	IEEE802.2 IEEE802.3, IEEE802.11 ARP DHCP

2. Supplementing of the values of information elements for bidirectional connection

The values are stipulated for the information elements specified in 11.5.7.1 Viewer-set information, 11.5.7.2 Communications-related information, and 11.5.7.3 Security communications-related information in Chapter 11: Specifications of bidirectional communications functions. The computational grounds for the values and supplementary explanations will be given below.

2.1 Viewer-set information

2.1.1 Common information

- 1) ZIP code Indicates the ZIP code. Note that it must not include a hyphen.
- 2) Priority-use line type Indicates a line type that was prioritized when multiple line types are provided. It must provide for future increases in the number of line types.
- 3) Common-carrier identification The longest current common-carrier identification number is seven digits (002YZN1N2). This is the number to be prefixed to the required telephone number by the receiver function.
- 4) Fixed-priority connection cancellation number In cases in which a telephone line connected between a certain common carrier and the receiver is set in fixed-priority connection mode, this is the number (“122”) to be prefixed to the required telephone number by the receiver function when a common carrier other than said common carrier is used.
- 5) Sender-number notification number In cases in which the sender has registered the sender’s number with the common carrier as either one that is always notified (ALWAYS-NOTIFY) or one that is never notified (ALWAYS-NOT-NOTIFY), if this value is set to indicate “not added,” the registered state becomes effective. When the sender wishes to cancel a notification to the common carrier on a line that has previously been set as ALWAYS-NOTIFY, the number “184” must be prefixed to the required number by the receiver function for each call. Moreover, when the sender wishes to make a notification to the common carrier on a line that has previously been set as ALWAYS-NOT-NOTIFY, the number “186” must be prefixed to the required number for each call by the receiver function.
- 6) Outside-line acquisition number A number to be prefixed to the required number to acquire an outside line when the receiver is connected with PBX. This number must conform to the specifications of the PBX to which the receiver is connected. It is generally a one-digit number, but may contain multiple digits, depending on the setting of the PBX; therefore, a size as large as approximately four digits was assumed.
- 7) Dial type..... Indicates the dial type of the telephone line. There are three dialtypes, tone, pulse (10 PPS) and pulse (20 PPS).

2.1.2 TCP/IP-related information

2.1.2.1 ISP connection information

- 1) ISP name Name or abbreviation of the ISP. Note that there are cases in which access point information and the like are included in the ISP name (e.g., ISP (Tokyo No. 1)). For this value, a size capable of accommodating *kana* characters was assumed.
- 2) AP telephone number This number must conform to the telecommunication number rule of Ordinance No. 82 of the Ministry of Posts and Telecommunications. For this value, a size of up to 30 digits was assumed, as the maximum length of a character string that can be specified as an argument of the connection function connect(), in accordance with the BASIC system protocol, was 30 digits.
- 3) User ID..... Note that this value depends on the ISP service type. Note that a user ID including the domain name is also treated as the user ID (e.g., abcd@arib.or.jp). As the character string of the user ID in the always-on connection service must be 63 bytes or less, a character string of up to 64 digits was assumed.
- 4) Password..... Note that password length depends on the ISP service style. This value was set to a maximum of 32 characters, based on the assumption that this length would be necessary to ensure security.
- 5) DNS-server IP address
(primary) The storage area in which the IP-address space (32 bits) stipulated by RFC791 (IPv4) can be written must be taken into consideration.
- 6) DNS-server IP address
(secondary) The storage area in which the IP-address space (32 bits) stipulated by RFC791 (IPv4) can be written must be taken into consideration.
- 7) No-communication cutoff
timer value The state in which no packet transmission/reception is performed for a certain period of time is referred to as the

“no-communication” state. Upon expiration of a prescribed duration thereof, PPP cutting or line-dropping is conducted as a receiver function. The no-communication cutting timer value indicates the maximum duration of the no-communication state. It was decided that the value would be an operational stipulation to ensure that the service hours of the broadcast service carrier and the opinions of viewers and the like are reflected therein.

2.1.2.2 Fixed IP connection information

- 1) IP address The storage area in which the IP-address space (32 bits) stipulated by RFC791 (IPv4) can be written must be taken into consideration.
- 2) Subnet mask..... The storage area in which the subnet address (32 bits) stipulated by RFC950 (subnet) can be written must be taken into consideration.
- 3) Default gateway address The storage area in which the IP-address space (32 bits) stipulated by RFC791 (IPv4) can be written must be taken into consideration.

2.1.2.3 Connection mode information

- 1) IP address gain designation When the Ethernet is connected, it indicates the protocol, etc. used for gaining the IP address.

2.1.2.4 TCP/IP application setting information

- 1) SMTP server name/address
.....(FQDN representation)

The size limit of the domain name of DNS stipulated by RFC1034/RFC1035 (DNS) must be taken into consideration. For this value, a length that also allows the application of a Japanese domain was assumed.

.....(IP address representation)

The storage area in which the IP-address space (32 bits) stipulated by RFC791 (IPv4) can be written must be taken into consideration.
- 2) POP server name/address
.....(FQDN representation)

The length limit of a domain name stipulated by RFC1034/RFC1035 (DNS) must be taken into consideration. For this value, a length that also allows the application of a Japanese domain and the like was assumed.

.....(IP-address representation)

The storage area in which the IP-address space (32 bits) stipulated by RFC791 (IPv4) can be written must be taken into consideration.

- 3) Mail address The mail address must take the form of “user_name@domain_name.” For this value, the maximum length of the user name and of the domain name stipulated by RFC821 (SMTP) were taken into consideration.

- 4) Password..... Password to be used to authenticate the user for a mailing service provided by the ISP. Note that this value depends on the service type of the mail service provider.

- 5) HTTP Proxy server name/address
.....(FQDN representation)

The maximum length of the DNS domain name stipulated by RFC1034/RFC1035 (DNS) must be taken into consideration. For this value, a length that also allows the application of a Japanese domain or the like was assumed.

.....(Internet Protocol address representation)

The storage area in which the IP address space (32 bits) stipulated by RFC791 (IPv4) can be written must be taken into consideration.

- 6) HTTP Proxy-server port number The storage area in which a port number of 16 bits stipulated by RFC793 (TCP) can be stored must be taken into consideration.

- 7) FTP Proxy-server name/address
.....(FQDN representation)

The maximum length of the DNS stipulated by RFC1034/RFC1035 (DNS) must be taken into consideration. For this value, a length that also allows the application of a Japanese domain or the like was assumed.

.....(IP-address representation)

The storage area in which the IP-address space (32 bits) stipulated by RFC791 (IPv4) can be written must be taken into consideration.

- 8) FTP Proxy-server port number The area in which a port number of 16 bits stipulated by

RFC793 (TCP) can be stored must be taken into consideration.

2.2 Communications-related information

- 1) Line type..... Basically, the same type of line as the priority-use line type is set. However, there may be cases in which multiple settings are made. Future extendibility must be taken into consideration.
- 2) Physical layer protocol..... There may be cases in which multiple information elements are set. Future extendibility must be taken into consideration.
- 3) Data link and transfer protocol There may be cases in which multiple information elements are set. Future extendibility must be taken into consideration.
- 4) Security class..... There may be cases in which multiple information elements are set. Future extendibility must be taken into consideration.

2.3 Security-related information

- 1) Implemented security Multiple implemented algorithm sets (28 types) are described by TLS 1.0, and there may be cases in which multiple algorithm sets are specified. Future extendibility must be taken into consideration.
- 2) Route CA certificate As a result of the certificate issued by CA used by the receiver, the quantity of data varies depending on the number of nodes of the route. Determination of the maximum number of nodes enables the data length to be fixed. It was decided that the value of the storage area would be an operational stipulation.

Appendix 10 Performance of the receiver for digital terrestrial television broadcasting

1. Characteristics of the tuner unit

1.1 The range of receiving frequency

The tuner unit for the receiver must be capable of receiving the frequency bands allocated for digital terrestrial television broadcasting.

Table 10-1 Center frequency (UHF band)

Transmission channel	Center frequency
UHF ch 13	473 + 1/7 MHz
UHF ch 14	479 + 1/7 MHz
UHF ch 15	485 + 1/7 MHz
:	:
:	:
UHF ch 61	761 + 1/7 MHz
UHF ch 62	767 + 1/7 MHz

For terrestrial analog broadcasting, the proportion of households served by community reception (for multiple-unit structures) is currently nearly half of all households, and this proportion is projected to continue increasing. Since usable bands for many of these cable facilities do not cover up to the UHF band, UHF channels are down-converted to empty channels in the VHF, MID and SHB. Then the range of receiving frequency is expected to cover the frequency bands shown in Table 10-2, 10-3 and 10-4 for the receivers, particularly stationary receivers, that may use for community reception.

Because the details of the usage of the VHF band after the termination of analog broadcasting on July 25, 2011 have not been determined yet, possible interference of radio wave used for broadcasting services (excluding television broadcasting) and mobile services (for telecommunications, public use, and general business use) in the VHF band is concerned in re-transmission involving frequency conversion into the VHF band. Consideration should be given to this interference.

Table 10-2 Center frequency (VHF band)

Receiving channel	Center frequency
VHF ch 1	93 + 1/7 MHz
VHF ch 2	99 + 1/7 MHz
VHF ch 3	105 + 1/7 MHz
VHF ch 4	173 + 1/7 MHz
VHF ch 5	179 + 1/7 MHz

VHF ch 6	185 + 1/7 MHz
VHF ch 7	191 + 1/7 MHz ^(Note 1)
VHF ch 8	195 + 1/7 MHz ^(Note 1)
VHF ch 9	201 + 1/7 MHz
VHF ch 10	207 + 1/7 MHz
VHF ch 11	213 + 1/7 MHz
VHF ch 12	219 + 1/7 MHz

Note 1: There is frequency duplication(2 MHz) between VHF ch 7 and ch 8.

Table 10-3 Center frequency (MID band)

Received channel	Center frequency
Ch C13	111 + 1/7 MHz
Ch C14	117 + 1/7 MHz
Ch C15	123 + 1/7 MHz
Ch C16	129 + 1/7 MHz
Ch C17	135 + 1/7 MHz
Ch C18	141 + 1/7 MHz
Ch C19	147 + 1/7 MHz
Ch C20	153 + 1/7 MHz
Ch C21	159 + 1/7 MHz ^(Note 1)
Ch C22	167 + 1/7 MHz ^(Note 1)

Note 1: There is frequency discontinuity(2 MHz) between ch C21 and C22.

Table 10-4 Center frequency (SHB band)

Received channel	Center frequency
Ch C23	225 + 1/7 MHz
Ch C24	231 + 1/7 MHz
Ch C25	237 + 1/7 MHz
:	:
:	:
Ch C63	465 + 1/7 MHz

1.2 Measurement methods

Measurements of the input level and the protection ratio must be conducted using the respective measuring systems specified below.

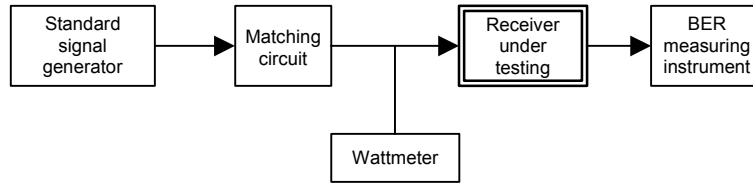

Fig. 1-1 Measuring system for the input level

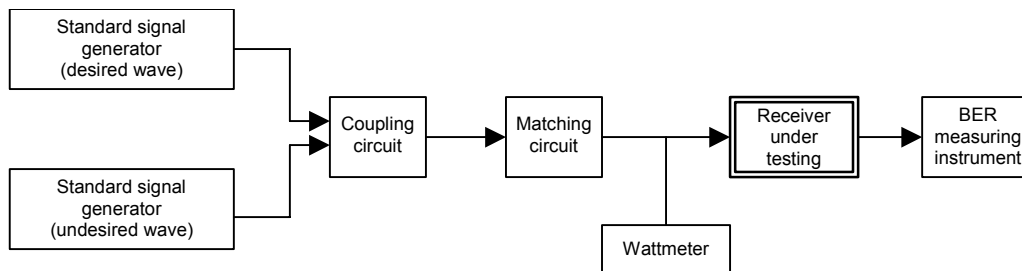

Fig. 1-2 Measuring system for the interference suppression ratio

- For a digital signal source, a standard signal generator with a C/N ratio of 40 dB or more must be used.
- For measurements of protection ratio, the input level of the desired wave (digital) must be sufficiently high to secure a C/N ratio of 35 dB or more for co-channel interference. For adjacent-channel interference, the input level of the desired wave (digital) to the receiver must be -65 dBm.
- A color-bar test pattern for the video signal and monaural audio of 1 kHz with 100% modulation for the audio signal must be used for the analog signal.
- The out-of-band level of the signal source (i.e., a level outside a channel bandwidth of 6-MHz) must be -60 dB or less. The out-of-band level of the analog NTSC signal must be -70 dB or less compared to the peak level of video signal, in order to avoid co-channel interference in the measurement for adjacent-channel interference.
- For power measurements of digital signals, the root-mean-square of the signal level in an OFDM signal bandwidth of 5.7 MHz must be measured; for analog signals, the over peak level for the video signal must be measured.
- The transmission parameters of OFDM must consist of a single hierarchical mode of 64QAM and an inner code rate of 7/8.
- The representative values for the mode, guard interval ratio, and time interleaving must be Mode 3, 1/8, and no time interleaving, respectively. All possible combination of transmission parameters must meet the specifications.
- The BER (bit error rate) must be equal to 2×10^{-4} after the inner-code correction and before RS correction.

1.3 Minimum input level

In fiscal 1999, the Technical Committee on Establishment of Terrestrial Broadcasting Station of the Telecommunications Technology Council submitted a report specifying a required CN ratio of 22 dB when 64 QAM and a convolution code rate of 7/8 are used as transmission parameters (i.e., a CN ratio such that the bit error rate after the inner-code correction becomes 2×10^{-4}). With the measuring system shown in Fig. 1-1, the minimum input level is described as follows, as the external noise is negligible.

Using symbols:

- k: Boltzmann's constant ($= 1.38 \times 10^{-23}$)
- T: Measured temperature ($= 300$ K)
- B: Noise bandwidth ($= 5.7$ MHz)
- NF: Receiver Noise Figure (dB)
- D_{CN}: Receiver equipment deterioration (dB)

We obtain:

$$\begin{aligned} \text{Minimum Input level (dBm)} \\ &= \text{CN (dB)} + 10 \log (kTB) + \text{NF (dB)} + \text{D}_{\text{CN}} \text{ (dB)} \\ &= 22 - 136.271 + 30 \text{ (dBW} \rightarrow \text{dBm Conversion)} + \text{NF (dB)} + \text{D}_{\text{CN}} \text{ (dB)} \\ &= -84.271 + \text{NF (dB)} + \text{D}_{\text{CN}} \text{ (dB)} \end{aligned}$$

Here, assuming that the receiver NF and the receiver equipment deterioration total 9.3 dB, the minimum input level becomes -75 dBm. However, it was considered possible that the minimum input level of -75 dBm was too strict a value based on compatibility with the cross-modulation characteristic required by the stipulation of the adjacent-channel interference suppression ratio, and beyond reasonable achievable levels for a consumer product at this time. Therefore, it is rated as a desired value, which may need to use "low-noise booster" in order to enable reception at an electric-field strength of 60 dB μ V/m in the entire service area. It is expected that a receiver that satisfies the desired value will become commercially practical no later than the time at which digital terrestrial television broadcasting begins.

For reference purposes, the results of simulations of the required CN ratio are shown below for all possible combinations of the modulation scheme and the coding factor of the convolution code stipulated for digital terrestrial broadcasting.

Table 10-5 Required CN ratio

Modulation scheme	Coding rate of the convolution code				
	1/2	2/3	3/4	5/6	7/8
DQPSK	6.2 dB	7.7 dB	8.7 dB	9.6 dB	10.4 dB
QPSK	4.9 dB	6.6 dB	7.5 dB	8.5 dB	9.1 dB
16QAM	11.5 dB	13.5 dB	14.6 dB	15.6 dB	16.2 dB
64QAM	16.5 dB	18.7 dB	20.1 dB	21.3 dB	22.0 dB

Regarding outside the direct reception band (VHF, MID, and SHB), the Regulations for Enforcement of the Cable Television Broadcast Law specifies that carrier levels at the receiver terminal (protector) are to be in the range of 47 to 81 dB μ V. The minimum input level thus becomes -67 dBm in consideration of loss in the customer premises wiring (about 5 dB). For the other technical criteria, reference should be made to Article 26 of the Regulations for Enforcement of the Cable Television Broadcast Law, which is summarized as reference material in the JCTEA STD-011 standard issued by Japan Cable Television Engineering Association.

1.4 Protection ratios

The results of an interference experiment, which are described in Reference 2 of the Digital Broadcasting System Committee Report of these Telecommunications Technology Council for fiscal 1999, are shown in the table below.

Table 10-6 Protection ratios of a 13-segment receiver
(results of interference experiment)

Undesired wave	Item	Protection ratio
Analog television	Co-channel	25 dB or less
	Lower adjacent channel (undesired wave on the lower side)	-33 dB or less (with spurious : -21 dB)
	Upper adjacent channel (undesired wave on the upper side)	-35 dB or less (with spurious : -24 dB)
Digital television	Co-channel	23 dB or less
	Lower adjacent channel (undesired wave on the lower side)	-26 dB or less
	Upper adjacent channel (undesired wave on the upper side)	-29 dB or less

Note that in the case “with spurious,” the interference DU ratio when a spurious of -60 dB level compared to the peak level of the analog video carrier is generated to interfere the digital signal in the adjacent channel is shown.

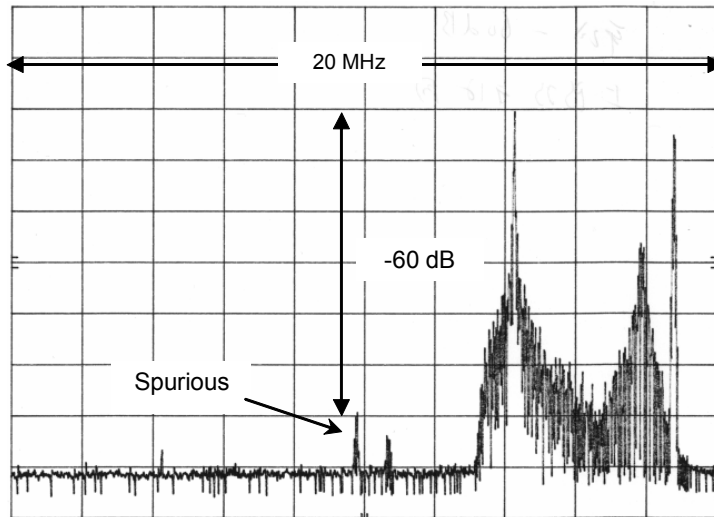

Fig. 1-3 Example of a signal spectrum of an analog television wave with spurious interference

The protection ratio described in the report of the Technical Committee on Establishment of Terrestrial Broadcasting Station of the Telecommunications Technology Council in fiscal 1999 was based on the interference DU ratios given in Table 10-6. However, since practical frequency planning was conducted with the co-channel interference from the analog broadcast wave to the digital broadcast wave relaxed by 10 dB considering on the rigorous frequency congestions, the interference suppression ratio of the receiver in this standard must also be standardized in accordance with the practical conditions of frequency planning.

Table 10-7 Protection ratios of the 13-segment receiver

Un-desired wave	Item	DU ratio by interference experiment	Report of the Telecommunications Technology Council	Practical conditions of frequency planning	Protection ratio
Analog television	Co-channel	25 dB	30 dB	20 dB	18 dB
	Lower adjacent channel (undesired wave on the lower side)	-33 dB (If spurious: -21 dB)	-21 dB	-21 dB	-33 dB
	Upper adjacent channel (undesired wave on the upper side)	-35 dB (If spurious: -24 dB)	-24 dB	-24 dB	-35 dB
Digital television	Co-channel	23 dB	28 dB	28 dB	24 dB
	Lower adjacent channel (undesired wave on the lower side)	-26 dB	-26 dB	-26 dB	-26 dB
	Upper adjacent channel (undesired wave on the upper side)	-29 dB	-29 dB	-29 dB	-29 dB

(1) Co-channel interference from analog television

For co-channel interference from analog television signal, the reported interference protection ratio of 30 dB was based on a DU ratio of 25 dB, the result of the interference experiment, with the addition of a margin that allows for poor reception environments in fringe areas. We are currently conducting a review of concrete frequency planning based the interference protection ratio relaxed to as low as 20 dB, as an improvement of approximately 10 dB can be realized in the simulation by improving the error correction technique in the receiver or the like. Assuming that the receiver can perform normal reception in a concrete frequency planning environment with the co-channel protection ratio of 20 dB, it has been determined that suppression ratio for co-channel interference from analog television signal will be 18 dB.

(2) Co-channel interference from digital broadcasting

The results of an interference experiment have shown that interference from digital broadcasting signal as low as 23 dB was achieved. The protection ratio for frequency

planning was stipulated as 28 dB, allowing for degradation of 5 dB, permitting normal reception even in fringe areas. In this appendix, although the value obtained in the interference experiment should be adopted as a standard, it has been determined that suppression ratio for co-channel interference from digital broadcasting is 24 dB, allowing for a margin in actual instrumentation.

2. Specifications of DIRD

For the specifications of DIRD, potential problems in frequency planning are described below.

Current frequency planning is based on a case in which an SFN (single-frequency network) is used for the effective utilization of frequencies. However, in the case of an SFN, radio interference may occur, depending on the distance between transmitters and the length of the guard interval. As a simulation is conducted in frequency planning based on the assumption that an FFT window is set at a proper location in order to minimize the area under the influence of radio-interference caused by SFN, it is mandatory that the FFT window also be set in accordance with the reception environment of the consumer's receiver.

Appendix 11 Signal processing for different types of server-type broadcast services

Three types of content provision in server-type broadcasting are assumed in Chapter 2 of ARIB STD-B38:

- (1) Contents are viewed only at the time they are received;
- (2) Contents are viewed at the time they are received and also viewed or reproduced after they are accumulated.
- (3) Contents cannot be viewed at the time they are received but can only be viewed or reproduced after they are accumulated.

The flow of signal processing in each of the above cases (1) through (3) are presented in Attached Figs. 1 through 3, respectively.

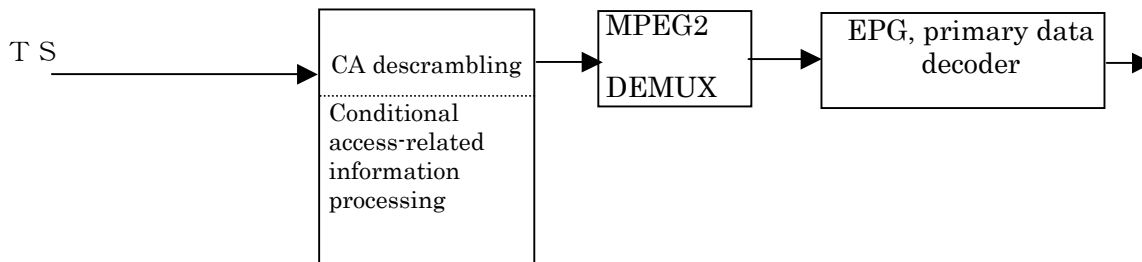

Fig. 11-1 Flow of signal processing in service type (1)

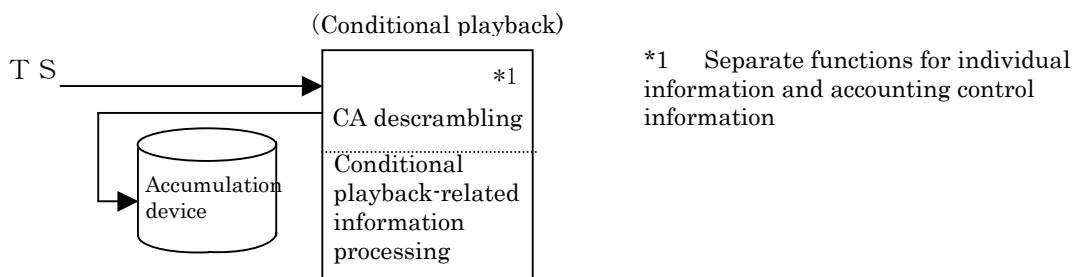

Fig. 11-2-1 Flow of signal processing in service type (2)
(during data accumulation)

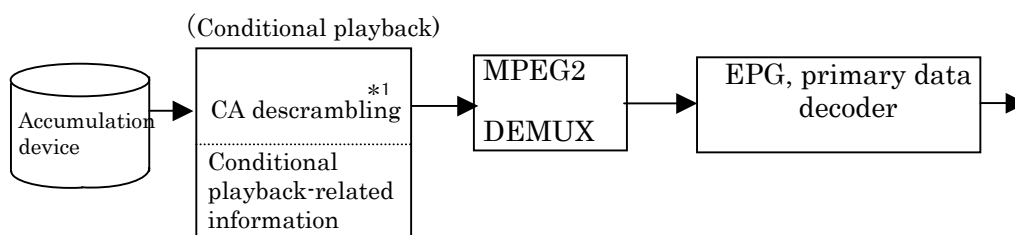

Fig. 11-2-2 Flow of signal processing in service type (2)

(during playback of accumulated data)

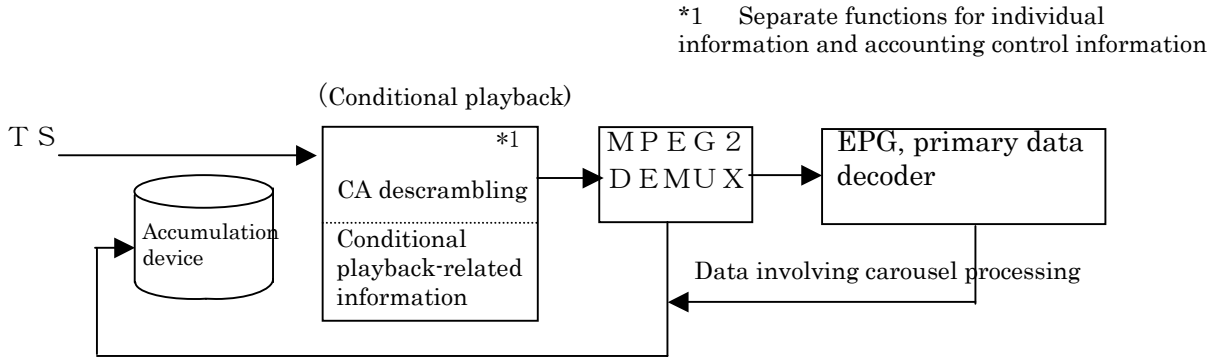

Fig. 11-3-1 Flow of signal processing in service type (3)
(during data accumulation)

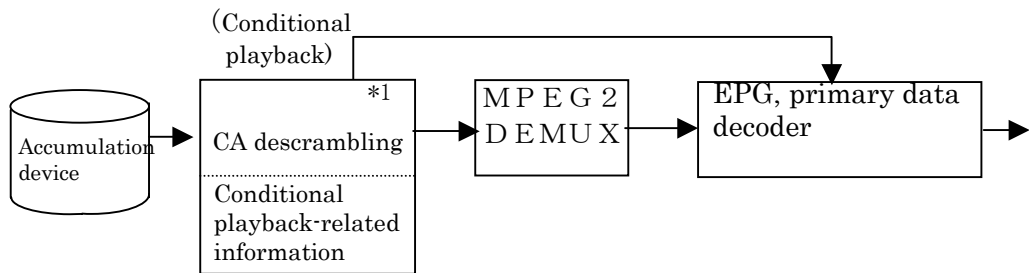

Fig. 11-3-2 Flow of signal processing in service type (3)
(during playback of accumulated data)

Annexes

Annex 1

Fiscal 2001

Report of the Telecommunications Council

Consultation No. 2003

Excerpts from the "Technical Conditions on Rights Protection Schemes Compatible with BS Digital Broadcast Receivers Etc." in the "Technical Conditions on Digital Broadcasting Systems Using Large-Volume Accumulating Functions"

March 13, 2002

Annex 2

Fiscal 2002

Report of the Telecommunications Council

Consultation No. 2003

Excerpts from the "Technical Conditions on Digital Broadcasting Systems Using Large-Volume Accumulating Functions"

September 30, 2002

Annex 1

This Annex contains excerpts from the following report published on March 13, 2002. Refer to the original report as necessary.

Fiscal 2001

Report of the Telecommunications Council

Consultation No. 2003

"Technical Conditions on Rights Protection Schemes Compatible with BS Digital Broadcast Receivers and the like." in the "Technical Conditions on Digital Broadcasting Systems Using Large-Volume Accumulating Functions"

March 13, 2002

6 Technical conditions on rights protection schemes

6.1 Scope of discussion in this interim report

It is an urgent matter to introduce rights protection schemes that can also be used in BS digital broadcasting. Among digital broadcasting systems using large-volume accumulating functions, narrow-band CS digital broadcasting and BS digital broadcasting have already been started and they allow easy connection of external devices that can accumulate contents as digital signals. Thus, technical conditions on rights protection schemes compatible with receivers used for narrow-band CS digital broadcasting and BS digital broadcasting (referred to as “BS digital broadcast receivers”) are discussed here.

The rights protection scheme described in this interim report can also be used in broadband CS digital broadcasting, which was started in March this year, as well as digital terrestrial television broadcasting, digital terrestrial audio broadcasting, and digital satellite audio broadcasting using 2.6-GHz band, which are yet to be started.

6.2 Terminology

The definitions of terms used in Section 6 of IV are listed in Table 6-1.

Table 6-1 Definitions of terms

Term	Description
CA module	The conditional access module, which is used for judging whether broadcast data can be demodulated by the receiver.
DTCP	Digital Transmission Content Protection, which is a rights protection scheme for exchanging contents between devices using IEEE1394. According to a statement, there will be no discriminatory treatment in the use of DTCP. All the BS digital broadcast receivers and D-VHS and hard disk recorders having IEEE1394 interfaces are already DTCP compatible.
IEEE1394	A serial bus interface standardized by IEEE Std 1394-1995 "IEEE Standard for a High Performance Serial Bus". It is suited for high-speed, real-time transfer of data.

Analog output interface	A generic name for output interfaces where signals related to output contents are converted into analog signals in the receiver.
Interface	A generic name for terminals where signals related to contents can easily be extracted by receiver users.
Enforcement	A generic name for means to ensure compliance with the conditions given by rights protection information.
Related information	Information needed to demodulate scrambled contents (descramble key, etc.).
Common information	Related information that is common to all receivers (such as a key common to all receivers).

Individual information	Related information that is specific to individual receivers (such as contract information and receiver-specific keys).
Contents	A collection of images, music, characters, and other data to be played back and viewed by the audience.
Externally connected devices	A generic name for devices connected to receivers through an interface for content accumulation, replaying, viewing, and receiver enhancement.
Conditional access	A system in which charged broadcasts can be received only by using receivers set by the subscribers. This is done by a combination of scrambling and transmission of related information.
Right holder	A person who has the right to permit the use of contents, such as content accumulation, transmission, and editing.
Rights protection information	A generic name for information related to the permission given by right holders on the use of contents. Such information includes (1) conditions of use, (2) information on right holders, and (3) information on the permission of reproduction.
Output interface	A generic name for interfaces used to deliver content-related signals from receivers to externally connected devices.
Scrambling	Electric disordering (encryption) of signal waves related to broadcasting.
Digital output interface	A generic name for output interfaces where signals related to output contents are broadcast as digital signals without conversion or signals converted into another digital coding scheme.
Input interface	A generic name for interfaces that are used when receivers receive signals from broadcast waves or externally connected devices.

6.3 Ensuring consistency with the entire system of server-type broadcasting

As mentioned in Section 6.1, "Scope of discussion in this interim report", the scheme summarized in this interim report is supposed to be compatible with receivers that are already in wide use. Thus, consistency of the scheme with the entire system of server-type broadcasting is ensured by the following approaches.

- 1) Protection of rights on contents is achieved by providing additional functions to the existing broadcasting system.

The additional functions are limited to those that can be implemented by modifying the software installed in the BS digital broadcast receivers. There should be no problem even when contents are received by receivers not compatible with the scheme presented in this interim report. Furthermore, reception of contents using existing schemes should not be affected even when receivers are made compatible with the scheme presented in this interim report (ensuring both backward and forward compatibility).

- 2) The rights protection scheme presented in this interim report should be made applicable to the entire system of server-type broadcasting by providing additional functions.

Because the rights protection scheme presented in this interim report will become a subset of the scheme applicable to the entire system of server-type broadcasting, any receivers compatible with server-type broadcasting should also be compatible with the scheme presented in this interim report.

6.4 Consistency with requirements

Among the requirements described in Section 3, "Setting requirements on server-type broadcasting system", the requirements applicable to the scheme presented in this interim report are "A. General requirements" and "C. Requirements on the scheme of protecting rights on contents". The satisfactoriness of the scheme presented in this interim report in light of these requirements are summarized in Table 6-2.

6.5 Assumed receivers and transmitters

6.5.1 Assumed receivers

The reference model of assumed receiver is described below together with the receiver's content accumulation functions and interfaces whose operations are to be restricted for rights protection.

6.5.1.1 Reference model of receiver

The reference model of receiver is shown in Fig. 6-1.

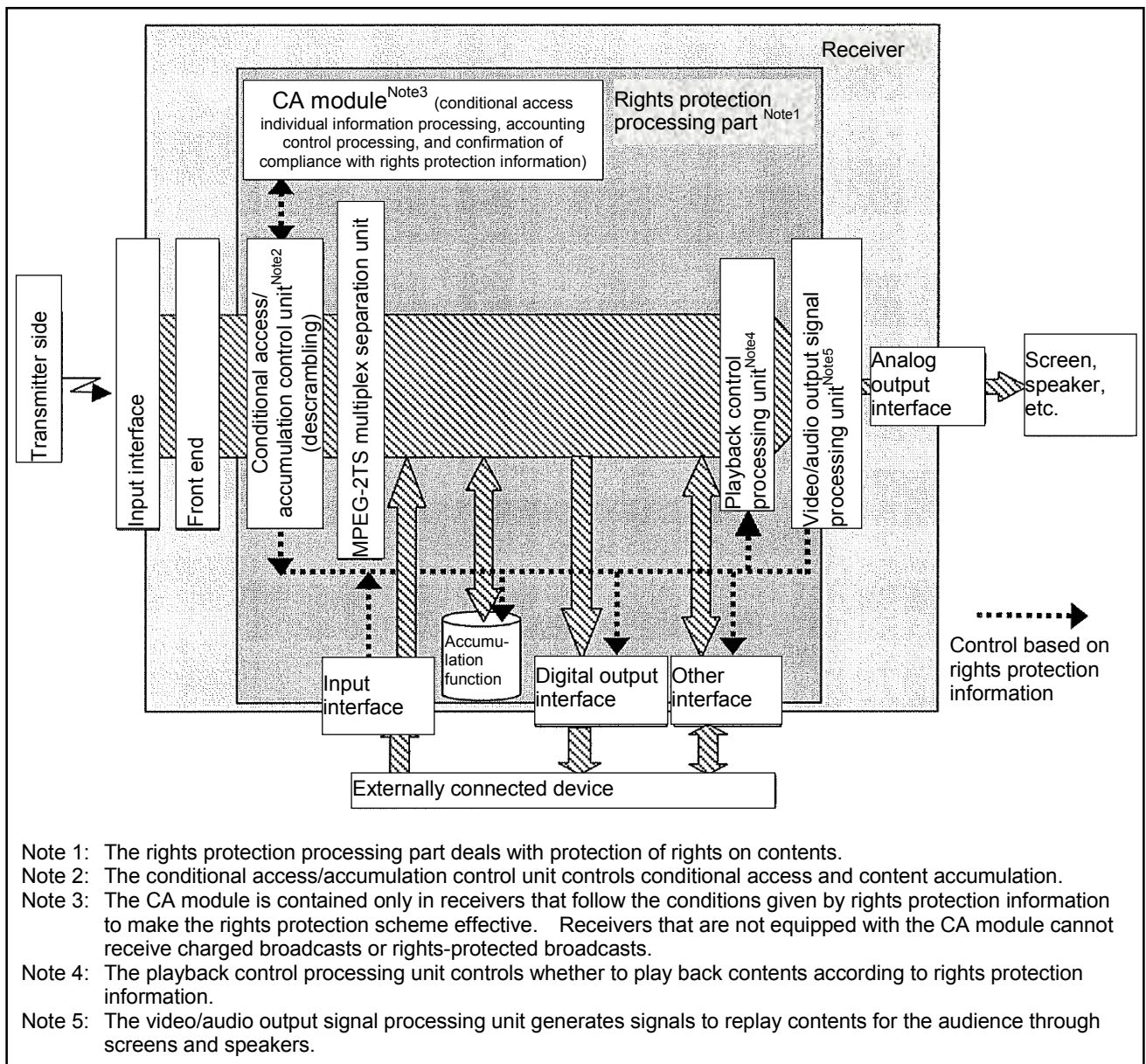

Fig. 6-1 Reference model of receiver

6.5.1.2 Content accumulation functions on the receiver side

Receivers or externally connected devices shall have the following functions of content

accumulation:

- (1) Accumulation media, such as hard disk recorders, cannot be removed from receivers or externally connected devices
- (2) Accumulation media can be removed from receivers or externally connected devices, and contents can be played back in devices other than the receivers or externally connected devices in which the contents were accumulated. Some examples are:
 - D-VHS and other types of video cassette recorders (VCRs)
 - Removable video disk recorders such as recordable DVD media
 - Removable semiconductor memories such as smart media and memory sticks

6.5.1.3 Interfaces on the receiver side

The following interfaces are assumed to be incorporated.

- (1) Input interface

Antenna terminals from which broadcast waves are input, and IEEE1394 through which signals from externally connected devices are input

- (2) Analog output interface

- A. Analog video output interface

D terminals as per the EIAJ CP-4120 and EIAJ RC-5237 standards, and S terminals and composite video terminals as per the EIAJ CPR-1201 standard

- B. Analog video output interface

RCA jack and stereo mini jack stereo audio terminals as per the EIAJ CPR-1201 standard

- (3) Digital output interface

- A. Digital video output interface

IEEE1394

- B. Digital audio output interface

Digital audio terminals as per the IEEE1394 and EIAJ CPX-4141 standards

- (4) Other interfaces

- A. Network connection interface

Some examples of network connection interfaces are:

- 10BASE-T/100BASE-TX
- Wireless LAN (ARIB RCR-STD-33/RCR-STD-T66)

The network connection interface has the following characteristic: when a receiver is

connected to an externally connected device through the interface, the receiver can communicate with other devices through the externally connected device but the type of devices to communicate with cannot be restricted.

B. Other interfaces

Interfaces other than the input interface, analog output interface, digital output interface, and network connection interface may be introduced to enhance receiver functions by

connecting externally connected devices with receivers. Some examples are:

- Interfaces to enhance the accumulation functions embedded in receivers (SCSI, IDE, USP, etc.)
- Board interfaces to add functions to receivers (PIC, PCMCIA, etc.)
- Interfaces to connect externally connected devices such as a mouse and keyboard so that users can give instructions to receivers (PS/2 connector, USB, etc.)

6.5.2 Assumed transmitters

The reference model of transmitter is shown in Fig. 6-2.

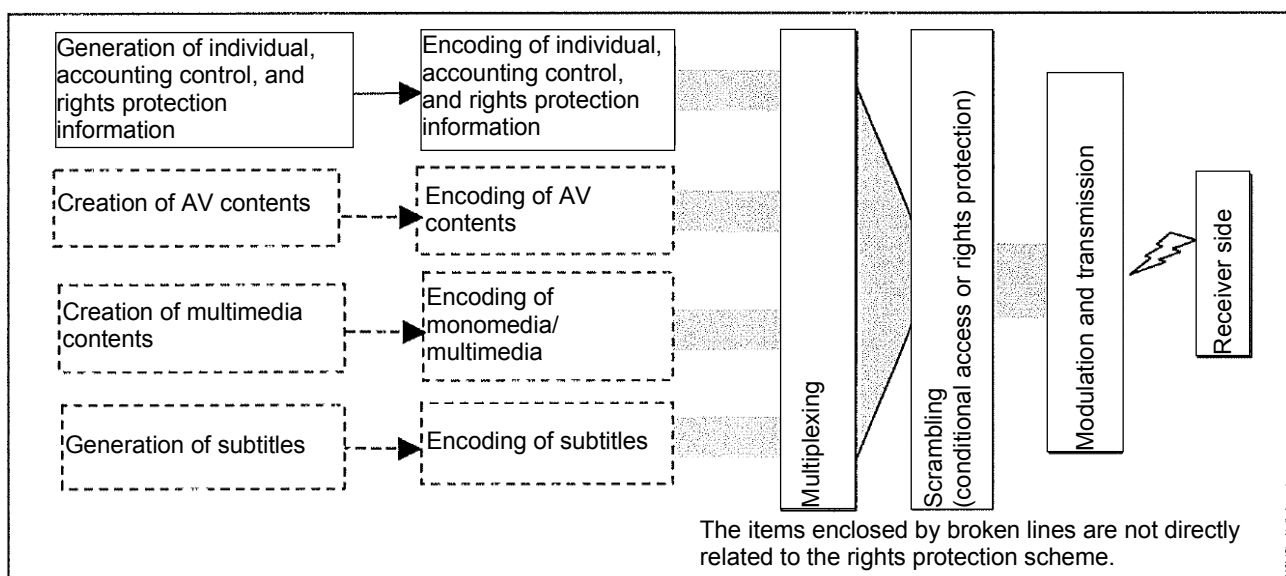

Fig. 6-2 Reference model of transmitter

6.6 Technical conditions on the content rights protection scheme compatible with BS digital broadcast receivers

6.6.1 General technical conditions on broadcast systems

The broadcast systems shall be standard systems or those specified in the Radio Station Operation

Rules (Rule No. 18 of the Radio Regulatory Committee 1950) and its related Notifications as well as in Telecommunications Technology Council partial report on the "Technical Conditions on Digital Satellite Audio Broadcasting System Using 2.6-GHz Frequency Band Radio Wave" in Consultation No. 74 "Technical Conditions on Digital Broadcasting Systems" (hereinafter referred to as "TTC's Report on Digital Satellite Audio Broadcasting").

6.6.2 Rights protection information

This information is required for protecting rights on contents. In consideration of future extensions, it is desirable that this information be handled flexibly by non-official standardization organizations.

6.6.2.1 Encoding method

As an encoding method of rights protection information, a method compatible with DTCP, which is a widely accepted approach for rights protection when digital broadcast receivers and externally connected devices are connected, is adopted, so that information is encoded as the digital copy control descriptor and the content availability descriptor. This allows DTCP-compliant digital broadcast receivers and externally connected devices, which are already in wide use, to become compatible with the scheme presented in this interim report without taking a drastic measure. Each receiver or externally connected device is required to protect contents according to the conditions given by rights protection information encoded as per the method described here, by using methods appropriate for the output interfaces and accumulation functions used when delivering content-related signals.

(1) Digital copy control descriptor

A. Configuration of digital copy control descriptor

The digital copy control descriptor, which shows information to control the reproduction of contents by the content accumulation functions of receivers or externally connected devices, is used by the right holder of the contents to send information related to the content reproduction to the receivers. The descriptor, whose configuration is shown in Table 6-3, is now being used as a non-official standard specification on digital broadcasting systems.

Table 6-3 Configuration of digital copy control descriptor

Data structure	Number of bits	Representation of bit string
digital_copy_control_descriptor(){		
descriptor_tag	8	uimsbf
descriptor_length	8	uimsbf
digital_recording_control_data	2	bslbf
private_data	4	bslbf
APS_control_data	2	bslbf
for(i=0;i<N;i++){		
private_data	8	uimsbf
}		
}		

B. Meaning of digital copy control descriptor

1) digital_recording_control_data (digital copy control information)

This 2-bit field, whose coding follows Table 6-4, shows information to control copy generation when accumulating broadcast contents as digital signals without conversion.

Table 6-4 Digital copy control information

Digital copy control information	Meaning
00	Copy possible without restriction
01	Defined arbitrarily by users
10	Copy possible for only one generation ^{Note}
11	Copy prohibited

Note: Received contents can be accumulated but the accumulated contents cannot be further reproduced; first-generation copies are allowed but second-generation are not. However, contents can be reproduced in a way multiple copies do not remain at the same time (referred to as "move").

2) APS_control_data (analog output copy control information)

This 2-bit field, whose coding follows Table 6-5, shows information to control copy generation when accumulating broadcast contents after converting them into analog signals.

Table 6-5 Analog output copy control information

Analog output copy control information	Meaning
00	Copy possible without restriction
Other than 00	Copy prohibited

(2) Content availability descriptor

A. Configuration of content availability descriptor

A new descriptor is defined as a content availability descriptor, which shows information to control accumulation and output. The content availability descriptor, whose configuration is shown in Table 6-6, is used in combination with the digital copy control descriptor by the right holder of contents to control their accumulation and output. Digital broadcast receivers that are not compatible with this information will be made compatible by modifying internal software through broadcasting etc.

Table 6-6 Configuration of content availability descriptor

Data structure	Number of bits	Representation of bit string
content_availability_descriptor(){		
descriptor_tag	8	uimsbf
descriptor_length	8	uimsbf
reserved_future_use	3	bslbf
retention_mode	1	bslbf
retention_state	3	bslbf
encryption_mode	1	bslbf
for(i=0;i<N;i++){		
reserved_futre_use	8	uimsbf
}		
}		

B. Meaning of content availability descriptor

1) retention_mode (temporal accumulation control bit)

When this 1-bit field is "0", temporal accumulation is possible even if copy is prohibited by the digital_recording_control_data of the digital copy control descriptor. When this field is "1", temporal accumulation is not possible.

2) retention_state (allowable time of temporal accumulation)

This 3-bit field, whose coding is shown in Table 6-7, indicates the allowable time of temporal accumulation after the reception of contents.

Table 6-7 Allowable time of temporal accumulation

Allowable time of temporal accumulation	Meaning
111	1 hour and 30 minutes
110	3 hours
101	6 hours
100	12 hours
011	1 day
010	2 days
001	1 week
000	No restriction

3) encryption_mode (output protection bit)

This 1-bit field indicates whether the output of high-speed digital interface is protected. When this field is "0", contents must be protected regardless of the fields of the digital copy control descriptor and the other fields of the content availability descriptor. When this field is "1", instructions given by the fields of the digital copy control descriptor and the other fields of the content availability descriptor must be followed.

4) reserved_future_use (area reserved for future use)

This field is reserved for future functional extensions to the rights protection scheme.

6.6.2.2 Transmission method

The digital copy control descriptor and the content availability descriptor shall be transmitted through the area to write transmission control signal descriptors specified in Section 2 of Article 3 of the Standard Method and the Notification No. 865 of the Ministry of Posts and Telecommunications in 1999 (TTC's Report on Digital Satellite Audio Broadcasting in the case of digital satellite audio broadcasting using 2.6-GHz frequency band radio wave).

It is specified in non-official standards that, in BS digital broadcast receivers, the signal

transmitted through the area to write transmission control signal descriptors is ignored when the descriptor tag (descriptor_tag) of the signal is different from the tag assigned to the descriptor with which the applicable receiver is already compatible. Therefore, BS digital broadcast receivers will have no problem as long as the digital copy control descriptor conforms to the existing non-official standards and the content availability descriptor is different from the existing descriptors including those of non-official standards.

6.6.3 Enforcement

With the rights protection information defined in Section 6.6.2, right holders can convey the conditions of content accumulation and copying to receivers.

However, even when contents are transmitted with rights protection information, multiple copies may be produced and distributed illegally by using devices that ignore the rights protection information (“nonreactive devices”) if they can be produced generally.

To ensure rights protection, therefore, a mechanism that does not allow demodulation of contents by nonreactive devices and reception of contents from other devices must be introduced in addition to transmitting rights protection information.

Because this mechanism is very difficult to realize by pure technical means when the “compatibility of existing receivers” is assumed, the scheme presented in this interim report ensures rights protection by the following enforcement measures:

- 1) A “technical measure” is introduced so that contents cannot be demodulated without receiving “technical information” from the right holder;
- 2) When delivering “technical information”, a “contract” or the like between the right holder and the receiver manufacturer shall clearly stipulate that the receivers manufactured by using the “technical information” should function according to the conditions given by the rights protection information.

A combined use of “technical means” and “contracts” for enforcement is generally practiced when distributing contents as packaged media. A typical case is to adopt “content encryption” as a “technical means” because of its effectiveness and convenience, and an “encryption key” as “technical information”.

With the combined use of “content encryption” and “delivery of rights protection information”, it is practically impossible to copy contents without complying to the conditions given by the rights protection information. This approach, which may be regarded as the “means of technical

protection” specified in No. 20 of Article 2 of the Copyright Law (Law No. 48 in 1970) and the “means of technical restriction” specified in the Unfair Competition Prevention Law (Law No. 47 in 1993), facilitates prevention of illegal copying.

In the scheme presented in this interim report, therefore, the “content encryption” and “encryption key” are made available as a “technical means” and “technical information”, respectively, for achieving enforcement.

6.6.3.1 Technical means to assure enforcement

Because the only way of “content encryption” compatible with existing digital broadcast receivers is the conditional access method, the scheme presented in this interim report uses the conditional access method specified in Articles 3 and 4 of the Standard Method as a technical means to assure enforcement (the method described in "2.4 Conditional access method" of TTC's Report on Digital Satellite Audio Broadcasting in the case of digital satellite audio broadcasting using 2.6-GHz frequency band radio wave).

In the current conditional access method, which intends to “allow demodulation only by the receivers covered by a contract”, contents can be demodulated only by the receivers whose assigned “individual numbers” are known to the broadcasting service provider. However, the providers of uncharged broadcasting services do not necessarily have to know the individual information of receivers. In uncharged broadcasting, therefore, an approach without discriminating individual receivers is allowed by using part of the conditional access method as described in Sections 6.6.3.2 and 6.6.3.3.

6.6.3.2 Scramble system

The scramble system used as a technical means to assure enforcement is schematically shown in Fig. 6-3. Switched use of this system on the basis of contents and broadcasting service providers is possible.

When individual receivers are not discriminated in the scramble system, the master key (Km) and contract information (the shaded region in the figure), which is specific to each receiver, is basically not used, and the work key (Kw), which is “technical information” managed by the right holder, is stored beforehand in the CA module of each receiver. While Kw is usually not transmitted, the right holder transmits a new work key to make a change to all the receivers in

case K_w is deciphered by a third person. In such a case, K_m , which is a master key specific to each receiver, is used to encrypt K_w .

Enforcement is ensured by allowing the “CA module” in Fig. 6-3 to be embedded, according to contracts etc., only in the receivers that function as per the conditions given by the rights protection information.

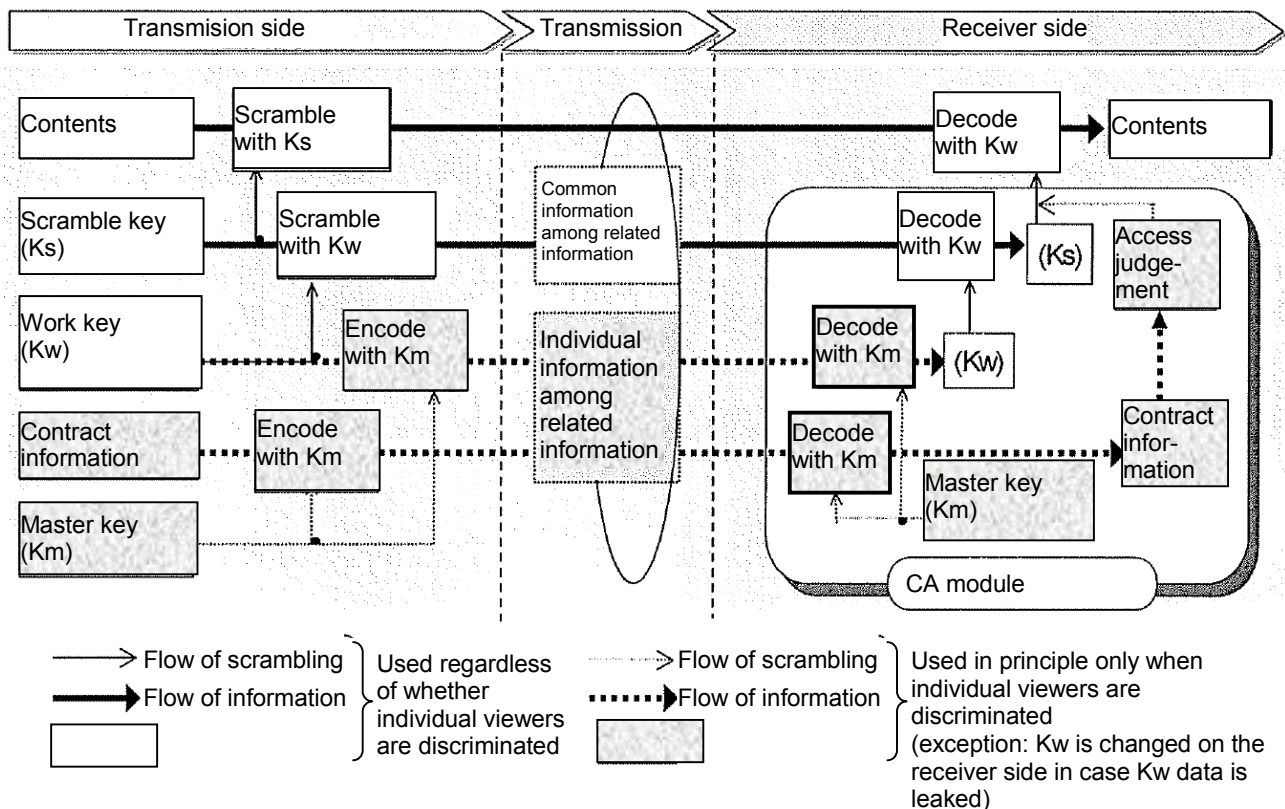

Fig. 6-3 Scramble system as a technical means to assure enforcement

6.6.3.3 Related information

(1) Common information

The common information shall send the scramble key (K_s) for descrambling and information to control switching of receiver descrambling functions to all receivers. The configuration and the delivery procedure of common information shall comply with the common information described in the Notification No. 865 of the Ministry of Posts and Telecommunications in 1999 (ECM or ECM-S described in "2.4 Conditional access method" of TTC's Report on Digital Satellite Audio Broadcasting in the case of digital satellite audio broadcasting using 2.6-GHz frequency band radio wave).

(2) Individual information

The individual information shall send the work key (Kw) or universally known information on content protection to individual receivers. The configuration and the delivery procedure of individual information shall comply with the individual information described in the Notification No. 865 of the Ministry of Posts and Telecommunications in 1999 (EMM or EMM-S described in "2.4 Conditional access method" of TTC's Report on Digital Satellite Audio Broadcasting in the case of digital satellite audio broadcasting using 2.6-GHz frequency band radio wave).

When individual receivers are not discriminated, individual information is transmitted only when changing the work key (Kw) or sending universally known information on content protection to individual receivers.

6.6.4 Exemplified usage of the rights protection scheme

Examples of receiver operation complying with the rights protection information described in Section 6.6.2 and the enforcement measures described in Section 6.6.3 are shown in Reference 1. In addition, examples of operation in protecting content rights using the rights protection information described in Section 6.6.2 are shown in Reference 2.

7. Next challenges

In the future, a new content supply method and an access control method will be considered for the server-type broadcasting system, and the rights protection scheme applicable to the entire system of server-type broadcasting will be pursued continually.

V. Results of consultation

Among the technical conditions on digital broadcasting systems using large-volume accumulating functions, technical conditions on the rights protection scheme compatible with BS digital broadcast receivers are summarized in the partial report (proposal) attached to this document

Reference 1

Examples of receiver operation complying with the rights protection scheme

Receivers are expected to operate as described below in the "rights protection scheme compatible with BS digital broadcast receivers."

A.1 Basic conditions

Accumulation and replay of contents by the content accumulation devices embedded in receivers must comply with the conditions given by the rights protection information described in Section 6.6.2 of IV of the interim report. When removable media are embedded in receivers, not only the broadcast receivers but also all devices that can replay the contents accumulated in the media must operate in accordance with the conditions given by the rights protection information.

Considering content accumulation by externally connected devices, signal output to each output interface shall be carried out in a way contents can be received only by the devices that are ensured to operate in accordance with the conditions given by the rights protection information. Operational details are described in A.2.

A.2 Receiver operations according to the conditions given by rights protection information

Upon receiving rights protection information, the receiver protects contents accumulated in its embedded accumulation function, including protection against accumulation functions connected externally to the receiver. For this purpose, the receiver is expected to operate in a way described below at the outputs of the analog video output interface, IEEE1394, and digital audio terminal. Receiver operations regarding other interfaces are described in "A.3 Robustness rules".

A.2.1 Operation according to digital copy control descriptor

When contents with a digital copy control descriptor are input from the antenna terminal, the receiver shall operate according to the conditions specified in the digital copy control descriptor and the content availability descriptor. When contents with signals corresponding to a digital copy control descriptor are input from the IEEE1394 interface, the receiver shall operate according to the signals corresponding to the digital copy control descriptor and the content availability

descriptor.

When contents without a digital copy control descriptor or signals corresponding to it are input, the receiver does not have to comply with the content availability descriptor or signals corresponding to it.

A.2.1.1 Digital copy control information

When "00" is input as a signal corresponding to digital copy control information, no particular response is required.

When "10" is input, the applicable contents can be copied for only one generation, and the following operations are expected:

- When accumulating contents in the accumulation function embedded in the receiver (hereinafter referred to as the "embedded accumulation device"), the setting of "copy possible for only one generation" shall be changed to "recopy prohibited". While "01" means "defined arbitrarily by the user" in the digital copy control information, it can be used for meaning "recopy prohibited".
- As for IEEE1394 output, if the connected device can be confirmed to operate under the condition of "copy possible for only one generation" (e.g., a device that accumulates contents under the condition of "recopy prohibited" or that without an accumulation function), contents can be transmitted in a way they can be received only by this device.
- As for the output of analog video output interface, signals that can be copied for only one generation are added and output as CGMS-A (Copy Generation Management System in which copy control information is superimposed during the vertical blanking interval of analog video output signals) data.
- As for digital audio terminal output, signals that can be copied for only one generation are added and output as SCMS (Serial Copy Management System in which copy control information is superimposed on digital audio signals) data.

When "11" is input, the applicable contents are "copy prohibited", and the following operations are expected:

- Contents are not accumulated in the embedded accumulation device.
- As for IEEE1394 output, if the connected device can be confirmed to operate under the condition of "copy prohibited" (e.g., a device without an accumulation function), contents can be transmitted in a way they can be received only by this device.
- As for the output of analog video output interface, copy-prohibited signals are added and output as CGMS-A data.
- As for digital audio terminal output, copy-prohibited signals are added and output as SCMS data.

When "01" is input from the antenna terminal, receiver operation is not specified because the code means "defined arbitrarily by the user". When a signal corresponding to "01" is input from IEEE1394, the applicable contents are treated as "recopy prohibited", and the following operations

are expected:

- Contents are not accumulated in the embedded accumulation device.
- As for IEEE1394 output, if the connected device can be confirmed to operate under the condition of "recopy prohibited" (e.g., a device without an accumulation function), contents can be transmitted in a way they can be received only by this device.
- As for the output of analog video output interface, copy-prohibited signals are added and output as CGMS-A data.
- As for digital audio terminal output, copy-prohibited signals are added and output as SCMS data.

A.2.1.2 Analog output copy control information

When "00" is input as a signal corresponding to analog output copy control information, no particular response is required.

When another type of signal is input, output data from the analog video output interface is protected so that recording by usual VCRs is prevented.

A.2.2 Receiver operations according to content availability descriptor

A.2.2.1 Temporal accumulation control bit and the allowable time of temporal accumulation

When "0" is input as a signal corresponding to the temporal accumulation control bit, the following operations are expected regardless of the signal corresponding to the digital copy control descriptor:

- Contents can be accumulated in the embedded accumulation device. However, contents must be incapable of replaying after the passage of the allowable time of temporal accumulation.
- As for IEEE1394 output, if the connected device can be confirmed to be incapable of replaying the applicable contents after the passage of the allowable time of temporal accumulation (e.g., a device compatible with temporal accumulation or that without an accumulation function), contents can be transmitted to this device.

When the temporal accumulation control bit is unknown, it is treated as "0" (temporal accumulation possible). When the allowable time of temporal accumulation is unknown, it is treated as "111" (1 hour and 30 minutes).

A.2.2.2 Output protection bit

When "0" is input as a signal corresponding to the output protection bit, the applicable contents need to be protected from illegal digital copying regardless of the signal corresponding to the digital copy control descriptor, and the following operations are expected:

- When the digital copy control information is not "00", the instruction given by the digital copy control information shall be followed.
- When digital copy control information is "00" and when contents are output from IEEE1394 or the digital audio terminal, the contents shall be in a form that cannot be received regardless of the descriptions in Section A2.1.1, unless the connected device is certified to operate according to the conditions given by the rights protection information. Furthermore, if IEEE1394 output signals are in MPEG-2TS format, they shall be encrypted before transmission so that they cannot be received by other devices.

A.3 Robustness rules

When a receiver operates as described in Section A.2 according to the conditions given by the rights protection information, unconscious, illegal copying of contents by the user of the receiver can be prevented.

However, further measures are required as described below to protect contents from conscious, illegal copying.

A.3.1 Relaxation of copy restriction

The digital copy control descriptor etc. allow only three states of copy restriction: copy possible without restriction, copy possible for only one generation, and copy prohibited. Therefore, copy-controlled contents (other than contents of "copy possible without restriction") once accumulated are difficult to replay in another device. In particular, when contents are accumulated in a hard disk recorder, in which replacement of accumulation media is difficult, storage of contents becomes more difficult compared to video cassettes and DVDs. This situation may represent a remote cause of illegal copying.

Because the intention of allowing copies for only one generation is to prevent generation of many copies from one accumulation, recopying does not have to be prevented if only one copy can be used at any time. Therefore, reproduction of recopy-prohibited contents may be permitted if multiple copies that can be replayed do not remain at the same time (this operation is referred to as "move"). It is considered that this approach reduces the possibility of rights protection becoming a remote cause of illegal copying.

Regarding recopy-prohibited contents accumulated in an embedded accumulation device, the following operations are expected:

- Contents can be copied as "recopy prohibited" in other embedded accumulation devices. It should be noted in the copying that contents that can be replayed should not remain in different embedded accumulation devices at the same time.
- As for IEEE1394 and digital audio terminal output, contents can be transmitted to a connected device that is "move" compatible even if it has an accumulation function. It should be noted in this case that contents that can be replayed should not remain in both the embedded accumulation device and the externally connected accumulation device at the same time. Encryption and other conditions shall conform to Section A2.1.1.

When a signal corresponding to "recopy prohibited" is input from IEEE1394, and the externally connected device sending the signal is compatible with "move":

- Contents can be copied as "recopy prohibited" in the embedded accumulation device. Contents that can be replayed should not remain in different accumulation devices (either embedded or externally connected) at the same time.
- As for IEEE1394 and digital audio terminals, contents can be transmitted to a connected device that is "move" compatible even if it has an accumulation function. In this case, contents that can be replayed should not remain in both the embedded accumulation device and the externally connected accumulation device at the same time. Encryption and other conditions shall conform to Section A2.1.1.

A.3.2 Rules for other interfaces

Rights protection described below shall be applied to interfaces other than those specified in

Section A.2. Such interfaces are in either of two states:

- The digital copy control information is not "00" (copy possible without restriction);
- The digital copy control information is "00" and the output protection bit is "0".

A.3.2.1 Analog audio output interface

The output of analog audio output interface is not specified because it is difficult to implement an effective measure of rights protection in this regard. However, functions that contradicts the rights protection information, such as a function to allow automatic reproduction of audio signals, shall not be embedded in the receiver.

A.3.2.2 Network connection interface

As for IEEE1394 operations, the same protection as that specified in Section A.2 must be provided. This means when contents are output to the applicable interface, they must be in a form receivable only by those devices that operate according to the conditions given by the rights protection information.

On the Internet, therefore, contents cannot be re-transmitted unless a system assured to be compliant with the conditions given by the rights protection information is used.

A.3.2.3 Other interface

When contents are output through all the other types of interfaces, the same protection as that specified in Section A.2 must be provided. This means when contents are output to the applicable interface, they must be in a form receivable only by those devices that operate according to the conditions given by the rights protection information.

A.3.3 Standard receiver functions

The functions implemented in each receiver must in principle be determined by the parties who design and manufacture the receiver.

To assure that rights are protected according to the conditions given by the rights protection information, however, sufficient rights protection functions must be implemented so as to effectively prevent attempts to break or evade rights protection. Some requirements in this regard are described below.

A.3.3.1 Basic requirements of functions

The receiver must be designed and manufactured so that its rights protection functions including output and copy control cannot be breached easily.

The receiver must be designed and manufactured so that illegal extraction, alteration, or copy of rights-protected information is difficult to conduct.

The receiver must be designed and manufactured so that none of the closed information for protecting received contents can be extracted by external parties.

A.3.3.2 Method of content accumulation

When accumulating contents with the digital copy control information being not "00" (copy possible without restriction) or with the digital copy control information being "00" and the output protection bit being "0", the information accumulated in the accumulation media must be encrypted somehow regardless of whether the accumulation function is within in the receiver or the externally connected device. Even if the accumulated information is extracted illegally, the contents shall be in a form incapable of replaying.

If the encryption algorithm and the key used for encoding or decoding are closed information, they should be maintained appropriately and kept secret from the users.

Examples of protecting content rights

The rights protection information specified in Section 6.6.2 of IV of the interim report controls independently various restrictions on the use of contents. Using this information, rights protection shall be carried out appropriately while avoiding unreasonable restriction on the use of contents.

Favorable examples of operation are described below.

B.1 Relationship between service type and rights protection

There appears to be a close relationship between the type of service and the necessity of rights protection such as copy control.

For example, viewers can accumulate contents within the scope of personal use in the case of broadcasting services without a scheme of rights protection. In broadcasting services with a rights protection scheme, on the other hand, it appears unfavorable to make contents "copy prohibited" because prohibiting viewers from any accumulation of contents is unreasonable.

The situation may be different in the case of a pay-per-view service, which intends to charge viewers every time they access the service. If accumulation of contents by viewers itself is unwanted, it may be unavoidable to broadcast "copy-prohibited" contents.

When there are enforcement measures, contents that do not use the measures may be received by receivers that do not comply with the conditions given by the rights protection information and could be copied illegally. On the other hand, the viewers using receivers that operate according to the conditions given by the rights protection information are restricted in copying the contents. Because of this unreasonableness, any restriction on copying is considered to be unfavorable.

The relationship between the type of service and the rights protection information such as copy control is referred to as an "encoding rule", which should be properly set by the parties who conduct content rights protection. As an example, a DTCP-based encoding rule is shown in Table B-1.

Table B-1 Example of encoding rule

Service type	Copy generation control using the digital copy control information
Pay-per-view	Copy possible without restriction, copy possible for only one generation, or copy prohibited
Charged broadcasting (e.g. monthly)	Copy possible without restriction or copy possible for only one generation
Other types of broadcasting involving enforcement	Copy possible without restriction or copy possible for only one generation
Other than the above types	Copy possible without restriction

B.2 Relationship between digital copy control and analog output copy control

Digital copy control and analog output copy control are both intended for restricting copy. They respectively deal with digital accumulation devices, in which contents are accumulated as digital signals without conversion, and analog accumulation devices, in which contents are accumulated after conversion into analog signals.

Digital accumulation devices, which accumulate contents while preserving image and sound quality as they were broadcasted, are considered to be a greater threat to rights protection than analog accumulation devices, in which image and sound quality is degraded by conversion into analog signals.

It is therefore reasonable to make analog output copy control less restrictive than digital copy control. Analog output copy control should be restricted to the case where digital copy control is "11" (copy prohibited) or "recopy prohibited".

Annex 2

This Annex contains excerpts from the following report published on September 30, 2002. Refer to the original report as necessary.

Fiscal 2002

Report of the Telecommunications Council

Consultation No. 2003

"Technical Conditions on Digital Broadcasting Systems Using Large-Volume Accumulating Functions"

September 30, 2002

Chapter 3 Technical conditions on rights protection information

1. Enforcement

It is appropriate to keep adopting the idea of enforcement described in the "Interim Report of the Committee on Server-Type Broadcasting Systems" issued on March 13 (herein after referred to as the interim report).

To enable rights protection, therefore, the following measures shall be taken:

- 1) A technical measure is introduced so that contents cannot be demodulated without receiving technical information from the right holder;
- 2) When delivering technical information, a contract or the like, stipulating that the receivers manufactured by using the technical information should function according to the conditions given by the rights protection information, shall be concluded between the right holder and the receiver manufacturer.

An appropriate way to assure the enforcement is to adopt content encryption as a technical means and the encryption key as technical information.

It is appropriate to make available not only the scrambling method described in the interim report but also all the encryption methods for access control shown in Chapter 4.

The enforcement does not affect devices that accumulate contents and meta-data without decoding. Thus, it is desirable to stipulate in a contract between the right holder and the receiver manufacturer that the receiver does not replay contents that are input from such a device.

2. Rights protection information

Rights protection information showing the conditions of using contents and meta-data shall be in the scheme described below.

2.1 Rights protection information by transmission control signals

Although it is desirable that rights protection information by transmission control signals be compliant with this section, it is still appropriate to allow arbitrary transmission methods as is the case with the interim report in view of ensuring the extensibility of the rights protection scheme.

2.1.1 Digital copy control descriptor

2.1.1.1 Data structure of digital copy control descriptor

The digital copy control descriptor, which contains information to control reproduction of contents by the content accumulation functions of receivers or externally connected devices, is used by the right holder of the contents to send information on content reproduction to the receivers. The

data structure of the descriptor is shown in Table 3-3-1.

Table 3-3-1 Data structure of digital copy control descriptor

Data structure	Number of bits	Representation of bit string
digital_copy_control_descriptor(){		
descriptor_tag	8	uimsbf
descriptor_length	8	uimsbf
digital_recording_control_data	2	bslbf
private_data	4	bslbf
APS_control_data	2	bslbf
for(i=0;i<N;i++){		
private_data	8	uimsbf
}		
}		

2.1.1.2 Meaning of digital copy control descriptor

(1) digital_recording_control_data (digital copy control information)

This 2-bit field, whose coding follows Table 3-3-2, shows information to control copy generation when accumulating broadcast contents as digital signals on the partial TS level (step (2) in Fig. 3-3-1).

As for receivers that are not compatible with extension_data in the content availability descriptor shown in Section 2.1.2, copy generation shall be controlled according to the condition given by this field regardless of the playback step of output contents.

Table 3-3-2 Digital copy control information

Digital copy control information	Description
00	Copy possible without restriction
01	Defined arbitrarily by the user
10	Copy possible for only one generation*
11	Copy prohibited

Note: Received contents can be accumulated but the accumulated contents cannot be reproduced furthermore; first-generation copies are allowed but second-generation are not. However, contents can be reproduced in a way multiple copies do not remain at the same time (referred to as "move").

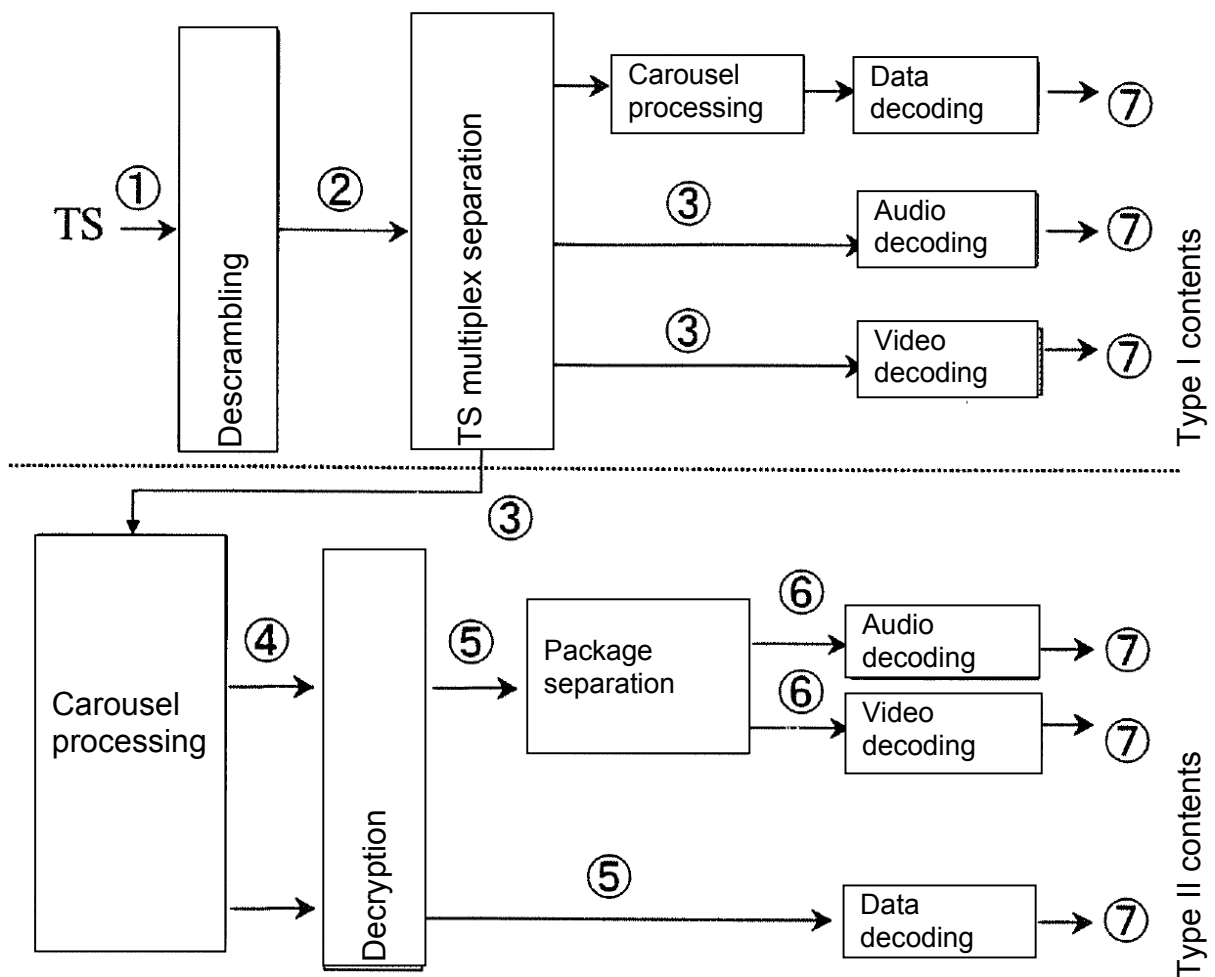

Fig. 3-3-1 Exemplified processing of content playback in receiver

(2) APS_control_data (analog output copy control information)

This 2-bit field, whose coding follows Table 3-3-3, shows information to control copy generation when accumulating broadcast contents after converting them into analog signals.

Table 3-3-3 Analog output copy control information

Analog output copy control information	Description
00	Copy possible without restriction
Other than 0	Copy prohibited

2.1.2 Content availability descriptor

2.1.2.1 Data structure of content availability descriptor

The content availability descriptor, whose data structure is shown in Table 3-3-4, describes rights protection information other than that covered by the digital copy control descriptor.

Table 3-3-4 Data structure of content availability descriptor

Data structure	Number of bits	Representation of bit string
content_availability_descriptor(){		
descriptor_tag	8	uimsbf
descriptor_length	8	uimsbf
private_data	3	bslbf
retention_mode	1	bslbf
retention_state	3	bslbf
encryption_mode	1	bslbf
for(i=0;i<N;i++){		
extention_data	8	bslbf
}		
}		

2.1.2.2 Meaning of content availability descriptor

(1) retention_mode (temporal accumulation control bit)

When this 1-bit field is "0", temporal accumulation is possible on the partial TS level even if copy is prohibited by the digital_recording_control_data of the digital copy control descriptor. When this field is "1", temporal accumulation is not possible on the partial TS level.

As for receivers that do not support extension_data in the content availability descriptor within this descriptor, temporal accumulation shall be controlled according to the condition given by this field regardless of the playback step of output contents.

(2) retention_state (allowable time of temporal accumulation)

This 3-bit field, whose coding is shown in Table 3-3-5, indicates the allowable time of temporal accumulation after the reception of contents on the partial TS level.

As for receivers that do not support extension_data in the content availability descriptor within this descriptor, accumulation shall be controlled according to the condition given by this field regardless of the playback step of output contents.

Table 3-3-5 Allowable time of temporal accumulation

Allowable time of temporal accumulation	Meaning
111	1 hour and 30 minutes
110	3 hours
101	6 hours
100	12 hours
011	1 day
010	2 days
001	1 week
000	No restriction

(3) encryption_mode (output protection bit)

This 1-bit field indicates whether the output of high-speed digital interface is protected on the partial TS level. When this field is "0", contents must be protected regardless of the fields of

the digital copy control descriptor and the other fields of the content availability descriptor. When this field is "1", instructions given by the fields of the digital copy control descriptor and the other fields of the content availability descriptor must be followed.

As for receivers that do not support extension_data in the content availability descriptor within this descriptor, output shall be protected according to the condition given by this field regardless of the playback step of output contents.

(4) extension_data (extension information)

This field, whose data structure is shown in Table 3-3-6, is used for setting rights protection information for each step of content playback.

Table 3-3-6 Data structure of extension information

Data structure	Number of bits	Representation of bit string
<pre> extension_data(){ control_level_loop_count for(j=0;j<M;j++){ control_level control_data_loop_length for(k=0;k<L;k++){ control_data } } } </pre>	8	uimsbf
<pre> } for(h=0;h<P;h++){ private_data_byte } } </pre>	8	bslbf

Each element in the table are described below.

- 1) control_level_loop_count (rights protection information set): This 8-bit field indicates how many types of rights protection information are contained in extension_data.
- 2) control_level (control level): This 8-bit field indicates the correspondence of the rights protection information given by control_data following control_level to the step of content playback in the receiver. The coding of this field is exemplified in Table 3-3-7.

When rights protection information is set for a certain step of content playback, the receiver shall operate during content output in further steps of playback according to the conditions given by the information unless another rights protection information is newly set.

Table 3-3-7 Example of control levels

Control level	Meaning
'00000000'	Transport stream ((1) in Fig. 3-3-1)
'00100000'	After descrambling ((2) in Fig. 3-3-1)
'01000000'	After TS multiplex separation ((3) in Fig. 3-3-1)
'01100000'	After carousel processing ((4) in Fig. 3-3-1)
'10000000'	After decryption ((5) in Fig. 3-3-1)
'10100000'	After type II package separation ((6) in Fig. 3-3-1)
'11000000'	Uncompressed digital signal ((7) in Fig. 3-3-1)
'11100000'	Analog output

- 3) `Control_data_loop_length` (length of rights protection control information): This 8-bit field indicates the byte length of `control_data` following `control_data_loop_length`.
- 4) `Control_data` (rights protection control information): This shows rights protection information on content output in the content playback step specified by `control_level`. It is appropriate that the coding method in `control_data` can be set freely according to the output interface used in the playback step.

Table 3-3-8 shows an example of data structure of rights protection control information when providing, to a certain `control_level`, rights protection control information corresponding to the digital copy control information, the temporary accumulation control bit, the allowable time of temporal accumulation, and the output protection bit.

Table 3-3-8 Example of data structure of rights protection control information

Data structure	Number of bits	Representation of bit string
extention_data(){		
control_level_loop_count	8	uimsbf
for(j=0;j<N;j++){		
control_level	8	bslbf
'0x01'(control_data_loop_length)	8	uimsbf
for(k=0;k<L;k++){		
digital_recording_control_data	2	bslbf
retention_mode	1	bslbf
retention_state	3	bslbf
encryption_mode	1	bslbf
reserved	1	bslbf
}		
}		
for(h=0;h<P;h++){		
private_data_byte	8	bslbf
}		
}		

2.1.3 Transmission method of rights protection information by transmission control signals

It is appropriate to transmit the digital copy control descriptor and the content availability descriptor in the area to write transmission control signal descriptors specified in the current technical standards.

2.2 Rights protection information by description language

Rights protection information is transmitted basically according to the transmission control signals described in Section 2.1. To allow complicated conditions of rights protection information (e.g., contents can be accumulated in household audio-video devices but cannot be accumulated when devices to receive the contents are not certain, such as the case of content output to the Internet), it is appropriate to enable expression of rights protection information by using description languages such as the right expression language (REL), being standardized as MPEG-21.

It is desirable to have different description languages available for rights protection information according to the environment where contents are used. In view of diversification of broadcasting services and extensibility of broadcasting systems, therefore, it is appropriate that description languages can be selected arbitrarily. Nevertheless, the description language of rights protection information and the transmission method are desired to be compliant with the description

language and meta-data described in Section 3.2 of Chapter 2 so that the processing part of each receiver can be standardized.

3. Maintenance of the rights protection scheme used by receivers

The necessity of the extensibility of the rights protection scheme and an approach for this purpose were discussed in Section 2 in view of making the scheme available to various receivers for content protection.

Some of the rights protection schemes for receivers require, for keeping the schemes functional, regular updating of the list of devices that circumvent illegal copy protection or information to certify that devices are compatible with the rights protection scheme (hereinafter referred to as “rights protection scheme management information”).

It is desired that rights protection scheme management information has the following characteristics:

- 1) Different transmission methods are available according to the volume of information because the amount of rights protection scheme management information varies widely with the rights protection scheme.
- 2) Some of the rights protection scheme may be implemented only in very simple receivers or receivers of very high functionality. It is therefore desirable that different transmission methods can be selected according to the functionality of the receivers that receive rights protection scheme management information.

Thus, it is appropriate that the transmission method of rights protection scheme management information can be selected arbitrarily so that the information can be transmitted in a way suited for each rights protection scheme. Described below for example are two transmission methods of rights protection scheme management information.

3.1 Transmission method of rights protection scheme management information using data carousel

Rights protection scheme management information encoded according to the specifications of each rights protection scheme is transmitted as a data carousel module according to ISO/IEC 13618-6. Here, the type of rights protection scheme management information and the corresponding rights protection scheme are identified by using the file format descriptor written in a data carousel DII (see Section 1.2.2.4 of Chapter 2). For example, receivers can identify that a System Renewability Message (SRM) is for the High-bandwidth Digital Content Protection (HDCP) system with a description like "application/X-copyprotection/HDCP/SRM" in the file format descriptor.

3.2 Transmission method of rights protection scheme management information using section format

Rights protection scheme management information encoded according to the specifications of each rights protection scheme is transmitted, as is the case with transmission control signals specified in the current technical standards, by using the extended section format specified in Section 4 of Article 3 of the Standard Method and Attached Table 4 of the Notification No. 865 of the Ministry of Posts and Telecommunications in 1999.

3.2.1 Structure of section format

An example of data structure of signals when transmitting rights protection scheme management information by the section format is shown in Table 3-3-9.

Table 3-3-9 Example of data structure of rights protection scheme management information

Data structure	Number of bits	Representation of bit string
CP_management_section(){		
table_id	8	uimsbf
section_syntax_indicator	1	bslbf
'1'	1	bslbf
'11'	2	bslbf
section_length	12	uimsbf
CP_system_id	16	uimsbf
'11'	2	bslbf
version_number	5	uimsbf
current_next_indicator	1	bslbf
section_number	8	uimsbf
last_section_number	8	uimsbf
for(i=0;i<N;i++){		
CP_management_information()	8	uimsbf
}		
CRC_32	32	rpchof
}		

Each element in the table are described below.

- 1) table_id: Indicates that the section is used for transmitting rights protection scheme management information.
- 2) section_syntax_indicator: The value of this indicator is always "1" as per the Notification No. 865 of the Ministry of Posts and Telecommunications in 1999.
- 3) section_length (section length): This field indicates the byte length of the applicable section.
- 4) CP_system_id: This field is used for identifying the rights protection scheme corresponding to the information transmitted as CP_management_information().
- 5) version_number: This field indicates the version number of CP_management_information().

- 6) `current_next_indicator`: The value of this indicator is always "1" as per the Notification No. 865 of the Ministry of Posts and Telecommunications in 1999.
- 7) `section_number`: This field indicates the section number.
- 8) `last_section_number`: This field indicates the last section number of the section used for transmitting rights protection scheme management information.
- 9) `CP_management_information()`: This field is used for writing all or part of the rights protection scheme management information for the rights protection scheme given by `CP_system_id`.
- 10) `CRC_32`: This field indicates a value calculated according to the Notification No. 865 of the Ministry of Posts and Telecommunications in 1999 and ITU-T Recommendation H.222.0.

3.2.2 Transmission method using section format

The rights protection scheme management information expressed in the section format described in Section 3.2.1 is split into 184-byte units, then written into the payload of the TS packet, and transmitted according to the TS packet transmission procedure specified in Section 4 of Article 3 of the Standard Method and Attached Table 5 of the Notification No. 865 of the Ministry of Posts and Telecommunications in 1999.

In the PID^(Note) area used to identify the type of data written in the payload of the TS packet, there must be an indication that the data is rights protection scheme management information. Based on the allocation of PID given in Table 3-3-10, it is appropriate to write any of the values specified as the "field allocated to other than PAT, CAT, or NIT" in the TS packet that transmits rights protection scheme management information.

Table 3-3-10 Allocation of PID

Value	Description
0x0000	Program association table (PAT) that relates contents and meta-data to relevant transmission control signals
0x0001	Conditional access table (CAT) that relates encoded contents and meta-data to information required to decode them
0x0002-0x000F	Undefined

Value	Description
0x0010	Transmits information on transmission lines, such as modulation frequency

Value	Description
	NIT (Network Information Table)
0x0011-0x1FFE	Field allocated to other than PAT, CAT, or NIT

0x1FFF	Null packet
--------	-------------

Note: The packet identifier (PID) provides information required to identify data transmitted by the TS packet in the MPEG-2 system.

4. Protection of meta-data against alteration, and handling of meta-data provided by third parties

4.1 Protection of meta-data against alteration

To prevent alteration of meta-data, the enforcement measures described in Section 1 of Chapter 3 are used. It is thus appropriate to prevent alteration of meta-data by allowing it to be decoded only by receivers manufactured according to a contract stipulating that meta-data transmitted in an encoded state shall not be altered after its reception.

4.2 Restriction of contents availability using meta-data provided by third parties

It is desirable that meta-data can be provided by any parties. However, contents may be accessed by using meta-data in a way undesirable to the right holder of the contents. To protect content rights, therefore, some restriction should be placed on the availability of contents through provision of meta-data.

By defining the scope of content services made available by any meta-data, contents can be made available using meta-data provided by any third party as long as the services provided are within the scope. It is appropriate, through enforcement, to deal with services beyond the scope by allowing access to contents only for meta-data that can be judged to have permission from the right holder of the contents. It is appropriate to set the "scope of content services made available by any meta-data" according to the characteristics of contents.

The following types of meta-data are judged to have permission from the right holder of the contents:

- 1) meta-data provided through the broadcasting wave of the service provider who transmitted the contents;
- 2) meta-data called by other meta-data provided through the broadcasting wave of the service provider who transmitted the contents or called by data broadcasting contents;
- 3) meta-data whose permission from the right holder of the contents can be confirmed by the method specified in other meta-data provided through the broadcasting wave of the service provider who transmitted the contents or by the method specified in data broadcasting contents.

It is appropriate to define such judgement criteria together with the aforementioned "scope of content services made available by any meta-data".

Reference 8

Digital watermarking

1. Purpose and timing of digital watermarking in broadcasting systems

There are two main purposes of digital watermarking in both analog and digital broadcasting systems:

- 1) to operate receivers based on explicit or implicit information;
- 2) to present copyright information.

In 1), receivers may be controlled to transmit various types of meta-data (URL for a program related site, rights protection information, etc.), and in 2), the information may be used as a search key to detect illegal use of contents.

There are two cases for the timing of digital watermarking:

- inserted before the contents are acquired by the broadcasting service provider;
- inserted by the broadcasting service provider within the broadcasting system.

2. Verification of effects

As for transmitting various types of meta-data with digital watermarks to operate receivers, it is more economical to operate receivers with descriptors rather than installing a digital watermark detector in the receiver because there already is an established method of transmitting multiplexed descriptors. Nevertheless, digital watermarking is an effective way to transmit received or recorded signals to analog-connection recorders. This is a matter to be discussed between the right holder of the contents and the manufacturer of the recorders.

The following effects are expected in the insertion of copyright information as a “digital watermark”:

- Potential violators may hesitate to conduct illegal copying;
- The information embedded in the digital watermark allows identification of broadcasting stations (including network stations) who broadcasted the contents.

Although the inserted information may be used as a search key to trace illegal use of contents, some say it is difficult to know something beyond "broadcast contents are illegally distributed on the network" because a large number of copies having the same “digital watermark” are generated by the broadcasting of the contents.

To achieve the above purposes effectively, it is important that information embedded as a “digital

watermark” is not easily deleted or modified.

3. Standardization of inserting method of digital watermarks

Technical methodology is required to be open to the public in general standardized technologies. In view of the expected effects of digital watermarking, however, it is not favorable to disclose information on the inserting method of digital watermarks because it might aid an attempt to modify the information embedded as digital watermarks. It is therefore desirable that each broadcasting service provider can freely select from available methods of digital watermarking (including the strength of insertion) according to the importance of embedded information.

Though it may be useful in some cases to add identification data to inform receivers of whether digital watermarks are inserted and the method of digital watermarking, there are arguments that the identification data may aid alteration and cause degradation of image quality or reliability due to double embedding. It is therefore desirable that each provider can use an arbitrary method to add information to identify digital watermarks.

Based on the above two points, it is not at present appropriate to technically standardize the method of digital watermarking.

4. On the management of digital watermarking

Because insertion of digital watermarks may cause degradation of image and sound quality, and the information embedded in the contents is not easily deleted, digital watermarks should not be used unlimitedly. Instead, they should be used only when there is sufficient necessity.

Information to be embedded by broadcasting service providers should therefore be limited, for example, to that concerned with content rights (information on the right holder and ID of the contents, etc.).

When a broadcasting service provider uses broadcast materials in which digital watermarks are inserted by another party, the provider does not know what information is embedded in what method of digital watermarking. Thus, the embedded information may be altered or deleted unintentionally by the provider during edition. It is therefore not appropriate to regulate broadcasting service providers regarding digital watermarks inserted preliminarily in broadcast materials.

When a broadcasting service provider uses broadcast materials with knowledge that digital

watermarks are inserted, information to be embedded as digital watermarks should be limited, for example, to that concerned with content rights (information on the right holder and ID of the contents, etc.).

RECEIVER FOR
DIGITAL BROADCASTING

ARIB STANDARD
(DESIRABLE SPECIFICATIONS)

ARIB STD-B21 VERSION 4.6-E1
(March 14, 2007)

This Document is based on the ARIB standard of "Receiver for Digital
Broadcasting" in Japanese edition and translated into English in
May, 2007.

Published by

Association of Radio Industries and Businesses

Nittochi Bldg. 11F
1-4-1 Kasumigaseki, Chiyoda-ku, Tokyo 100-0013, Japan

TEL 81-3-5510-8590
FAX 81-3-3592-1103

Printed in Japan
All rights reserved
